

SHINDENGEN

Super Fast Recovery Rectifiers

Single

S3L40

400V 3A

FEATURES

- Low noise
- trr50ns
- Applicable to Automatic Insertion

APPLICATION

- Switching power supply
- Free Wheel
- Home Appliances, Office Equipment
- Telecommunication, Factory Automation

OUTLINE DIMENSIONS

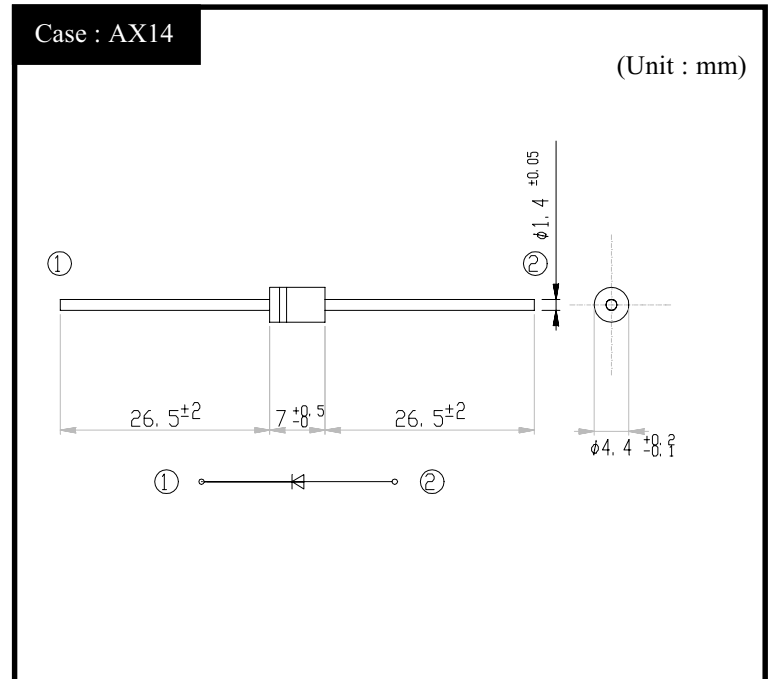

RATINGS

● Absolute Maximum Ratings (If not specified Tl=25°C)

Item	Symbol	Conditions	Ratings	Unit
Storage Temperature	T _{stg}		-40~150	°C
Operating Junction Temperature	T _j		150	°C
Maximum Reverse Voltage	V _{RM}		400	V
Average Rectified Forward Current	I _O	50Hz sine wave, R-load, Without heatsink Ta=25°C	1.8	A
		50Hz sine wave, R-load, Tl=123°C	3.0	
Peak Surge Forward Current	I _{FSM}	50Hz sine wave, Non-repetitive 1 cycle peak value, Tj=25°C	60	A

● Electrical Characteristics (If not specified Tl=25°C)

Item	Symbol	Conditions	Ratings	Unit
Forward Voltage	V _F	I _F =3.0A, Pulse measurement	Max.1.3	V
Reverse Current	I _R	V _R =V _{RM} , Pulse measurement	Max.10	μA
Reverse Recovery Time	trr	I _F =0.5A, I _R =1A	Max.50	ns
Thermal Resistance	θ _{jl}	junction to lead	Max.6.5	°C/W
	θ _{ja}	junction to ambient	Max.60	

S3L40

Forward Voltage

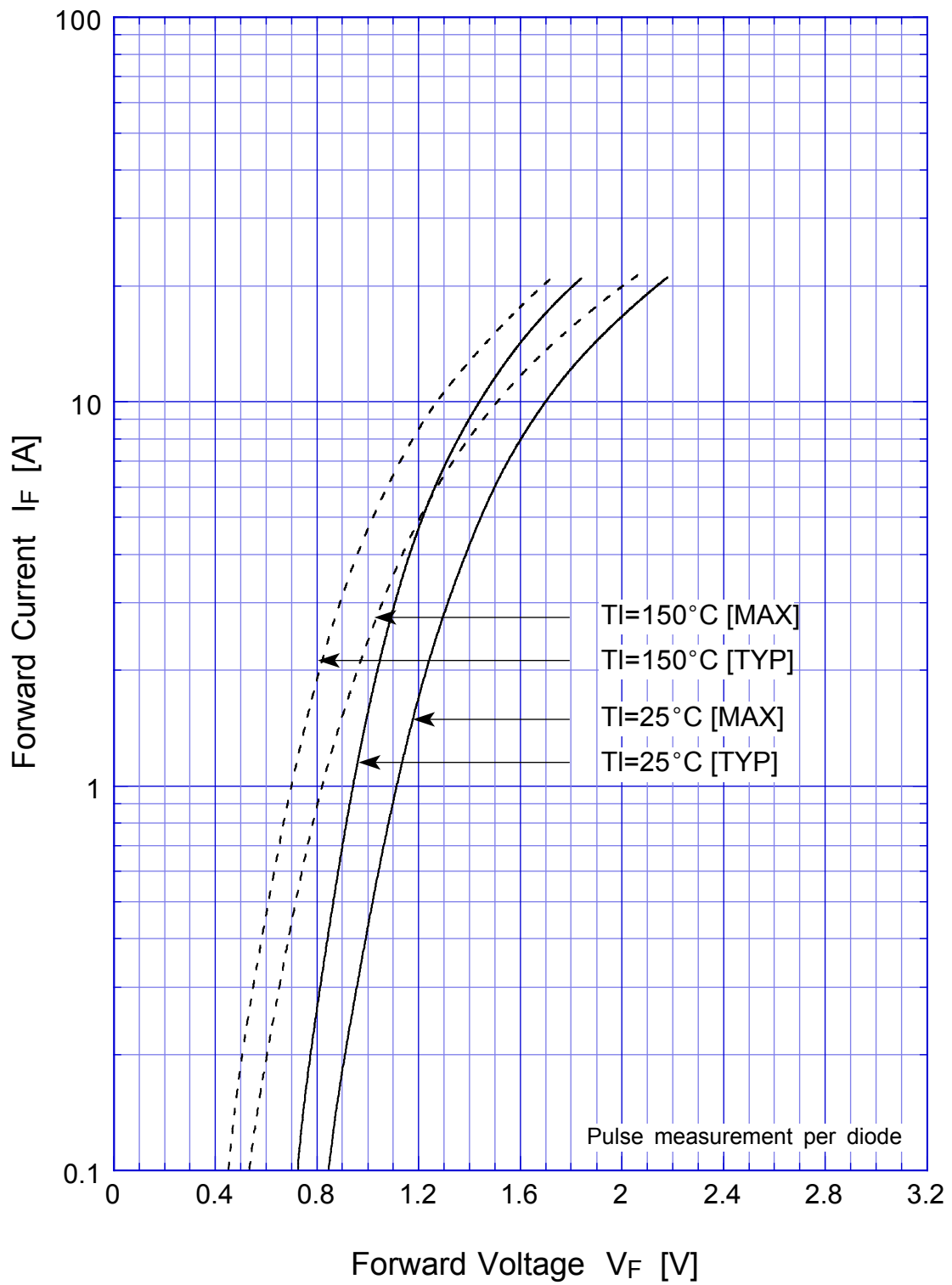

S3L40

Forward Power Dissipation

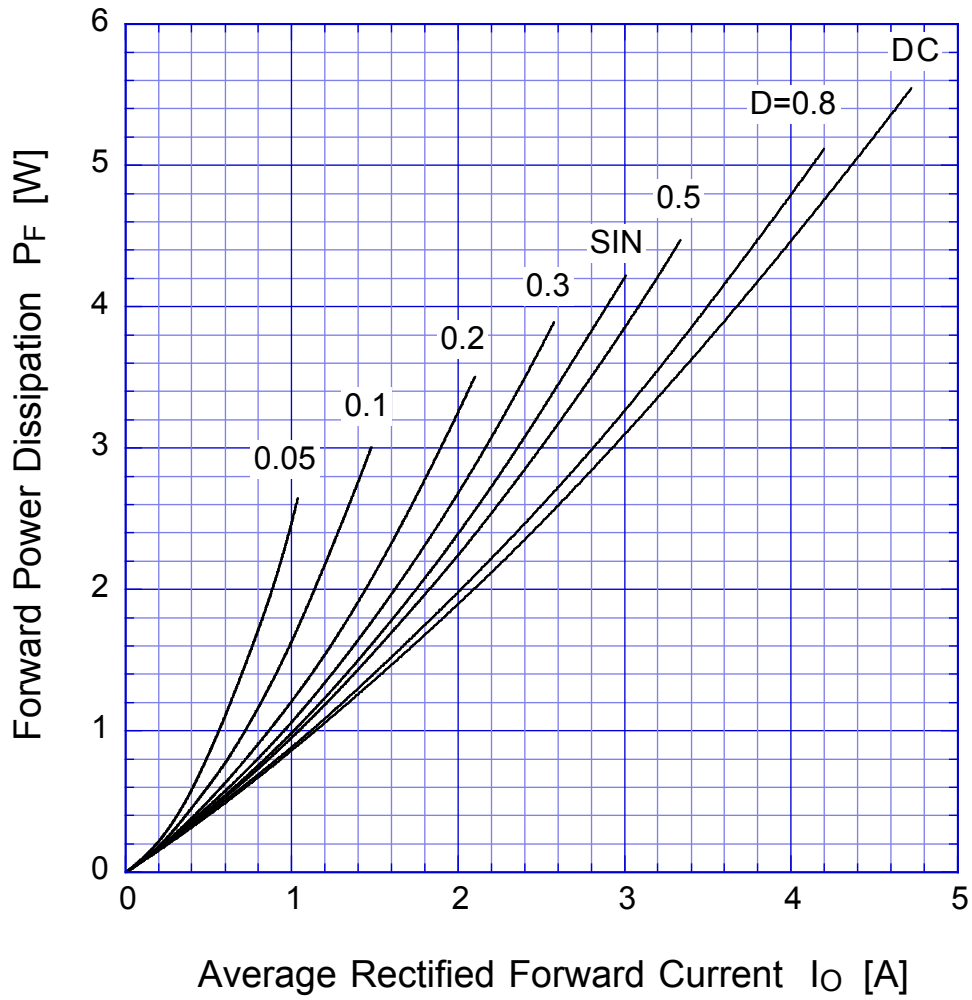

$T_j = T_{jmax}$

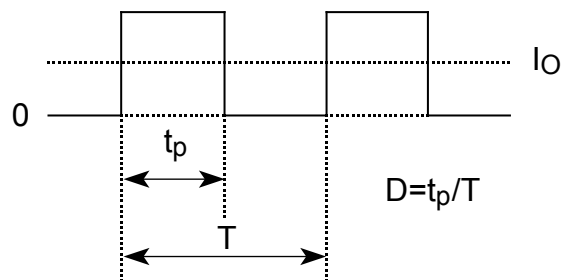

S3L40

Derating Curve

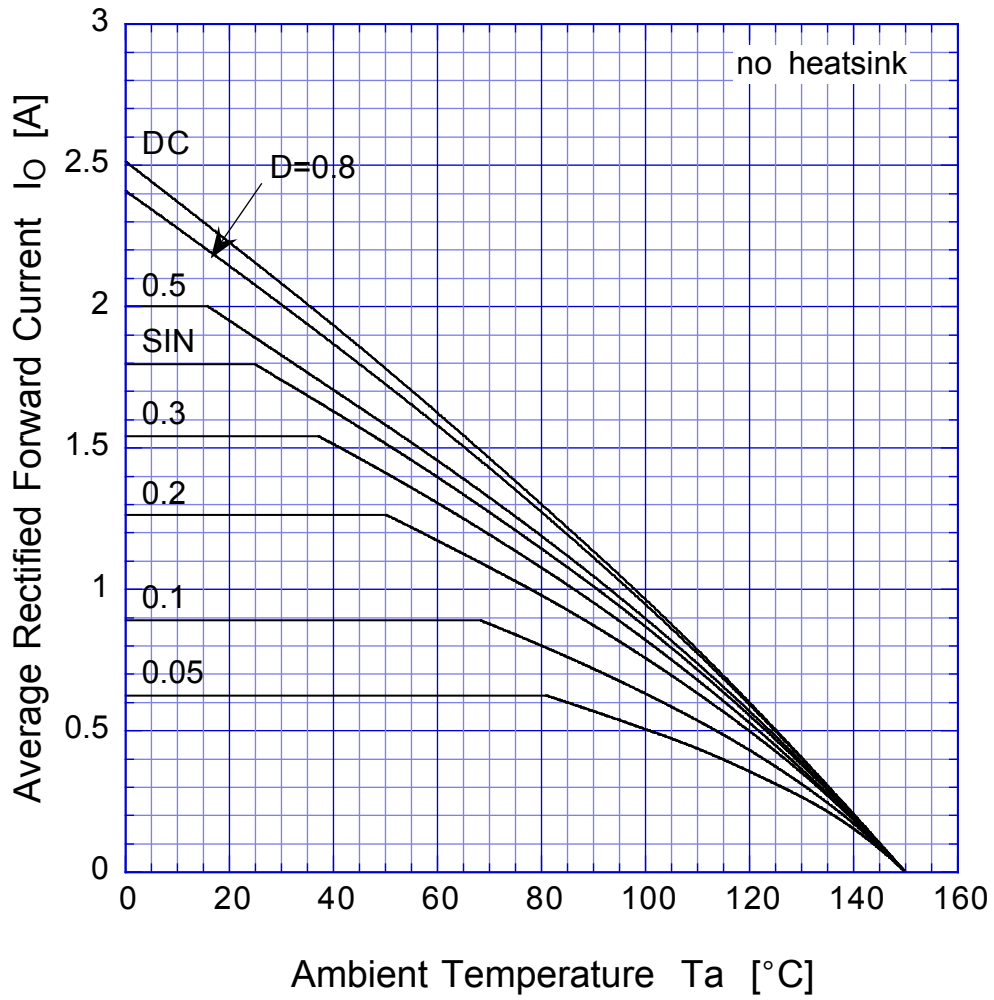

$$V_R = V_{RM}$$



S3L40

Derating Curve

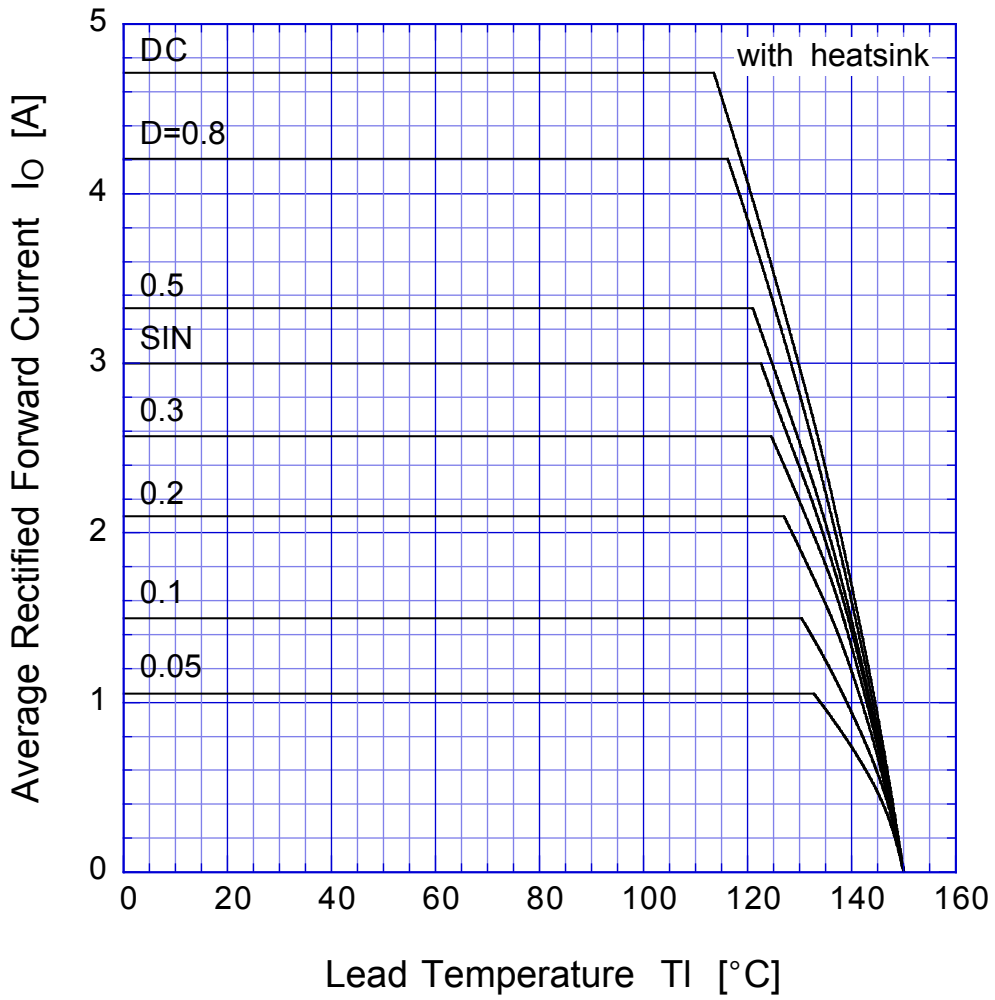

$$V_R = V_{RM}$$



S3L40

Peak Surge Forward Capability

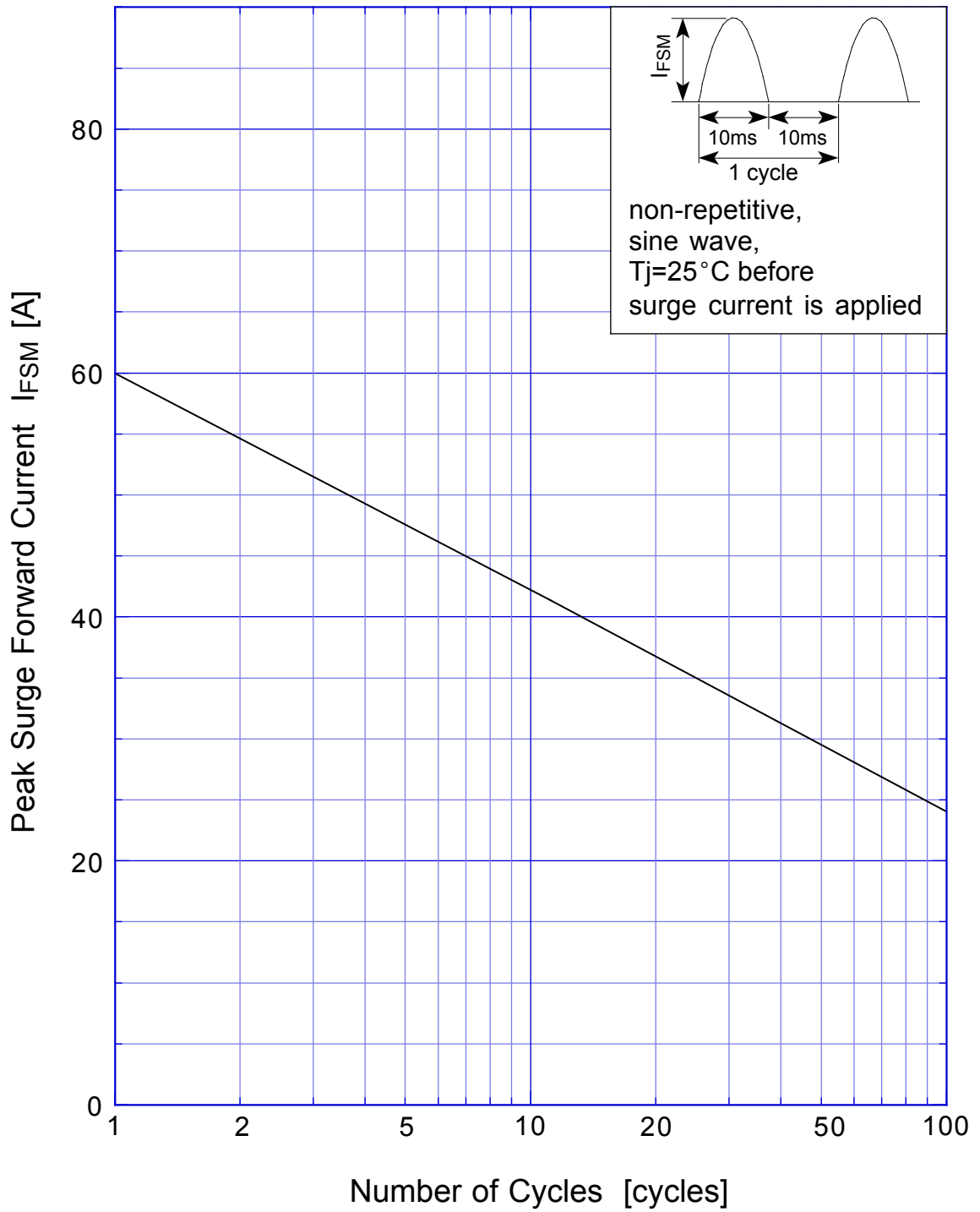

S3L40 Junction Capacitance

