

SHINDENGEN

Super Fast Recovery Rectifiers

Single

SF3L60U

600V 3A

OUTLINE DIMENSIONS

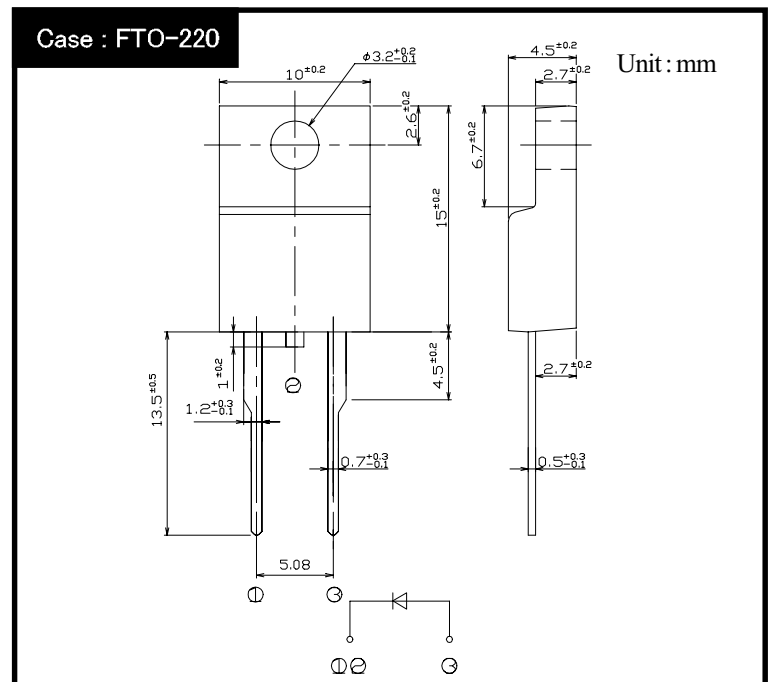

RATINGS

● Absolute Maximum Ratings (If not specified $T_c=25^\circ\text{C}$)

Item	Symbol	Conditions	Ratings	Unit
Storage Temperature	T_{stg}		-55~150	$^\circ\text{C}$
Operating Junction Temperature	T_j		150	$^\circ\text{C}$
Max Reverse Voltage	V_{RM}		600	V
Average Rectified Forward Current	I_o	50Hz sine wave, resistance load, $T_c=115^\circ\text{C}$	3	A
Peak Surge Forward Current	I_{FSM}	50Hz sine wave, Non-repetitive 1 cycle peak value, $T_j=25^\circ\text{C}$	40	A
Dielectric Strength	V_{dis}	Terminals to case, AC 1 minute	2	kV
Mounting Torque	TOR	() Shows recommended value	0.5(0.3)	N·m

● Electrical Characteristics (If not specified $T_c=25^\circ\text{C}$)

Item	Symbol	Conditions	Ratings	Unit
Forward Voltage	V_F	$I_F=3\text{A}$, Pulse measurement	Max.3.0	V
Reverse Current	I_R	$V_R=V_{RM}$, Pulse measurement	Max.25	μA
Junction Capacitance	C_j	$f=1\text{MHz}$, $V_R=10\text{V}$	Typ.20	pF
Reverse Recovery Time	t_{rr}	$I_F=0.5\text{A}$, $I_R=1\text{A}$	Max.20	ns
Thermal Resistance	θ_{jc}	junction to case with heatsink	Max.3.8	$^\circ\text{C/W}$

SF3L60U

Forward Voltage

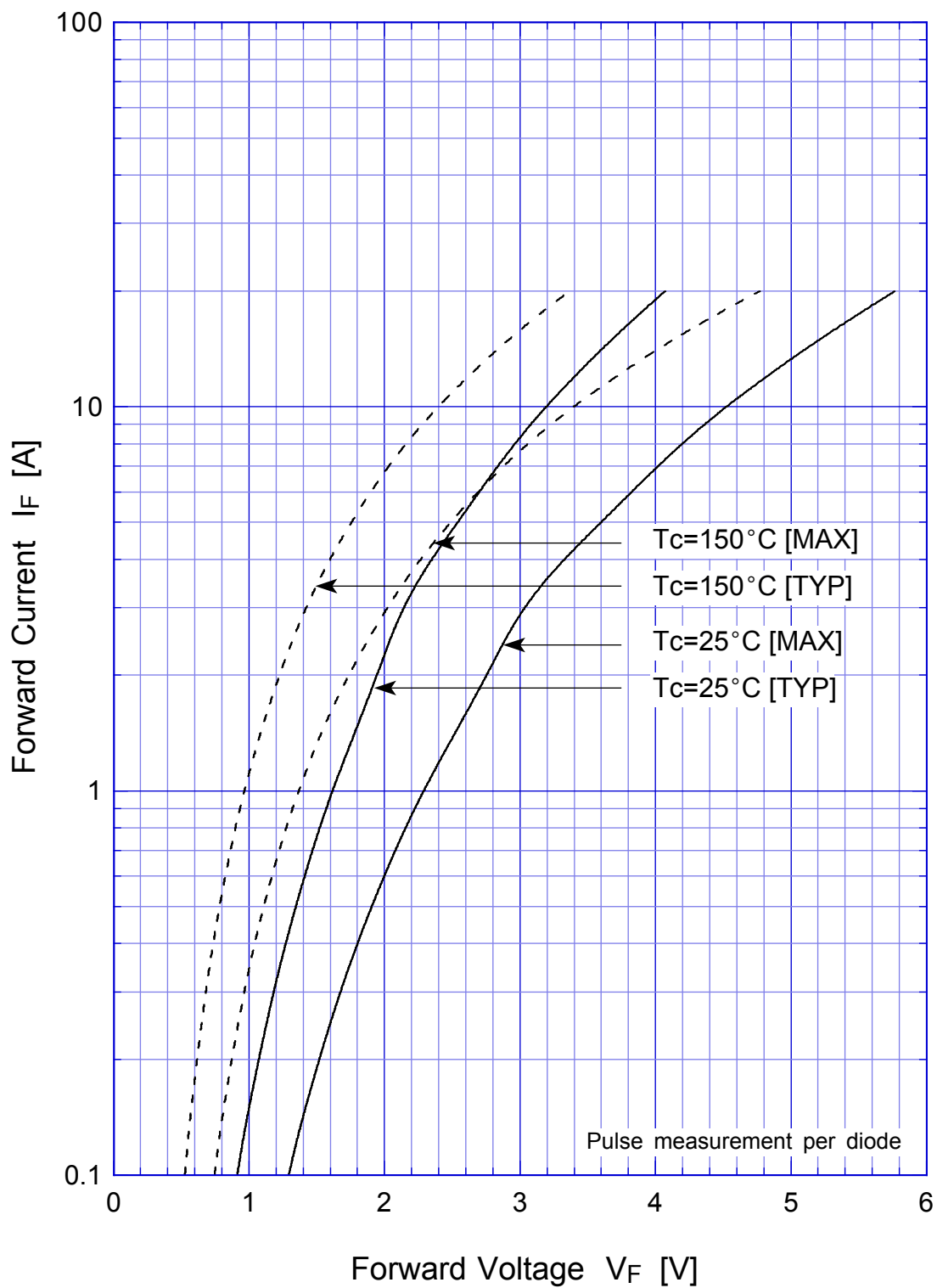

SF3L60U Forward Power Dissipation

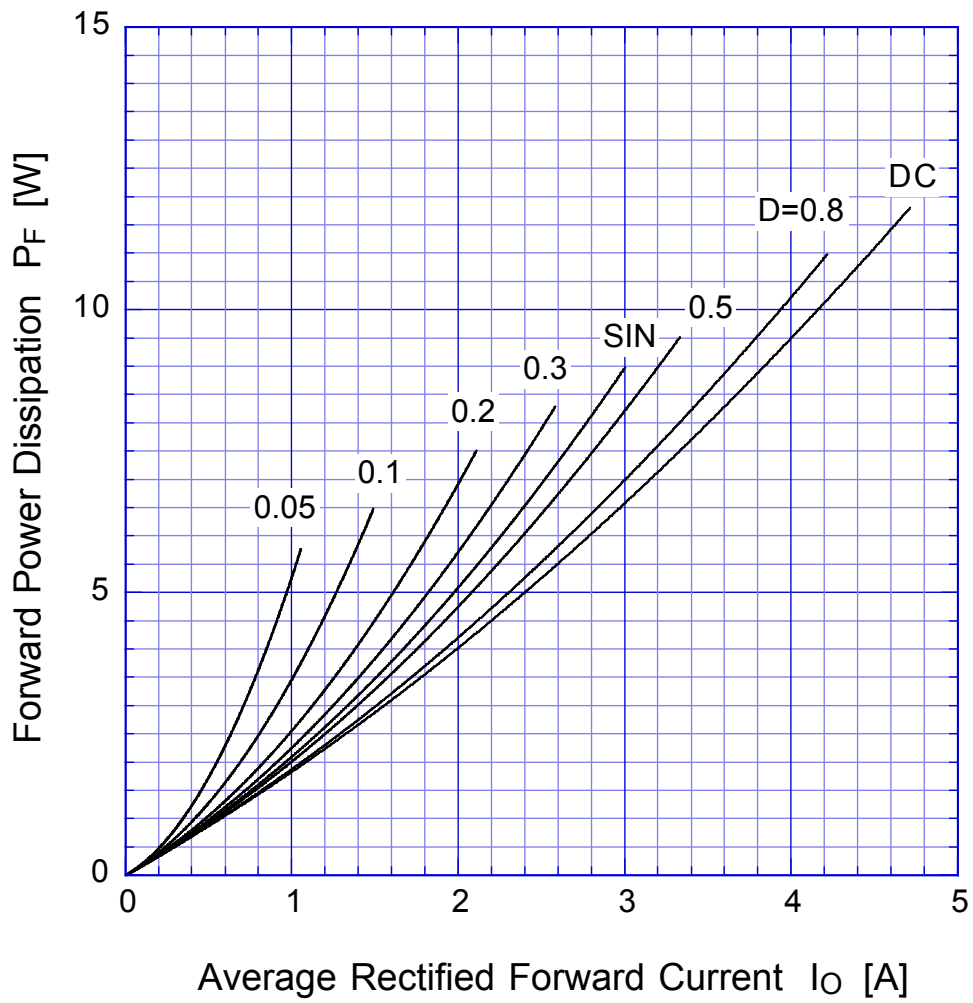

$T_j = 150^\circ\text{C}$

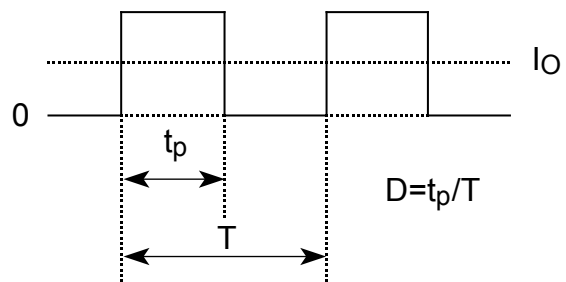

SF3L60U

Derating Curve

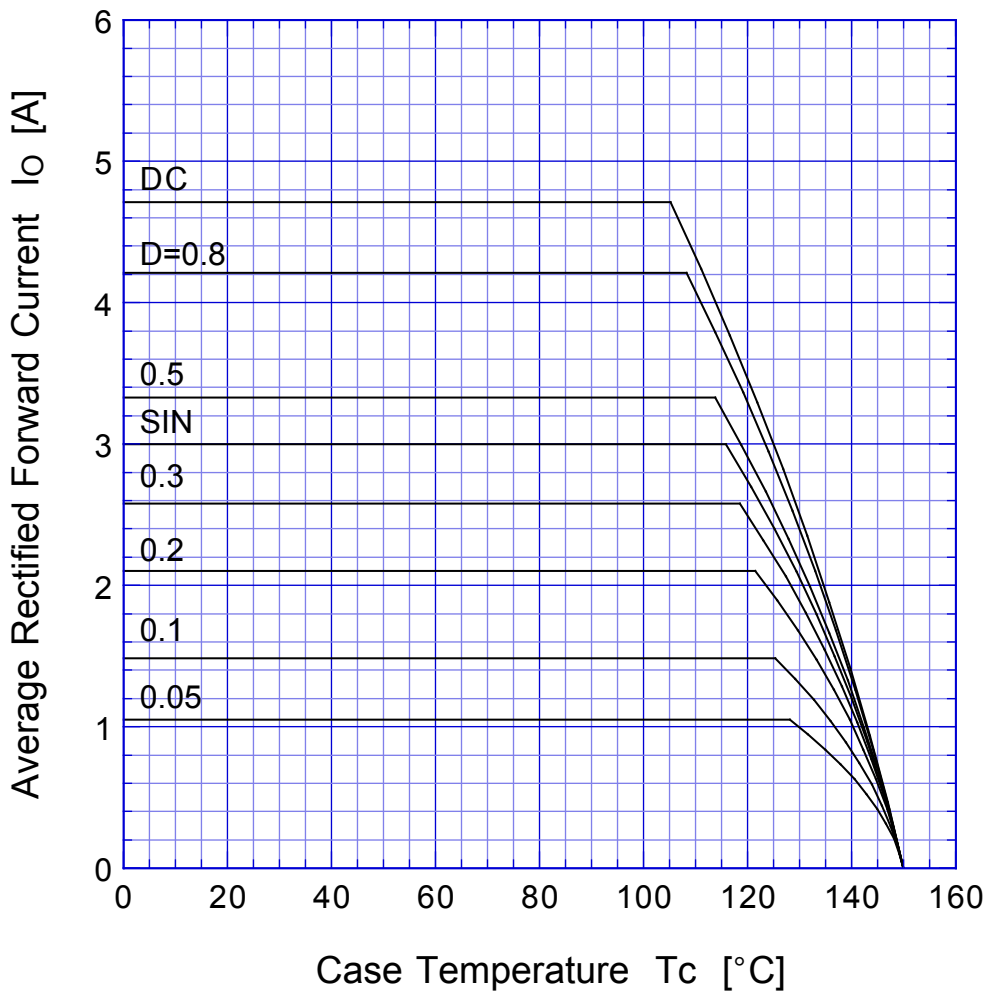

$$V_R = V_{RM}$$

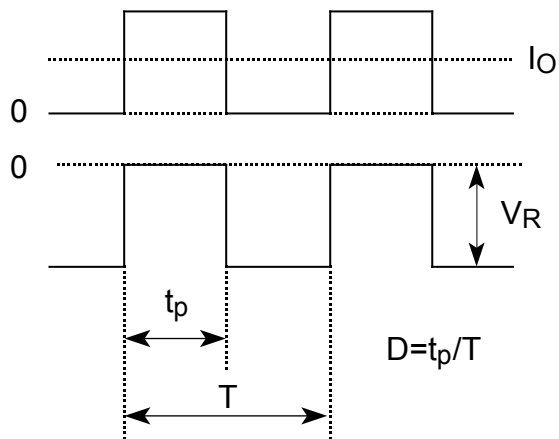

SF3L60U

Peak Surge Forward Capability

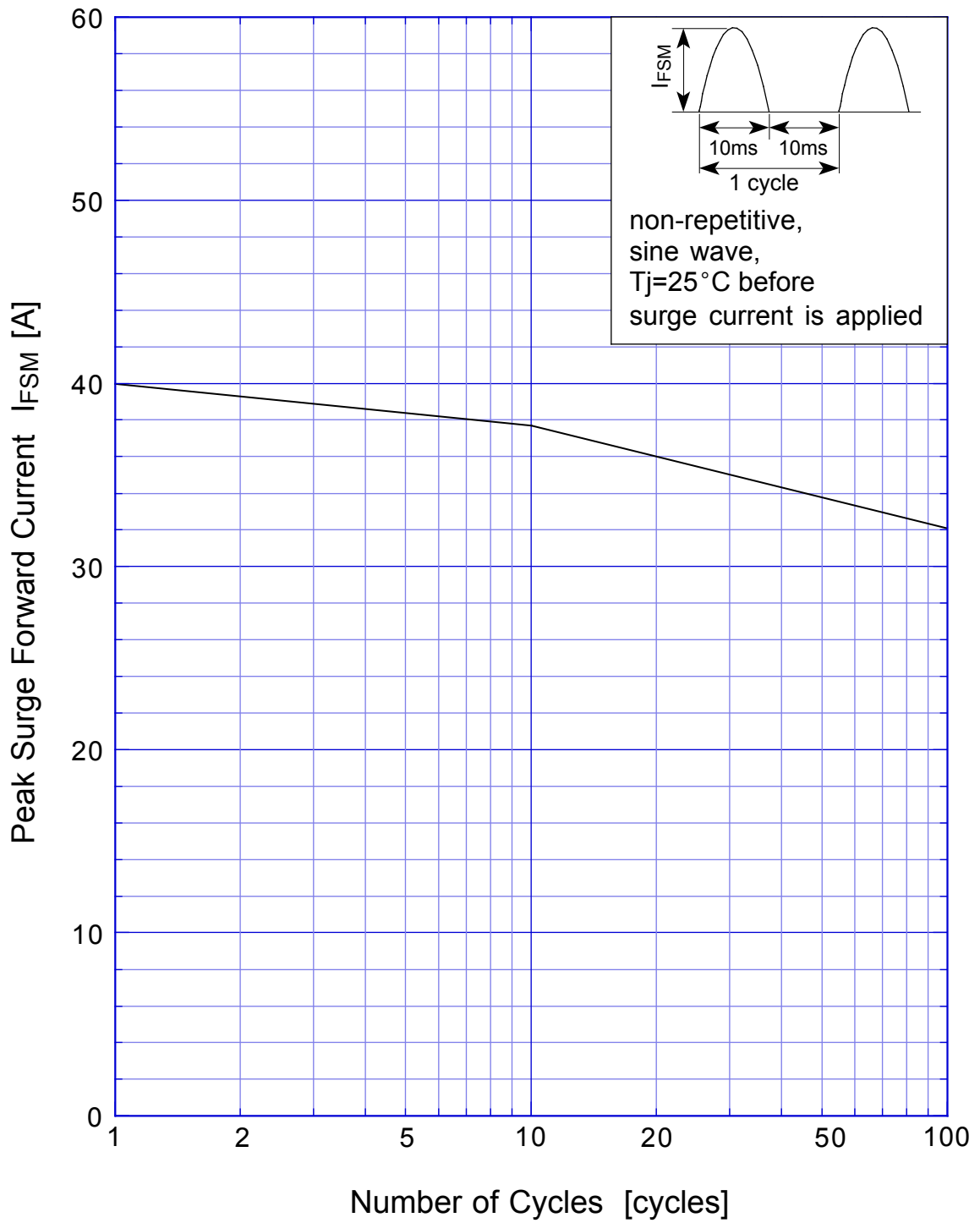

SF3L60U Junction Capacitance

