

High Voltage Full Bridge Drive IC SLA2402M

Features

- One Package Full Bridge Driver Consisted of High Voltage IC and Power MOS FETs (4 pieces)
- High Voltage Driver which accepts direct connection to the input signal line
- External components such as high voltage diodes and capacitors are not required

Absolute Maximum Ratings

Parameter	Symbol	Ratings	Unit	Conditions
Power source voltage *	V_M	500	V	
Input voltage	V_{IN}	15	V	
Output voltage	V_O	500	V	
Output current	I_O	15	A	$P_W \leq 250\mu s$
Power dissipation	P_D	5 ($T_a=25^\circ C$)	W	Without heatsink
Storage temperature	T_{stg}	-40 to +125	$^\circ C$	
Operation temperature	T_{opr}	-40 to +105	$^\circ C$	

* Power GND (D terminal) to -HV (-HV terminal) voltage.

Electrical Characteristics

Parameter	Symbol	Ratings			Unit	Conditions
		min	typ	max		
Power MOS FET output breakdown voltage	BV_{OUT}	500			V	$I_O=100\mu A$
Power MOS FET output leakage voltage	$I_{OUT(off)}$			100	μA	$V_O=500V$
High-side Power MOS FET output on-state voltage	$V_{OUT(on)1}$	0.28	0.4	0.52	V	$I_O=0.4A, V_{IN}=10V$
	$V_{OUT(on)2}$	1.4	2.0	2.6	V	$I_O=2A, V_{IN}=10V$
Low-side Power MOS FET output on-state voltage	$V_{OUT(on)1}$	0.28	0.4	0.52	V	$I_O=0.4A, V_{GL}=10V$
	$V_{OUT(on)2}$	1.4	2.0	2.6	V	$I_O=2A, V_{GL}=10V$
Quiescent circuit current	I_{CC1}			3.0	mA	$V_{CC}=4.5$ to $15V$
	I_{CC2}			4.0	mA	$V_{CC}=10V, V_M=400V$
Operating circuit current	I_{CC3}			4.0	mA	$V_{CC}=10V, V_M=400V$
Input voltage (High level)	V_{IH}	$0.8V_{CC}$			V	$V_{CC}=4.5$ to $15V$
Input voltage (Low level)	V_{IL}			$0.2V_{CC}$	V	$V_{CC}=4.5$ to $15V$
Delay time *	$t_d(on)$		1.4		μs	$V_{CC}=10A, V_{IN}=10V,$ $V_M=85A,$ $I_O=0.41A$
	$t_d(off)$		3.3		μs	
	Δt			2.5		μs
Operating voltage	V_{CC}			15	V	-40 to +105 $^\circ C$

* About delay time

Signal input waveform vs output waveform

① Highside switch turn-on, turn-off

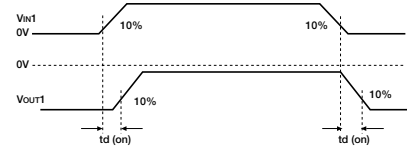

② Lowside switch turn-on, turn-off

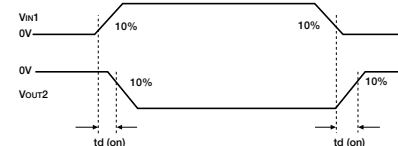

* $\Delta t: \Delta t = t_d(on) - t_d(off)$

Measurement Circuit

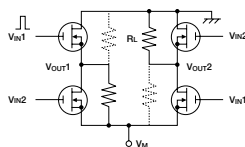

Conditions

$V_{CC}=10V, V_{IN}=10V$ (pulse)

$V_M=85V$

$I_O=0.41A$ ($R_L=207\Omega$)

* When pulse signal is inputted to V_{IN1} , R_L on solid line is ON and dotted line is off.

On the contrary, when pulse signal is inputted to V_{IN2} , R_L on dotted line is ON and solid line is off.

External Dimensions (unit: mm)

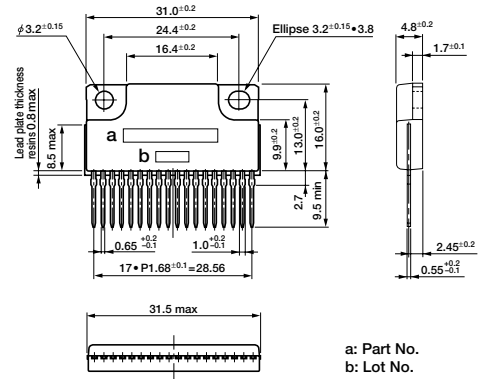

a: Part No.
b: Lot No.

Block Diagram

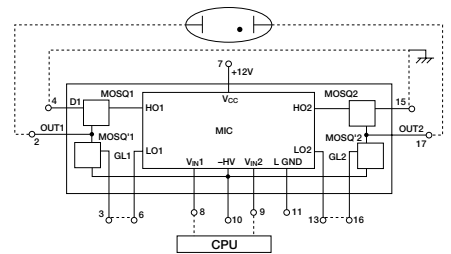

* Dotted Line: Outside Connection

Timing Chart

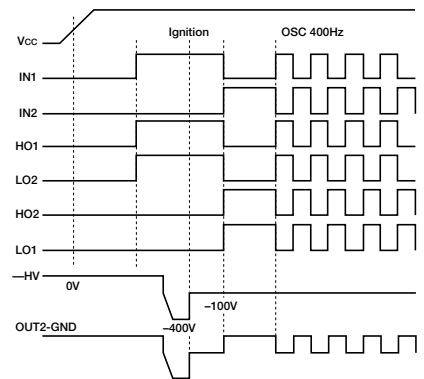

Electrical Characteristics

■ Quiescent circuit current

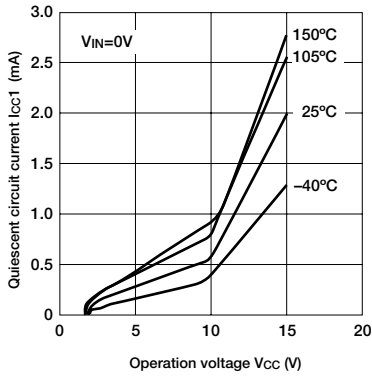

■ Quiescent circuit current supplied high voltage

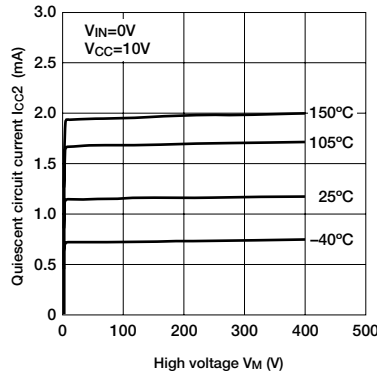

■ Operating circuit current

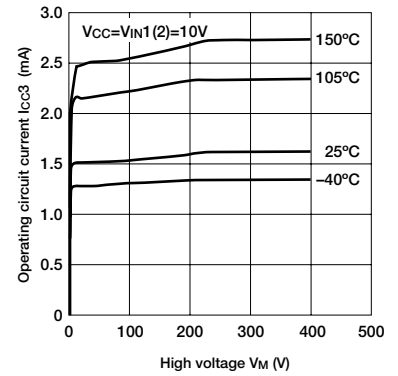

■ Quiescent circuit current supplied high voltage

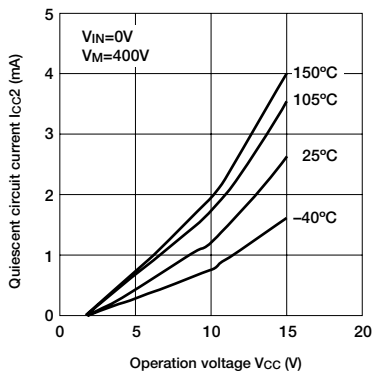

■ Quiescent circuit current

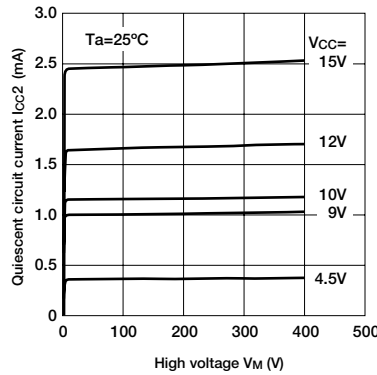

■ Operating circuit current

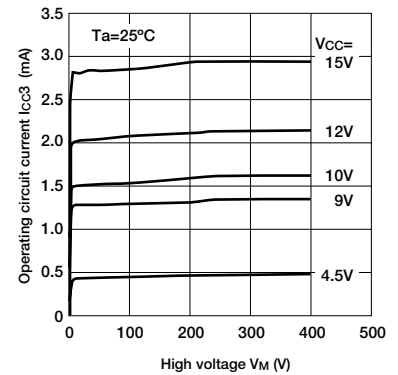

■ Output on-state voltage

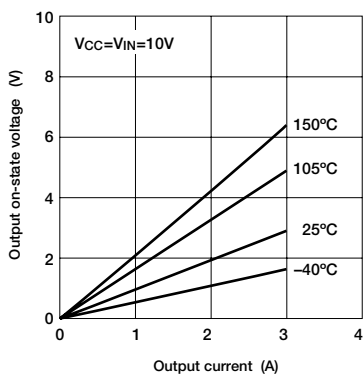

■ Gate drive voltage

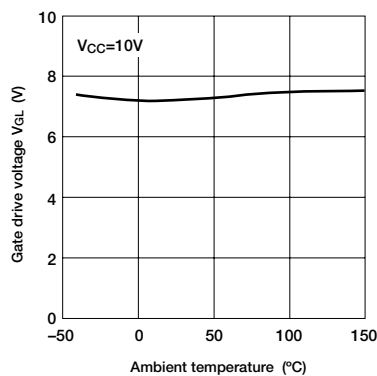

■ Gate drive voltage

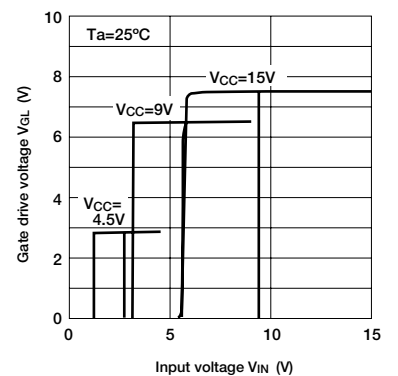

■ Output on-state voltage

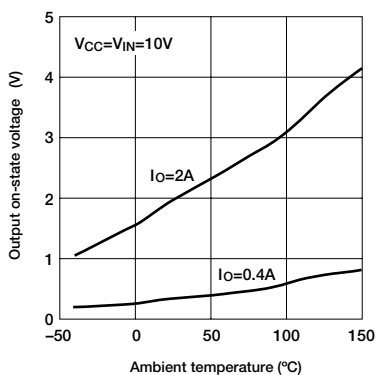

■ Input threshold voltage

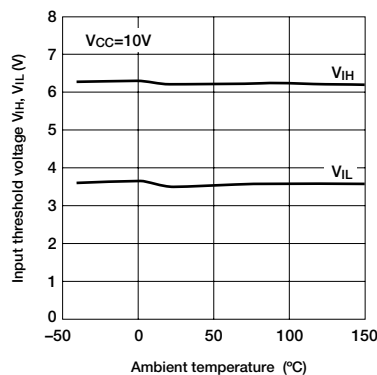

Electrical Characteristics

High side switch turn-on, off

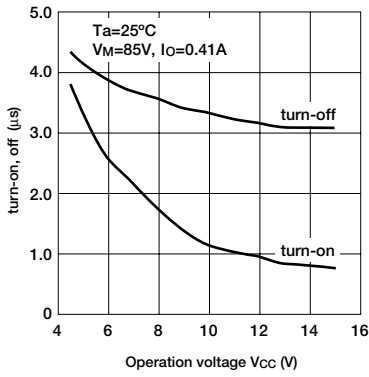

High side switch turn-on, off

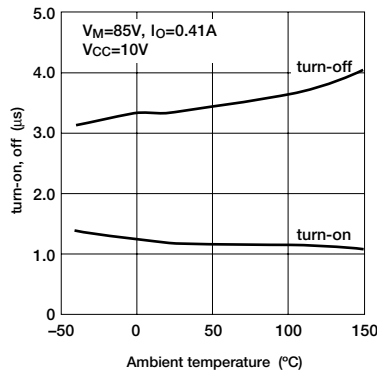

Low side switch turn-on, off

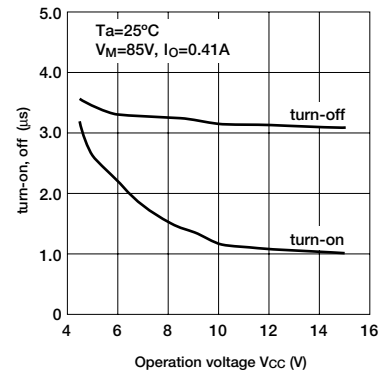

Low side switch turn-on, off

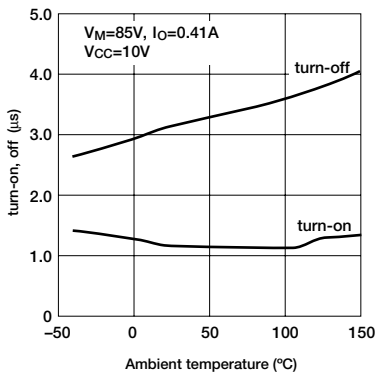

Transient thermal resistance characteristics

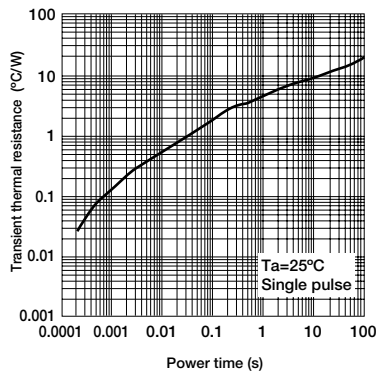

Safe operating area (Power MOS FET)

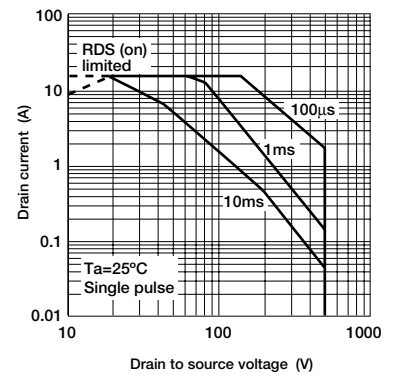

Power derating curve

