

TA78DM05S, TA78DM08S, TA78DM09S, TA78DM12S

5 V, 8 V, 9 V, 12 V

LOW DROPOUT VOLTAGE REGULATOR

The TA78DMxxS series consists of positive fixed output voltage regulator IC capable of sourcing current up to 500mA.

Due to the features of low dropout voltage and low standby current, these devices are useful for battery powered equipment.

FEATURES

- Low Standby Current of 800 μ A Typical.
- Maximum Output Current Up to 500 mA.
- Low Dropout Voltage of Less than 0.75 V ($I_O = 0.5$ A).
- Multi-protection : Reverse Connection of Power Supply, 60V Load Dump, Thermal Shut Down and Current Limiting.
- Metal Fin (Tab) is Fully Covered with Mold Resin. (TO-220 NIS package)

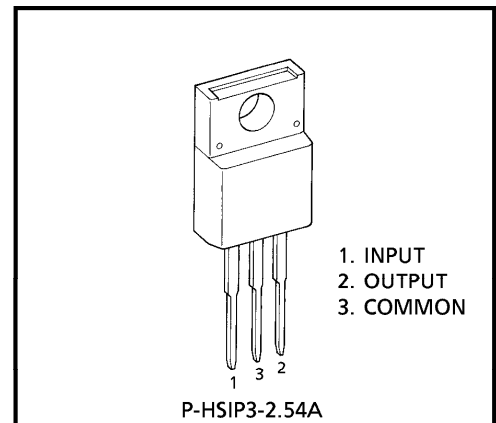

Weight : 1.7 g (Typ.)

BLOCK DIAGRAM

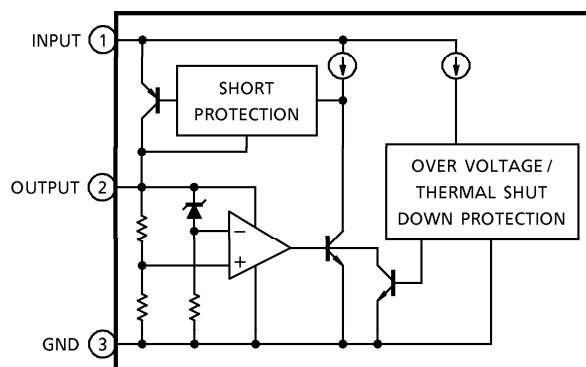

980910EBA1

- TOSHIBA is continually working to improve the quality and the reliability of its products. Nevertheless, semiconductor devices in general can malfunction or fail due to their inherent electrical sensitivity and vulnerability to physical stress. It is the responsibility of the buyer, when utilizing TOSHIBA products, to observe standards of safety, and to avoid situations in which a malfunction or failure of a TOSHIBA product could cause loss of human life, bodily injury or damage to property. In developing your designs, please ensure that TOSHIBA products are used within specified operating ranges as set forth in the most recent products specifications. Also, please keep in mind the precautions and conditions set forth in the TOSHIBA Semiconductor Reliability Handbook.
- The products described in this document are subject to the foreign exchange and foreign trade laws.
- The information contained herein is presented only as a guide for the applications of our products. No responsibility is assumed by TOSHIBA CORPORATION for any infringements of intellectual property or other rights of the third parties which may result from its use. No license is granted by implication or otherwise under any intellectual property or other rights of TOSHIBA CORPORATION or others.
- The information contained herein is subject to change without notice.

MAXIMUM RATINGS (Ta = 25°C)

CHARACTERISTIC	SYMBOL	RATING	UNIT
Operating Input Voltage	V _{IN}	29	V
Input Voltage of Surge	V _{IN}	60	V
Power Dissipation	(Ta = 25°C)	2	W
	(Tc = 25°C)	20	
Operating Temperature	T _{opr}	-40~85	°C
Storage Temperature	T _{stg}	-55~150	°C
Thermal Resistance	R _{th(j-c)}	6.25	°C/W
	R _{th(j-a)}	62.5	
Storage Temperature·Time	T _{sol}	260 (10 s)	°C

TA78DM05S

ELECTRICAL CHARACTERISTICS

(Unless otherwise specified, V_{IN} = 14 V, I_{OUT} = 250 mA, T_j = 25°C, C_{IN} = 0.1 μF, C_{OUT} = 100 μF)

CHARACTERISTIC	SYMBOL	TEST CIR-CUIT	TEST CONDITION	MIN.	TYP.	MAX.	UNIT
Output Voltage	V _{OUT}	—	—	4.75	5	5.25	V
			6 V ≤ V _{IN} ≤ 26 V, 5 mA ≤ I _{OUT} ≤ 250 mA	4.7	—	5.3	
Line Regulation	Reg·line	—	6 V ≤ V _{IN} ≤ 26 V	—	3	30	mV
Load Regulation	Reg·load	—	V _{IN} = 6 V, 5 mA ≤ I _{OUT} ≤ 500 mA	—	66	240	mV
			V _{IN} = 26 V, 5 mA ≤ I _{OUT} ≤ 500 mA	—	40	240	
Quiescent Current	I _B	—	6 V ≤ V _{IN} ≤ 26 V, I _{OUT} = 0 mA	—	0.8	1.4	mA
			6 V ≤ V _{IN} ≤ 26 V, I _{OUT} = 250 mA	—	14	27	
Dropout Voltage	V _D	—	I _{OUT} = 250 mA	—	0.2	0.35	V
			I _{OUT} = 500 mA	—	0.4	0.75	
Short Circuit Current Limit	I _{SC}	—	—	—	0.7	—	A

TA78DM08S

ELECTRICAL CHARACTERISTICS

(Unless otherwise specified, V_{IN} = 16 V, I_{OUT} = 250 mA, T_j = 25°C, C_{IN} = 0.1 μF, C_{OUT} = 100 μF)

CHARACTERISTIC	SYMBOL	TEST CIR-CUIT	TEST CONDITION	MIN.	TYP.	MAX.	UNIT
Output Voltage	V _{OUT}	—	—	7.6	8	8.4	V
			9 V ≤ V _{IN} ≤ 26 V, 5 mA ≤ I _{OUT} ≤ 250 mA	7.52	—	8.48	
Line Regulation	Reg·line	—	9 V ≤ V _{IN} ≤ 26 V	—	6	48	mV
Load Regulation	Reg·load	—	V _{IN} = 9 V, 5 mA ≤ I _{OUT} ≤ 500 mA	—	54	380	mV
			V _{IN} = 26 V, 5 mA ≤ I _{OUT} ≤ 500 mA	—	47	380	
Quiescent Current	I _B	—	9 V ≤ V _{IN} ≤ 26 V, I _{OUT} = 0 mA	—	0.9	1.5	mA
			9 V ≤ V _{IN} ≤ 26 V, I _{OUT} = 250 mA	—	16	27	
Dropout Voltage	V _D	—	I _{OUT} = 250 mA	—	0.2	0.35	V
			I _{OUT} = 500 mA	—	0.4	0.75	
Short Circuit Current Limit	I _{SC}	—	—	—	0.7	—	A

TA78DM09S

ELECTRICAL CHARACTERISTICS

(Unless otherwise specified, $V_{IN} = 16\text{ V}$, $I_{OUT} = 250\text{ mA}$, $T_j = 25^\circ\text{C}$, $C_{IN} = 0.1\ \mu\text{F}$, $C_{OUT} = 100\ \mu\text{F}$)

CHARACTERISTIC	SYMBOL	TEST CIR-CUIT	TEST CONDITION	MIN.	TYP.	MAX.	UNIT
Output Voltage	V_{OUT}	—	—	8.55	9	9.45	V
			$10\text{ V} \leq V_{IN} \leq 26\text{ V}$, $5\text{ mA} \leq I_{OUT} \leq 250\text{ mA}$	8.46	—	9.54	
Line Regulation	Reg·line	—	$10\text{ V} \leq V_{IN} \leq 26\text{ V}$	—	9	54	mV
Load Regulation	Reg·load	—	$V_{IN} = 10\text{ V}$, $5\text{ mA} \leq I_{OUT} \leq 500\text{ mA}$	—	47	430	mV
			$V_{IN} = 26\text{ V}$, $5\text{ mA} \leq I_{OUT} \leq 500\text{ mA}$	—	50	430	
Quiescent Current	I_B	—	$10\text{ V} \leq V_{IN} \leq 26\text{ V}$, $I_{OUT} = 0\text{ mA}$	—	0.9	1.6	mA
			$10\text{ V} \leq V_{IN} \leq 26\text{ V}$, $I_{OUT} = 250\text{ mA}$	—	16	27	
Dropout Voltage	V_D	—	$I_{OUT} = 250\text{ mA}$	—	0.2	0.35	V
			$I_{OUT} = 500\text{ mA}$	—	0.4	0.75	
Short Circuit Current Limit	I_{SC}	—	—	—	0.7	—	A

TA78DM12S

ELECTRICAL CHARACTERISTICS

(Unless otherwise specified, $V_{IN} = 18\text{ V}$, $I_{OUT} = 250\text{ mA}$, $T_j = 25^\circ\text{C}$, $C_{IN} = 0.1\ \mu\text{F}$, $C_{OUT} = 100\ \mu\text{F}$)

CHARACTERISTIC	SYMBOL	TEST CIR-CUIT	TEST CONDITION	MIN.	TYP.	MAX.	UNIT
Output Voltage	V_{OUT}	—	—	11.4	12	12.6	V
			$13\text{ V} \leq V_{IN} \leq 26\text{ V}$, $5\text{ mA} \leq I_{OUT} \leq 250\text{ mA}$	11.28	—	12.72	
Line Regulation	Reg·line	—	$13\text{ V} \leq V_{IN} \leq 26\text{ V}$	—	10	72	mV
Load Regulation	Reg·load	—	$V_{IN} = 13\text{ V}$, $5\text{ mA} \leq I_{OUT} \leq 500\text{ mA}$	—	84	580	mV
			$V_{IN} = 26\text{ V}$, $5\text{ mA} \leq I_{OUT} \leq 500\text{ mA}$	—	45	580	
Quiescent Current	I_B	—	$13\text{ V} \leq V_{IN} \leq 26\text{ V}$, $I_{OUT} = 0\text{ mA}$	—	1.0	1.7	mA
			$13\text{ V} \leq V_{IN} \leq 26\text{ V}$, $I_{OUT} = 250\text{ mA}$	—	16	27	
Dropout Voltage	V_D	—	$I_{OUT} = 250\text{ mA}$	—	0.2	0.35	V
			$I_{OUT} = 500\text{ mA}$	—	0.4	0.75	
Short Circuit Current Limit	I_{SC}	—	—	—	0.7	—	A

APPLICATION CIRCUITS

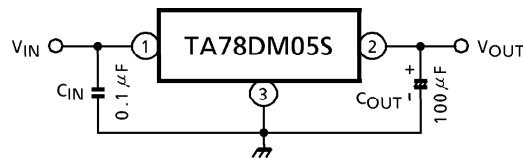

Capacitor C_2 must be guaranteed to operate of the temperature range that the regulator should be operated correctly.

100 μF is a suitable value to suppress the oscillation phenomenon at the output terminal.

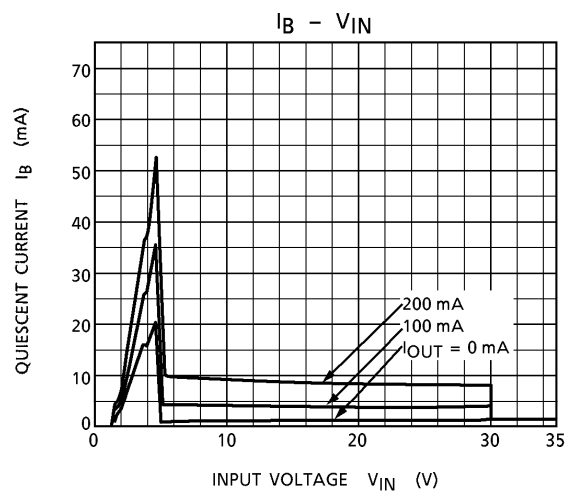
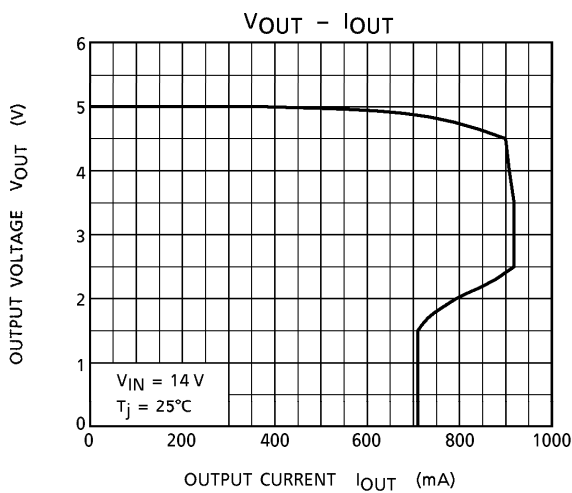
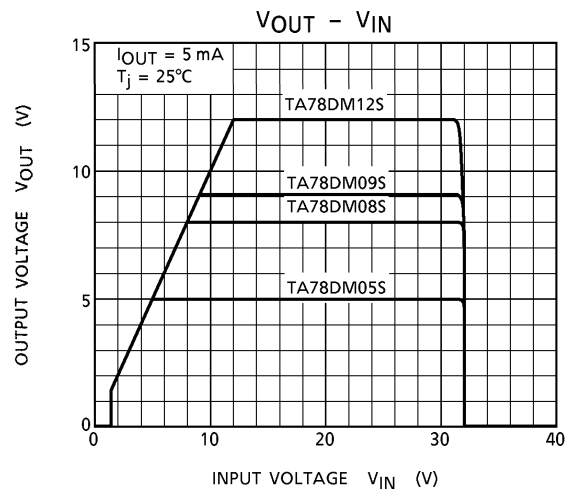
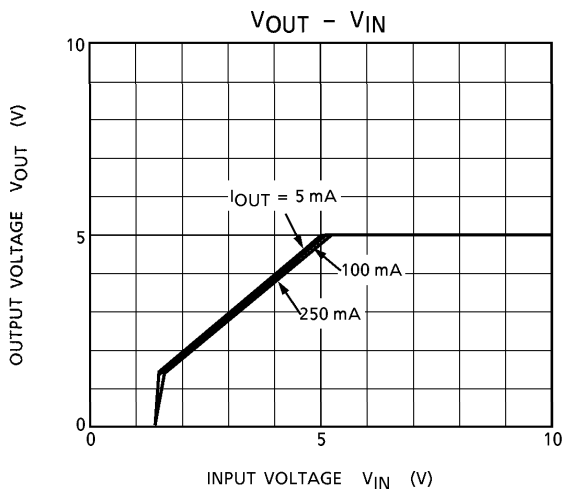
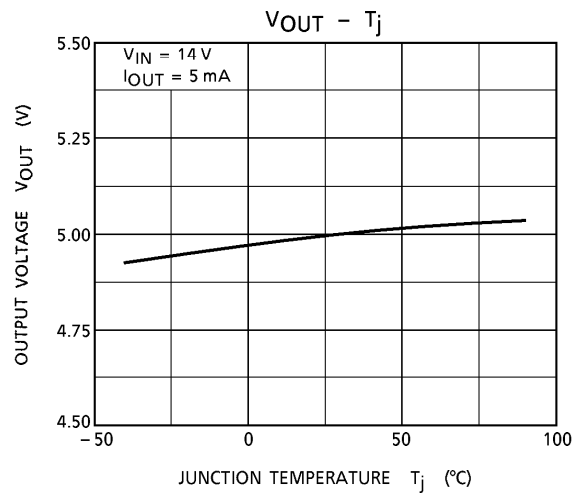
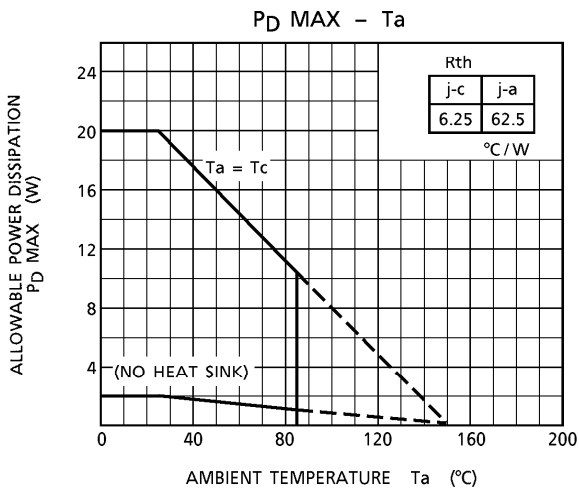

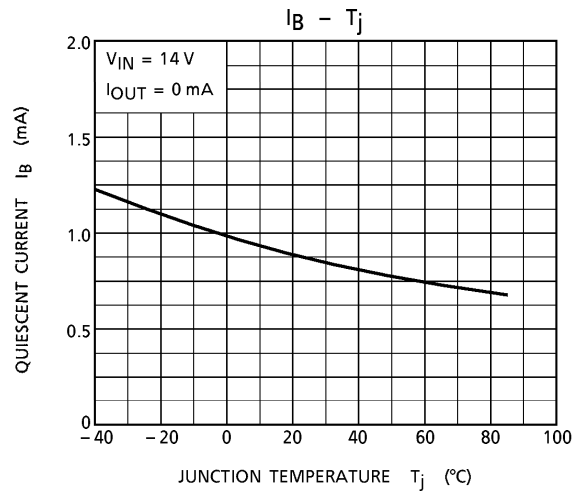
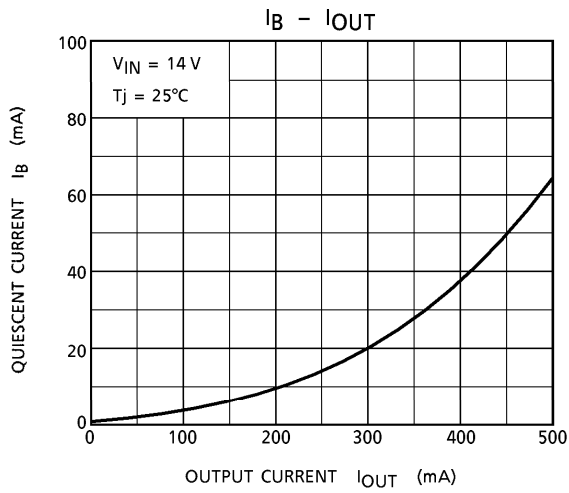
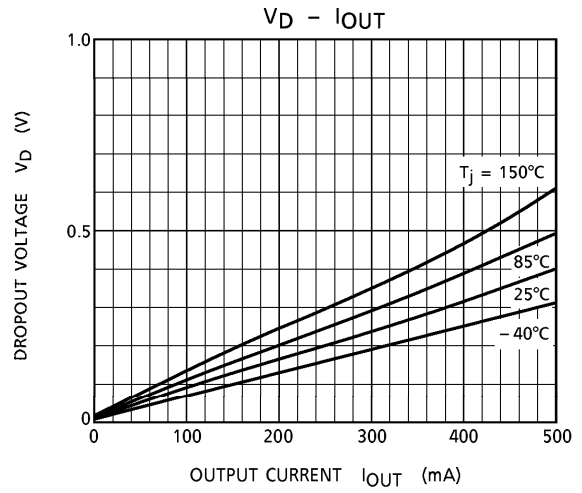
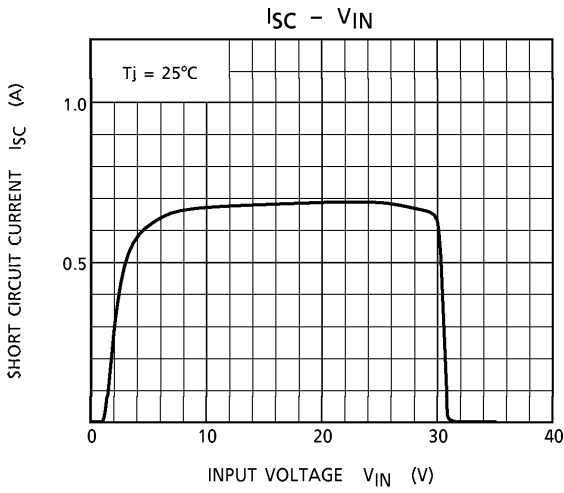

PACKAGE DIMENSIONS
P-HSIP3-2.54A

Unit : mm

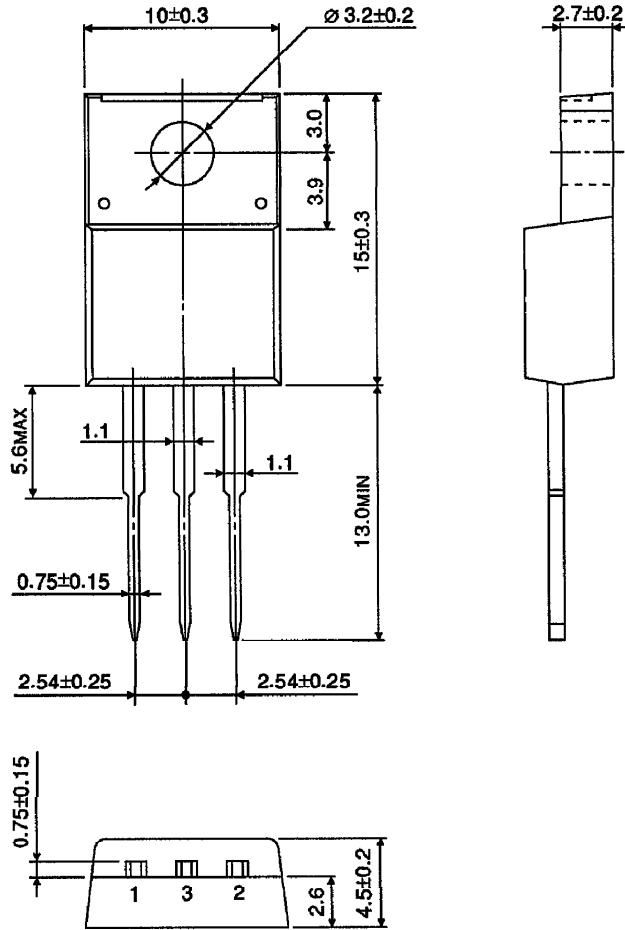

Weight : 1.7 g (Typ.)