

TL080 THRU TL085, TL080A THRU TL084A TL081B, TL082B, TL084B JFET-INPUT OPERATIONAL AMPLIFIERS

D2297, FEBRUARY 1977—REVISED NOVEMBER 1988

24 DEVICES COVER MILITARY, INDUSTRIAL AND COMMERCIAL TEMPERATURE RANGES

- Low-Power Consumption
- Wide Common-Mode and Differential Voltage Ranges
- Low Input Bias and Offset Currents
- Output Short-Circuit Protection
- Low Total Harmonic Distortion . . . 0.003% Typ
- High Input Impedance . . . JFET-Input Stage
- Internal Frequency Compensation (Except TL080, TL080A)
- Latch-Up-Free Operation
- High Slew Rate . . . 13 V/ μ s Typ
- Common-Mode Input Voltage Range Includes V_{CC+}

TL080, TL080A
D, JG, OR P PACKAGE

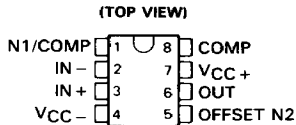

TL081, TL081A, TL081B
D, JG, OR P PACKAGE

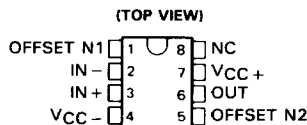

TL082, TL082A, TL082B
D, JG, OR P PACKAGE

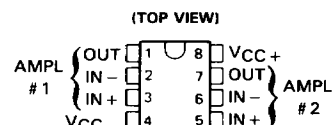

TL081M . . . FK CHIP CARRIER PACKAGE

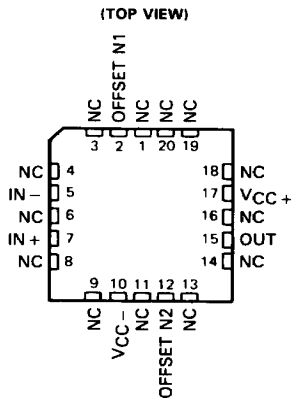

TL082M . . . FK CHIP CARRIER PACKAGE

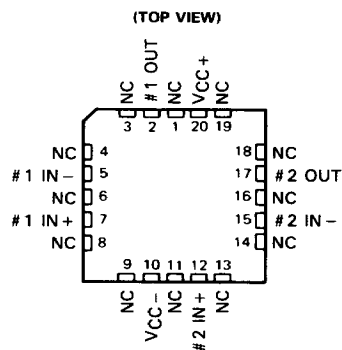

TL083, TL083A
D, J, OR N PACKAGE

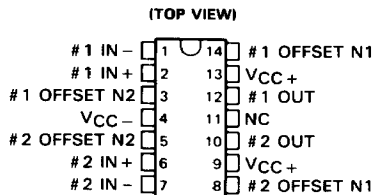

Pins 9 and 13 are internally interconnected

TL084, TL084A, TL084B
D, J, OR N PACKAGE

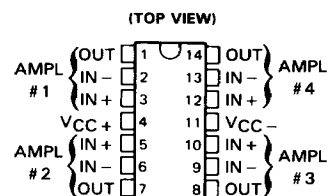

NC—No internal connection

PRODUCTION DATA documents contain information current as of publication date. Products conform to specifications per the terms of Texas Instruments standard warranty. Production processing does not necessarily include testing of all parameters.

TEXAS
INSTRUMENTS

POST OFFICE BOX 655012 • DALLAS, TEXAS 75265

Copyright © 1983, Texas Instruments Incorporated

2-403

**TL080 THRU TL085, TL080A THRU TL084A
TL081B, TL082B, TL084B
JFET-INPUT OPERATIONAL AMPLIFIERS**

**TL083M . . . FK CHIP CARRIER PACKAGE
(TOP VIEW)**

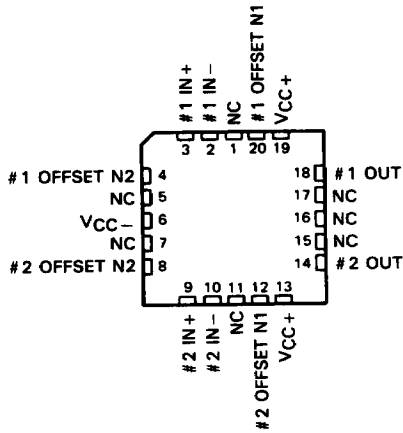

**TL084M . . . FK CHIP CARRIER PACKAGE
(TOP VIEW)**

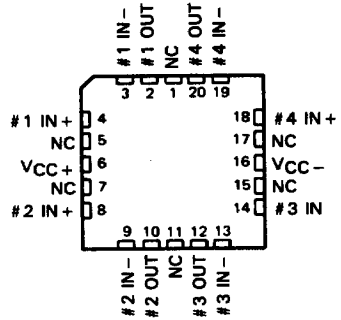

**TL085
N PACKAGE
(TOP VIEW)**

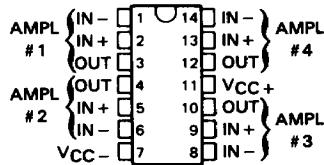

NC—No internal connection

symbols

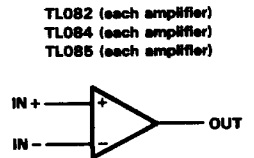
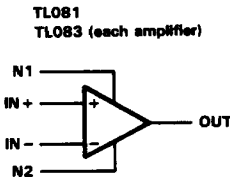
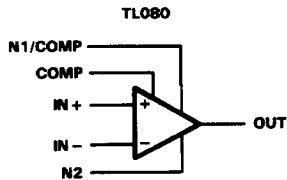

**TL080 THRU TL085, TL080A THRU TL084A
TL081B, TL082B, TL084B
JFET-INPUT OPERATIONAL AMPLIFIERS**

description

The TL08_ JFET-input operational amplifier family is designed to offer a wider selection than any previously developed operational amplifier family. Each of these JFET-input operational amplifiers incorporates well-matched, high-voltage JFET and bipolar transistors in a monolithic integrated circuit. The devices feature high slew rates, low input bias and offset currents, and low offset voltage temperature coefficient. Offset adjustment and external compensation options are available within the TL08_ family.

Device types with an "M" suffix are characterized for operation over the full military temperature range of -55°C to 125°C, those with an "I" suffix are characterized for operation from -40°C to 85°C, and those with a "C" suffix are characterized for operation from 0°C to 70°C.

AVAILABLE OPTIONS

T _A	V _{IO} MAX AT 25°C	PACKAGE					
		SMALL OUTLINE (D)	CHIP CARRIER (FK)	CERAMIC DIP (J)	CERAMIC DIP (JG)	PLASTIC DIP (N)	PLASTIC DIP (P)
0°C TO 70°C	15 mV	TL080CD			TL080CJG		TL080CP
	6 mV	TL080ACD			TL080ACJG		TL080ACP
	15 mV	TL081CD			TL081CJG		TL081CP
	6 mV	TL081ACD			TL081ACJG		TL081ACP
	3 mV	TL081BCD			TL081BCJG		TL081BCP
	15 mV	TL082CD			TL082CJG		TL082CP
	6 mV	TL082ACD			TL082ACJG		TL082ACP
	3 mV	TL082BCD			TL082BCJG		TL082BCP
	15 mV	TL083CD		TL083CJ		TL083CN	
	6 mV	TL083ACD		TL083ACJ		TL083ACN	
	15 mV	TL084CD		TL084CJ		TL084CN	
	6 mV	TL084ACD		TL084ACJ		TL084ACN	
3 mV	TL084BCD		TL084BCJ		TL084BCN		
15 mV					TL085CN		
-40°C TO 85°C	6 mV	TL080ID			TL080IJG		TL080IP
	6 mV	TL081ID			TL081IJG		TL081IP
	6 mV	TL082ID			TL082IJG		TL082IP
	6 mV	TL083ID		TL083IJ		TL083IN	
6 mV	TL084ID		TL084IJ		TL084IN		
-55°C TO 125°C	6 mV		TL081MFK		TL080MJG		
	6 mV		TL082MFK		TL081MJG		
	6 mV		TL083MFK	TL083MJ	TL082MJG		
	6 mV		TL084MFK	TL084MJ			

The D package is available taped and reeled. Add "R" suffix to device type (e.g., TL080CDR).

2

Operational Amplifiers



POST OFFICE BOX 655012 • DALLAS, TEXAS 75265

2-405

**TL080 THRU TL085, TL080A THRU TL084A
TL081B, TL082B, TL084B
JFET-INPUT OPERATIONAL AMPLIFIERS**

schematic (each amplifier)

2

Operational Amplifiers

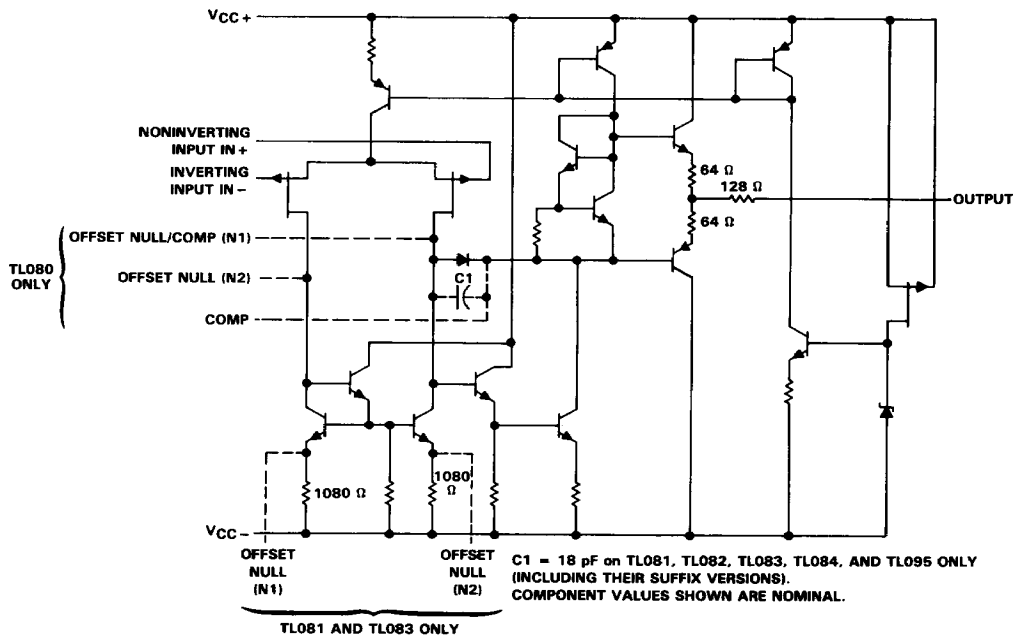

absolute maximum ratings over operating free-air temperature range (unless otherwise noted)

	TL08_M	TL08_I	TL08_C TL08_AC TL08_BC	UNIT
Supply voltage, VCC+ (see Note 1)	18	18	18	V
Supply voltage, VCC- (see Note 1)	-18	-18	-18	V
Differential input voltage (see Note 2)	± 30	± 30	± 30	V
Input voltage (see Notes 1 and 3)	± 15	± 15	± 15	V
Duration of output short circuit (see Note 4)	unlimited	unlimited	unlimited	
Continuous total dissipation	See Dissipation Rating Table			
Operating free-air temperature range	-55 to 125	-40 to 85	0 to 70	$^{\circ}\text{C}$
Storage temperature range	-65 to 150	-65 to 150	-65 to 150	$^{\circ}\text{C}$
Case temperature for 60 seconds	260			
Lead temperature 1,6 mm (1/16 inch) from case for 60 seconds	300			
Lead temperature 1,6 mm (1/16 inch) from case for 10 seconds	260			

- NOTES: 1. All voltage values, except differential voltages, are with respect to the midpoint between VCC+ and VCC-.
2. Differential voltages are at the noninverting input terminal with respect to the inverting input terminal.
3. The magnitude of the input voltage must never exceed the magnitude of the supply voltage or 15 V, whichever is less.
4. The output may be shorted to ground or to either supply. Temperature and/or supply voltages must be limited to ensure that the dissipation rating is not exceeded.

**TL080 THRU TL085, TL080A THRU TL084A
TL081B, TL082B, TL084B
JFET-INPUT OPERATIONAL AMPLIFIERS**

DISSIPATION RATING TABLE

PACKAGE	$T_A \leq 25^\circ\text{C}$		DERATING FACTOR	DERATE ABOVE T_A	$T_A = 70^\circ\text{C}$		$T_A = 85^\circ\text{C}$		$T_A = 125^\circ\text{C}$	
	POWER RATING				POWER RATING		POWER RATING		POWER RATING	
D (8 Pin)	680 mW		5.8 mW/°C	32°C	464 mW		377 mW		N/A	
D (14 Pin)	680 mW		7.6 mW/°C	60°C	608 mW		494 mW		N/A	
FK	680 mW		11.0 mW/°C	88°C	680 mW		680 mW		275 mW	
J (TL08_M)	680 mW		11.0 mW/°C	88°C	680 mW		680 mW		275 mW	
J (all others)	680 mW		8.2 mW/°C	67°C	656 mW		533 mW		N/A	
JG (TL08_M)	680 mW		8.4 mW/°C	69°C	672 mW		546 mW		210 mW	
JG (all others)	680 mW		6.6 mW/°C	47°C	528 mW		429 mW		N/A	
N	680 mW		9.2 mW/°C	76°C	680 mW		598 mW		N/A	
P	680 mW		8.0 mW/°C	65°C	640 mW		520 mW		N/A	

2

electrical characteristics, $V_{CC\pm} = \pm 15\text{ V}$ (unless otherwise noted)

PARAMETER	TEST CONDITIONS†		TL080M, TL081M TL082M, TL083M			TL084M			UNIT
			MIN	TYP	MAX	MIN	TYP	MAX	
			V_{IO}	Input offset voltage	$V_O = 0,$ $R_S = 50\ \Omega$	$T_A = 25^\circ\text{C}$			
		$T_A = -55^\circ\text{C to } 125^\circ\text{C}$			$T_A = -55^\circ\text{C to } 125^\circ\text{C}$				
α_{VIO}	Temperature coefficient of input offset voltage	$V_O = 0,$ $T_A = -55^\circ\text{C to } 125^\circ\text{C}$	$R_S = 50\ \Omega,$			$R_S = 50\ \Omega,$			$\mu\text{V}/^\circ\text{C}$
I_{IO}	Input offset current‡	$V_O = 0$	$T_A = 25^\circ\text{C}$			$T_A = 25^\circ\text{C}$			pA
			$T_A = 125^\circ\text{C}$			$T_A = 125^\circ\text{C}$			nA
I_{IB}	Input bias current‡	$V_O = 0$	$T_A = 25^\circ\text{C}$			$T_A = 25^\circ\text{C}$			pA
			$T_A = 125^\circ\text{C}$			$T_A = 125^\circ\text{C}$			nA
V_{ICR}	Common-mode input voltage range	$T_A = 25^\circ\text{C}$	-12 to 15			-12 to 15			V
V_{OM}	Maximum peak output voltage swing	$T_A = 25^\circ\text{C},$ $T_A = -55^\circ\text{C to } 125^\circ\text{C}$	$R_L = 10\ \text{k}\Omega$ $R_L \geq 10\ \text{k}\Omega$ $R_L \geq 2\ \text{k}\Omega$			$R_L = 10\ \text{k}\Omega$ $R_L \geq 10\ \text{k}\Omega$ $R_L \geq 2\ \text{k}\Omega$			V
A_{VD}	Large-signal differential voltage amplification	$V_O = \pm 10\ \text{V},$ $T_A = 25^\circ\text{C}$	$R_L \geq 2\ \text{k}\Omega$			$R_L \geq 2\ \text{k}\Omega$			V/mV
		$V_O = \pm 10\ \text{V},$ $T_A = -55^\circ\text{C to } 125^\circ\text{C}$	$R_L \geq 2\ \text{k}\Omega$			$R_L \geq 2\ \text{k}\Omega$			V/mV
B_1	Unity-gain bandwidth	$T_A = 25^\circ\text{C}$	3			3			MHz
r_i	Input resistance	$T_A = 25^\circ\text{C}$	10^{12}			10^{12}			Ω
CMRR	Common-mode rejection ratio	$V_{IC} = V_{ICR\ min},$ $R_S = 50\ \Omega,$	$V_O = 0,$ $T_A = 25^\circ\text{C}$			$V_O = 0,$ $T_A = 25^\circ\text{C}$			dB
kSVR	Supply voltage rejection ratio ($\Delta V_{CC\pm}/\Delta V_{IO}$)	$V_{CC} = \pm 15\ \text{V to } \pm 9\ \text{V},$ $R_S = 50\ \Omega,$	$V_O = 0,$ $T_A = 25^\circ\text{C}$			$V_O = 0,$ $T_A = 25^\circ\text{C}$			dB
I_{CC}	Supply current (per amplifier)	No load, $T_A = 25^\circ\text{C}$	$V_O = 0,$			$V_O = 0,$			mA
V_{O1}/V_{O2}	Crosstalk attenuation	$A_{VD} = 100,$	$T_A = 25^\circ\text{C}$			$T_A = 25^\circ\text{C}$			dB

† All characteristics are measured under open-loop conditions with zero common-mode input voltage unless otherwise specified.
‡ Input bias currents of a FET-input operational amplifier are normal junction reverse currents, which are temperature sensitive as shown in Figure 18. Pulse techniques must be used that will maintain the junction temperatures as close to the ambient temperature as is possible.

Operational Amplifiers



POST OFFICE BOX 655012 • DALLAS, TEXAS 75265

**TL080 THRU TL085, TL080A THRU TL084A
TL081B, TL082B, TL084B
JFET-INPUT OPERATIONAL AMPLIFIERS**

2
Operational Amplifiers

electrical characteristics, $V_{CC} \pm = \pm 15$ V (unless otherwise noted)

PARAMETER	TEST CONDITIONS†	TL080I			TL080C			TL080AC			TL081BC			UNIT
		MIN	TYP	MAX	MIN	TYP	MAX	MIN	TYP	MAX	MIN	TYP	MAX	
V_{IO}	$V_O = 0$, $R_S = 50 \Omega$	3	6	6	3	15	15	3	6	6	2	3	mV	
Temperature coefficient of input offset voltage	$V_O = 0$, $R_S = 50 \Omega$, $T_A = \text{full range}$	18			18			18			18		$\mu\text{V}/^\circ\text{C}$	
I_{IO}	$V_O = 0$	5	100	10	5	200	2	5	100	5	100	5	pA	
I_{IB}	$V_O = 0$	30	200	20	30	400	2	30	200	30	200	30	nA	
V_{ICR}	$T_A = 25^\circ\text{C}$	± 11	to	15	± 11	to	15	± 11	to	15	± 11	to	V	
V_{OM}	$T_A = 25^\circ\text{C}$, $R_L = 10 \text{ k}\Omega$	± 12	± 13.5		± 12	± 13.5		± 12	± 13.5		± 12	± 13.5	V	
Large-signal differential voltage amplification	$V_O = \pm 10$ V, $R_L \geq 2 \text{ k}\Omega$, $T_A = 25^\circ\text{C}$	50	200	25	200	25	200	50	200	50	200	200	V/mV	
B_1	Unity-gain bandwidth	3			3			3		3			MHz	
f_t	Input resistance	10 ¹²			10 ¹²			10 ¹²		10 ¹²			Ω	
CMRR	Common-mode rejection ratio	80	86	80	70	86	80	86	80	86	80	86	dB	
k_{SVR}	Supply voltage rejection ratio	80	86	80	70	86	80	86	80	86	80	86	dB	
I_{CC}	Supply current (per amplifier)	1.4	2.8	1.4	2.8	2.8	1.4	2.8	1.4	2.8	1.4	2.8	mA	
V_{O1}/V_{O2}	Crosstalk attenuation	120			120			120		120			dB	

† All characteristics are measured under open-loop conditions with zero common-mode input voltage unless otherwise specified. Full range for T_A is -40°C to 85°C for TL080 and 0°C to 70°C for TL080A, TL080B, TL080C, TL080AC, and TL080BC.
‡ Input bias currents of a JFET-input operational amplifier are normal junction reverse currents, which are temperature sensitive as shown in Figure 18. Pulse techniques must be used that will maintain the junction temperatures as close to the ambient temperature as possible.

TL080 THRU TL085, TL080A THRU TL084A
TL081B, TL082B, TL084B
JFET-INPUT OPERATIONAL AMPLIFIERS

operating characteristics, $V_{CC} \pm = \pm 15 \text{ V}$, $T_A = 25^\circ \text{C}$

PARAMETER	TEST CONDITIONS		MIN	TYP	MAX	UNIT
SR Slew rate at unity gain	$V_i = 10 \text{ V}$, $C_L = 100 \text{ pF}$,	$R_L = 2 \text{ k}\Omega$, See Figure 1	8	13		$\text{V}/\mu\text{s}$
t_r Rise time	$V_i = 20 \text{ mV}$,	$R_L = 2 \text{ k}\Omega$,		0.05		μs
Overshoot factor	$C_L = 100 \text{ pF}$,	See Figure 1		20%		
V_n Equivalent input noise voltage	$R_S = 100 \Omega$	$f = 1 \text{ kHz}$		18		$\text{nV}/\sqrt{\text{Hz}}$
		$f = 10 \text{ Hz to } 10 \text{ kHz}$		4		μV
I_n Equivalent input noise current	$R_S = 100 \Omega$,	$f = 1 \text{ kHz}$		0.01		$\text{pA}/\sqrt{\text{Hz}}$
THD Total harmonic distortion	$V_{O(\text{rms})} = 10 \text{ V}$,	$R_S \leq 1 \text{ k}\Omega$, $R_L \geq 2 \text{ k}\Omega$,		0.003%		

2

PARAMETER MEASUREMENT INFORMATION

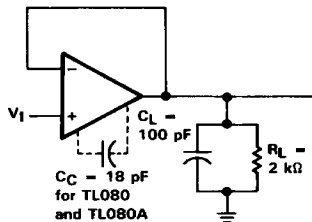

FIGURE 1. UNITY-GAIN AMPLIFIER

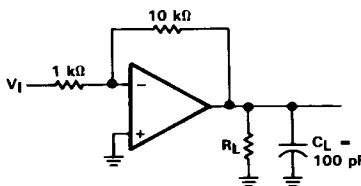

FIGURE 2. GAIN-OF-10
INVERTING AMPLIFIER

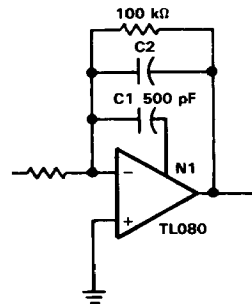

FIGURE 3. FEED-FORWARD
COMPENSATION

INPUT OFFSET VOLTAGE NULL CIRCUITS

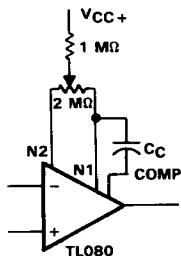

FIGURE 4

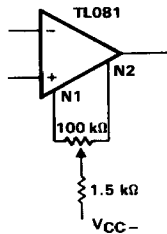

FIGURE 5

Operational Amplifiers

**TL080 THRU TL085, TL080A THRU TL084A
TL081B, TL082B, TL084B
JFET-INPUT OPERATIONAL AMPLIFIERS**

TYPICAL CHARACTERISTICS†

2

Operational Amplifiers

**MAXIMUM PEAK OUTPUT VOLTAGE
vs
FREQUENCY**

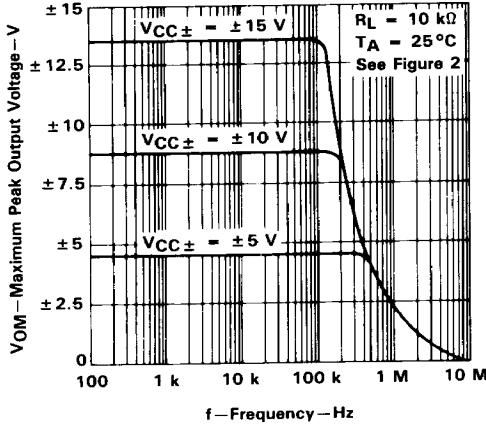

FIGURE 6

**MAXIMUM PEAK OUTPUT VOLTAGE
vs
FREQUENCY**

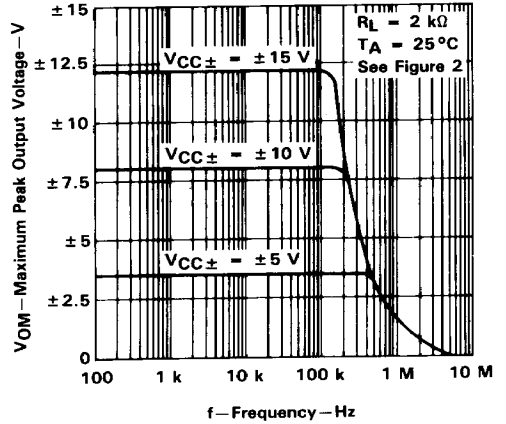

FIGURE 7

**MAXIMUM PEAK OUTPUT VOLTAGE
vs
FREQUENCY**

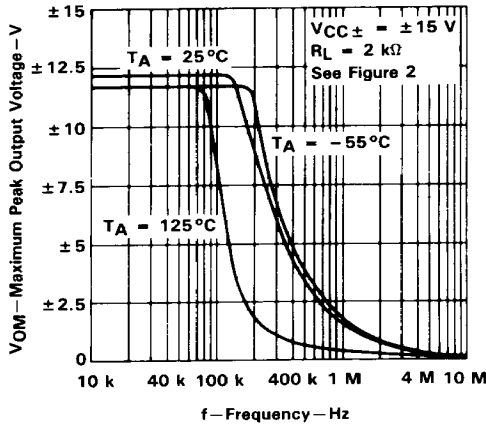

FIGURE 8

**MAXIMUM PEAK OUTPUT VOLTAGE
vs
FREE-AIR TEMPERATURE**

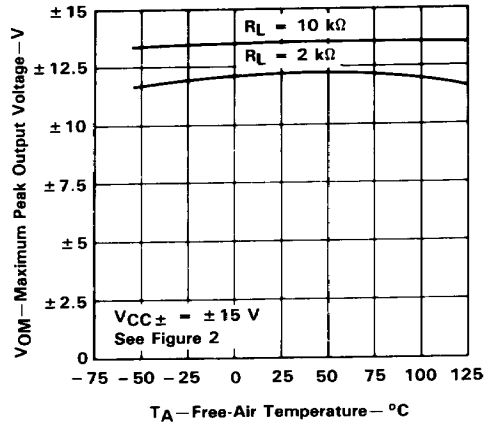

FIGURE 9

† Data at high and low temperatures are applicable only within the rated operating free-air temperature ranges of the various devices. A 12-pF compensation capacitor is used with TL080 and TL080A.

**TL080 THRU TL085, TL080A THRU TL084A
TL081B, TL082B, TL084B
JFET-INPUT OPERATIONAL AMPLIFIERS**

TYPICAL CHARACTERISTICS†

**MAXIMUM PEAK OUTPUT VOLTAGE
vs
LOAD RESISTANCE**

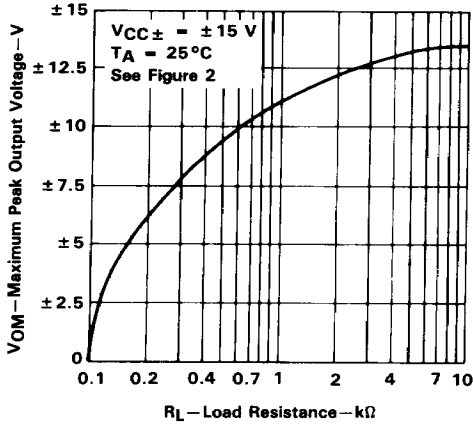

FIGURE 10

**MAXIMUM PEAK OUTPUT VOLTAGE
vs
SUPPLY VOLTAGE**

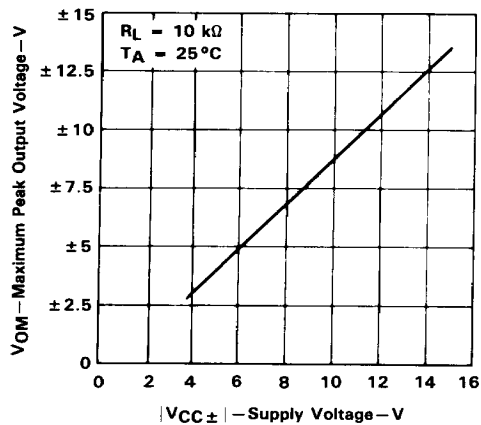

FIGURE 11

**LARGE-SIGNAL
DIFFERENTIAL VOLTAGE AMPLIFICATION
vs
FREE-AIR TEMPERATURE**

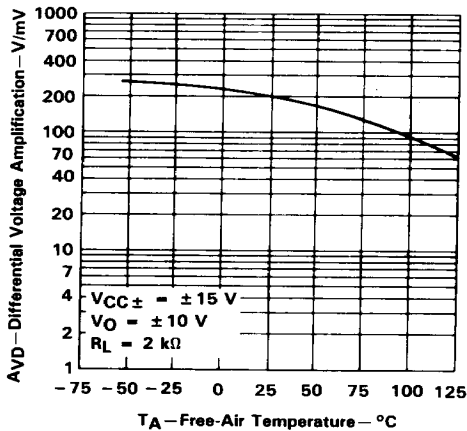

FIGURE 12

**LARGE-SIGNAL
DIFFERENTIAL VOLTAGE AMPLIFICATION
and PHASE SHIFT
vs
FREQUENCY**

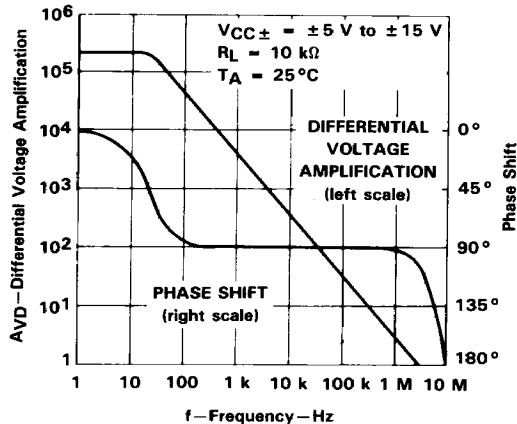

FIGURE 13

† Data at high and low temperatures are applicable only within the rated operating free-air temperature ranges of the various devices. A 12-pF compensation capacitor is used with TL080 and TL080A.

**TL080 THRU TL085, TL080A THRU TL084A
TL081B, TL082B, TL084B
JFET-INPUT OPERATIONAL AMPLIFIERS**

TYPICAL CHARACTERISTICS†

2 Operational Amplifiers

**TL080, TL080A
DIFFERENTIAL VOLTAGE AMPLIFICATION
vs
FREQUENCY WITH FEED-FORWARD COMPENSATION**

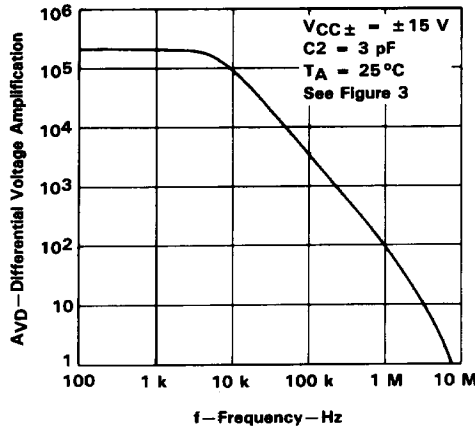

FIGURE 14

**TOTAL POWER DISSIPATED
vs
FREE-AIR TEMPERATURE**

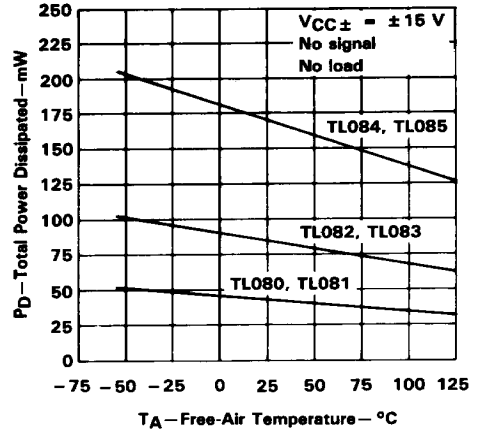

FIGURE 15

**SUPPLY CURRENT PER AMPLIFIER
vs
FREE-AIR TEMPERATURE**

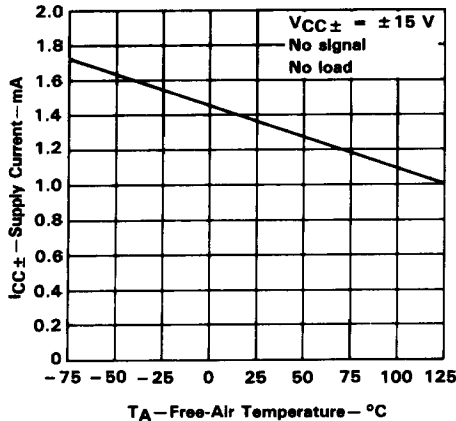

FIGURE 16

**SUPPLY CURRENT
vs
SUPPLY VOLTAGE**

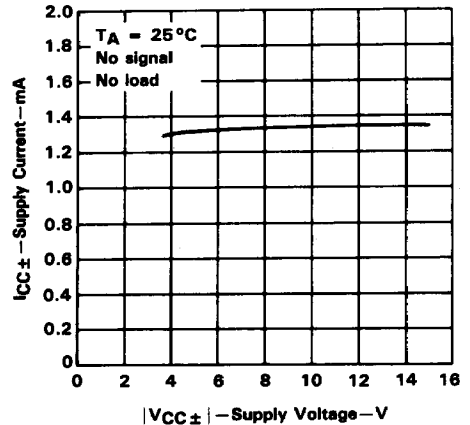

FIGURE 17

† Data at high and low temperatures are applicable only within the rated operating free-air temperature ranges of the various devices. A 12-pF compensation capacitor is used with TL080 and TL080A.

**TL080 THRU TL085, TL080A THRU TL084A
TL081B, TL082B, TL084B
JFET-INPUT OPERATIONAL AMPLIFIERS**

TYPICAL CHARACTERISTICS†

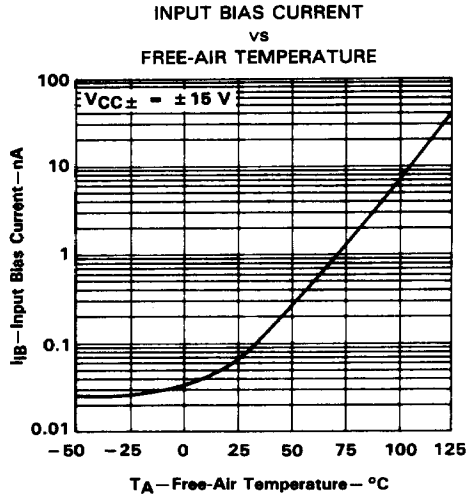

FIGURE 18

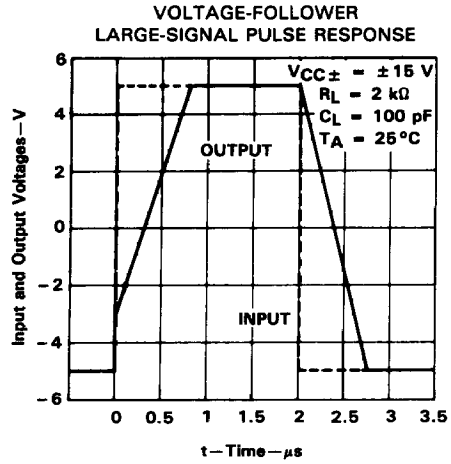

FIGURE 19

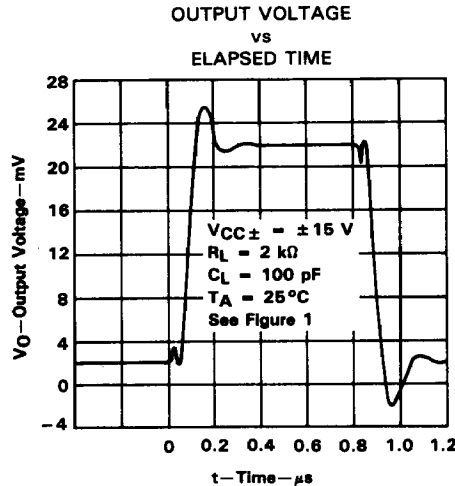

FIGURE 20

† Data at high and low temperatures are applicable only within the rated operating free-air temperature ranges of the various devices. A 12-pF compensation capacitor is used with TL080 and TL080A.

**TL080 THRU TL085, TL080A THRU TL084A
TL081B, TL082B, TL084B
JFET-INPUT OPERATIONAL AMPLIFIERS**

TYPICAL CHARACTERISTICS†

**2
Operational Amplifiers**

**COMMON-MODE REJECTION RATIO
vs
FREE-AIR TEMPERATURE**

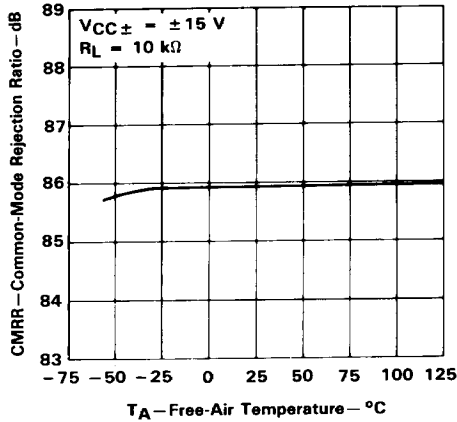

**EQUIVALENT INPUT NOISE VOLTAGE
vs
FREQUENCY**

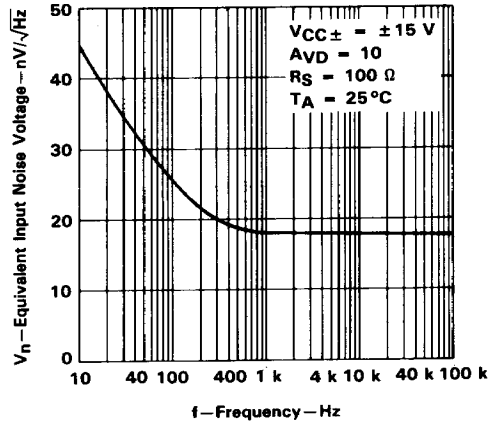

**TOTAL HARMONIC DISTORTION
vs
FREQUENCY**

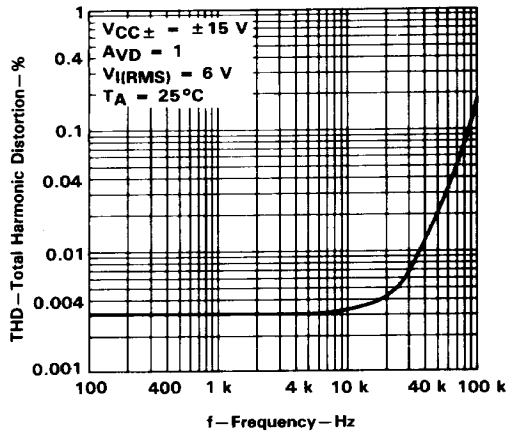

† Data at high and low temperatures are applicable only within the rated operating free-air temperature ranges of the various devices. A 12-pF compensation capacitor is used with TL080 and TL080A.

TYPICAL APPLICATION DATA

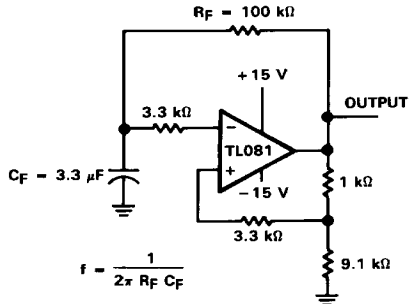

FIGURE 24. 0.5-Hz SQUARE-WAVE OSCILLATOR

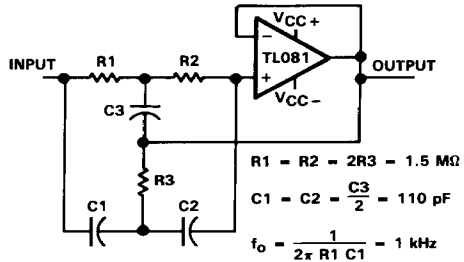

FIGURE 25. HIGH-Q NOTCH FILTER

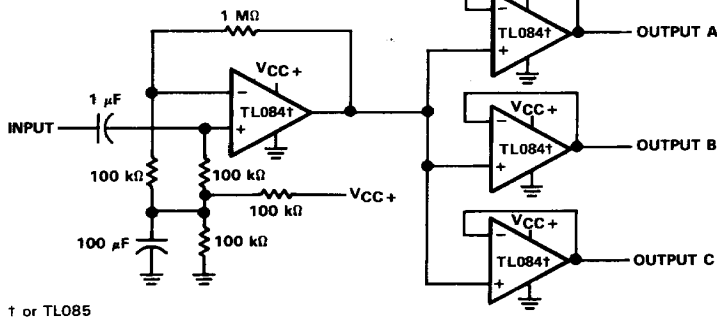

FIGURE 26. AUDIO DISTRIBUTION AMPLIFIER

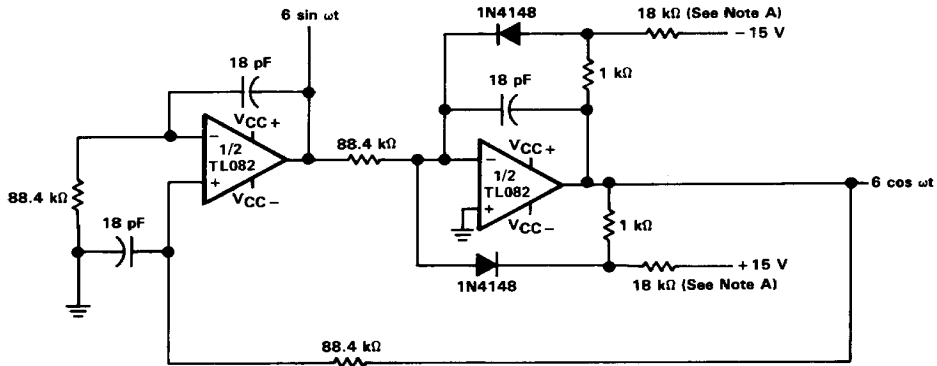
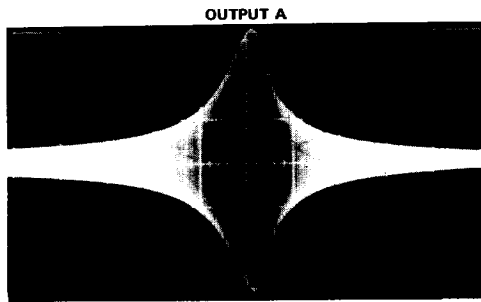
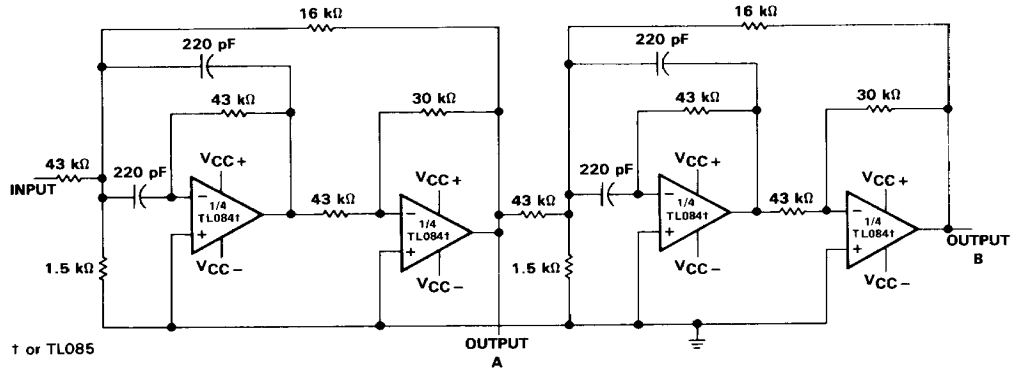

FIGURE 27. 100-KHZ QUADRATURE OSCILLATOR

**TL080 THRU TL085, TL080A THRU TL084A
TL081B, TL082B, TL084B
JFET-INPUT OPERATIONAL AMPLIFIERS**

TYPICAL APPLICATION DATA



2 kHz/div
SECOND-ORDER BANDPASS FILTER
 $f_0 = 100 \text{ kHz}$, $Q = 30$, GAIN = 4

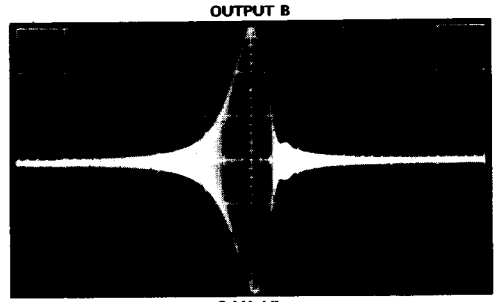

2 kHz/div
CASCADED BANDPASS FILTER
 $f_0 = 100 \text{ kHz}$, $Q = 89$, GAIN = 16

FIGURE 28. POSITIVE-FEEDBACK BANDPASS FILTER

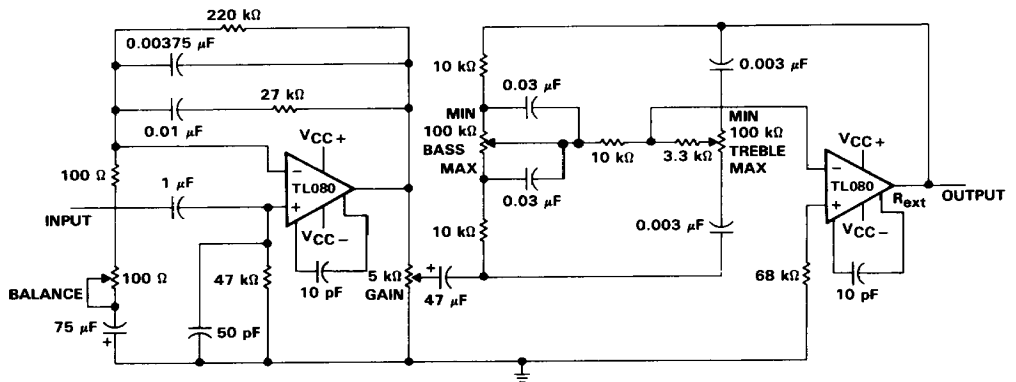

FIGURE 29. IC PREAMPLIFIER