

3V INPUT/OUTPUT RAIL TO RAIL DUAL CMOS OPERATIONAL AMPLIFIER (WITH STANDBY POSITION)

- DEDICATED TO 3.3V OR BATTERY SUPPLY (specified at 3V and 5V)
- RAIL TO RAIL INPUT AND OUTPUT VOLTAGE RANGES
- **STANDBY POSITION** : REDUCED CONSUMPTION (1 μ A) AND HIGH IMPEDANCE OUTPUTS
- SINGLE (OR DUAL) SUPPLY OPERATION FROM 2.7V TO 16V
- EXTREMELY LOW INPUT BIAS CURRENT : 1pA TYP
- LOW INPUT OFFSET VOLTAGE : 1.5mV max.
- SPECIFIED FOR 600 Ω AND 100 Ω LOADS
- LOW SUPPLY CURRENT : 200 μ A/Ampli

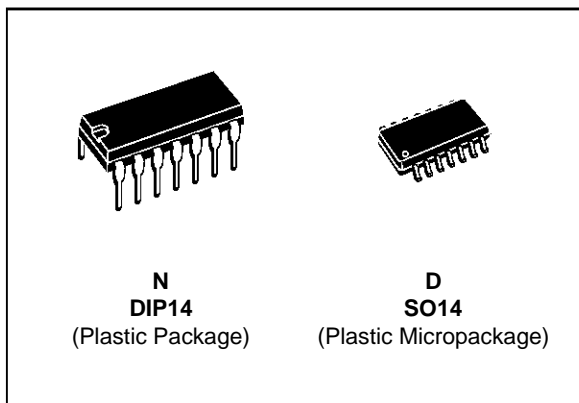

ORDER CODES

Part Number	Temperature Range	Package	
		N	D
TS3V902I/AI/BI	-40, +125 $^{\circ}$ C	•	•

PIN CONNECTIONS (top view)

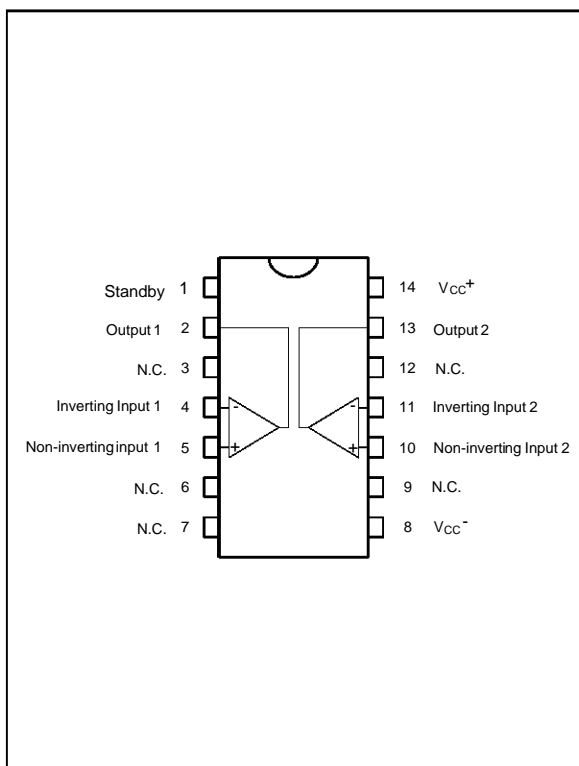

DESCRIPTION

The TS3V902 is a RAIL TO RAIL dual CMOS operational amplifier designed to operate with single or dual supply voltage.

The input voltage range V_{icm} includes the two supply rails V_{cc}^+ and V_{cc}^- .

The output reaches :

- $V_{cc}^- + 50mV$ $V_{cc}^+ - 50mV$ with $R_L = 10k\Omega$
- $V_{cc}^- + 350mV$ $V_{cc}^+ - 350mV$ with $R_L = 600\Omega$

This product offers a broad supply voltage operating range from 2.7V to 16V and a supply current of only 200 μ A/amp. ($V_{cc} = 3V$).

Source and sink output current capability is typically 40mA (at $V_{cc} = 3V$), fixed by an internal limitation circuit.

The TS3V902 can be put on STANDBY position (only 0.5 μ A and high impedance outputs).

TS3V902

SCHEMATIC DIAGRAM (1/2 TS3V902)

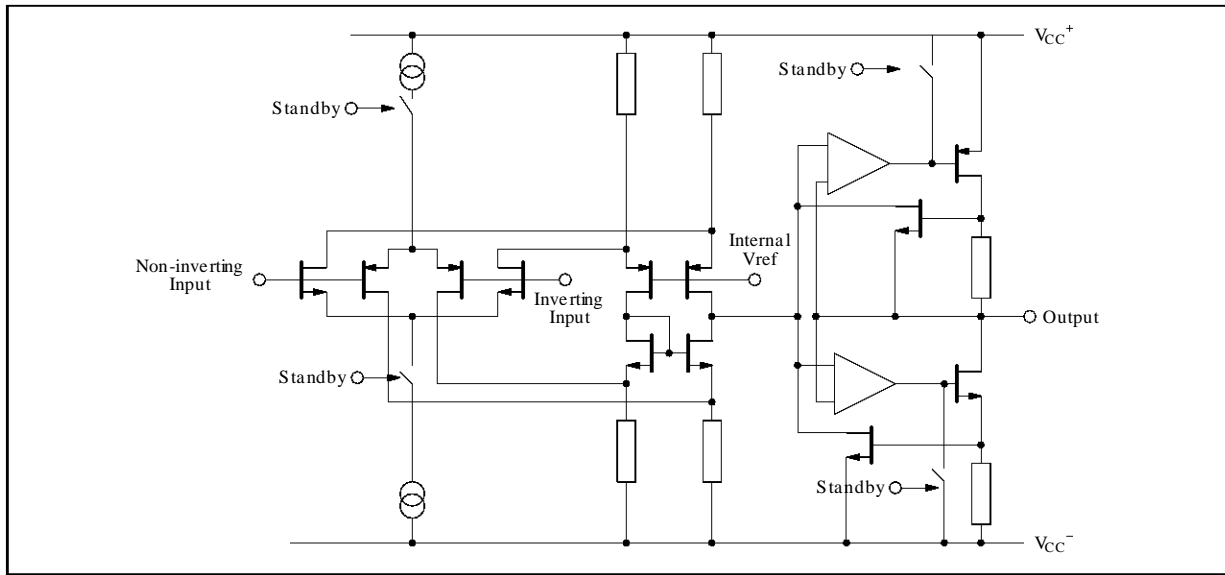

STANDBY POSITION

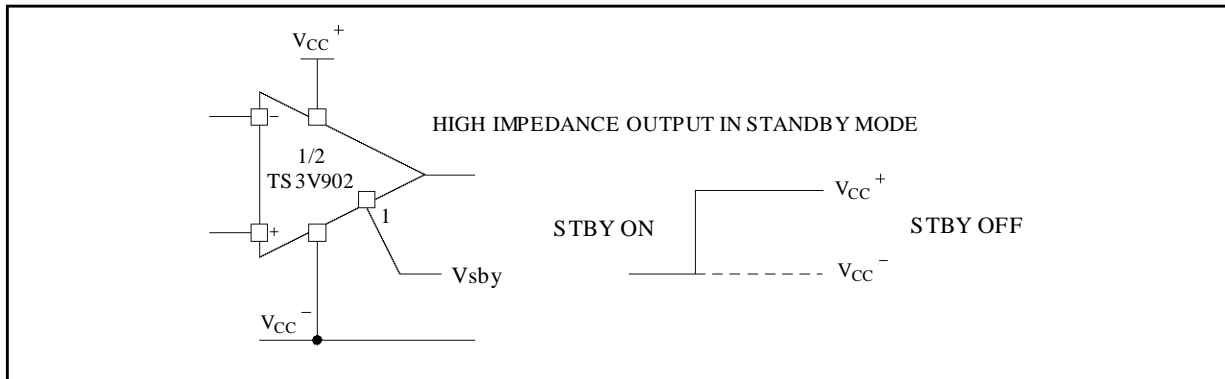

ABSOLUTE MAXIMUM RATINGS

Symbol	Parameter	Value	Unit
V_{CC}	Supply Voltage - (note 1)	18	V
V_{id}	Differential Input Voltage - (note 2)	± 18	V
V_i	Input Voltage - (note 3)	-0.3 to 18	V
I_{in}	Current on Inputs	± 50	mA
I_o	Current on Outputs	± 130	mA
T_{oper}	Operating Free Air Temperature Range	-40 to +125	$^{\circ}C$
T_{stg}	Storage Temperature	-65 to +150	$^{\circ}C$

- Notes :**
1. All voltage values, except differential voltage are with respect to network ground terminal.
 2. Differential voltages are the non-inverting input terminal with respect to the inverting input terminal.
 3. The magnitude of input and output voltages must never exceed $V_{CC}^{+} + 0.3V$.

OPERATING CONDITIONS

Symbol	Parameter	Value	Unit
V_{CC}	Supply Voltage	2.7 to 16	V
V_{icm}	Common Mode Input Voltage Range	$V_{CC}^{-} - 0.2$ to $V_{CC}^{+} + 0.2$	V

ELECTRICAL CHARACTERISTICS
 $V_{CC}^+ = 3V$, $V_{CC}^- = 0V$, R_L, C_L connected to $V_{CC}/2$, Standby OFF, $T_{amb} = 25^\circ C$
(unless otherwise specified)

Symbol	Parameter	TS3V902I/AI/BI			Unit
		Min.	Typ.	Max.	
V_{io}	Input Offset Voltage ($V_{ic} = V_o = V_{CC}/2$) $T_{min.} \leq T_{amb} \leq T_{max.}$			12 5 1.5 12 7 3	mV
DV_{io}	Input Offset Voltage Drift		5		$\mu V/^\circ C$
I_{io}	Input Offset Current - (note 1) $T_{min.} \leq T_{amb} \leq T_{max.}$		1	100 200	pA
I_{ib}	Input Bias Current - (note 1) $T_{min.} \leq T_{amb} \leq T_{max.}$		1	150 300	pA
I_{CC}	Supply Current (per amplifier, $A_{VCL} = 1$, no load) $T_{min.} \leq T_{amb} \leq T_{max.}$		200	300 400	μA
CMR	Common Mode Rejection Ratio $V_{ic} = 0$ to $3V$, $V_o = 1.5V$		60		dB
SVR	Supply Voltage Rejection Ratio ($V_{CC}^+ = 2.7$ to $3.3V$, $V_o = V_{CC}/2$)		80		dB
A_{vd}	Large Signal Voltage Gain ($R_L = 10k\Omega$, $V_o = 2.5V$ to $7.5V$) $T_{min.} \leq T_{amb} \leq T_{max.}$	3 3	10		V/mV
V_{OH}	High Level Output Voltage ($V_{id} = 1V$) $T_{min.} \leq T_{amb} \leq T_{max.}$	$R_L = 100k\Omega$ $R_L = 10k\Omega$ $R_L = 600\Omega$ $R_L = 100\Omega$ $R_L = 10k\Omega$ $R_L = 600\Omega$	2.95 2.9 2.2 2.8 2.1	2.96 2.6 2	V
V_{OL}	Low Level Output Voltage ($V_{id} = -1V$) $T_{min.} \leq T_{amb} \leq T_{max.}$	$R_L = 100k\Omega$ $R_L = 10k\Omega$ $R_L = 600\Omega$ $R_L = 100\Omega$ $R_L = 10k\Omega$ $R_L = 600\Omega$		50 100 350 600 900 150 900	mV
I_o	Output Short Circuit Current ($V_{id} = \pm 1V$)	Source ($V_o = V_{CC}^-$) Sink ($V_o = V_{CC}^+$)	40 40		mA
GBP	Gain Bandwidth Product ($A_{VCL} = 100$, $R_L = 10k\Omega$, $C_L = 100pF$, $f = 100kHz$)		0.7		MHz
SR	Slew Rate ($A_{VCL} = 1$, $R_L = 10k\Omega$, $C_L = 100pF$, $V_i = 1.3V$ to $1.7V$)		0.5		V/ μs
ϕ_m	Phase Margin		30		Degrees
e_n	Equivalent Input Noise Voltage ($R_s = 100\Omega$, $f = 1kHz$)		30		$\frac{nV}{\sqrt{Hz}}$
V_{O1}/V_{O2}	Channel Separation ($f = 1kHz$)		120		dB

STANDBY MODE
 $V_{CC}^+ = 3V$, $V_{CC}^- = 0V$, $T_{amb} = 25^\circ C$ (unless otherwise specified)

Symbol	Parameter	TS902I/AI/BI			Unit
		Min.	Typ.	Max.	
$V_{inSBY/ON}$	Pin 1 Threshold Voltage for STANDBY ON		1.2		V
$V_{inSBY/OFF}$	Pin 1 Threshold Voltage for STANDBY OFF		1.2		V
$I_{CC SBY}$	Total Consumption in Standby Position (STANDBY ON)		0.5		μA

TS3V902

ELECTRICAL CHARACTERISTICS

$V_{CC}^+ = 5V$, $V_{CC}^- = 0V$, R_L, C_L connected to $V_{CC}/2$, Standby OFF, $T_{amb} = 25^\circ C$
(unless otherwise specified)

Symbol	Parameter	TS3V902I/AI/BI			Unit
		Min.	Typ.	Max.	
V_{io}	Input Offset Voltage ($V_{ic} = V_o = V_{CC}/2$) $T_{min.} \leq T_{amb} \leq T_{max.}$			12 5 1.5 12 7 3	mV
DV_{io}	Input Offset Voltage Drift		5		$\mu V/^\circ C$
I_{io}	Input Offset Current - (note 1) $T_{min.} \leq T_{amb} \leq T_{max.}$		1	100 200	pA
I_{ib}	Input Bias Current - (note 1) $T_{min.} \leq T_{amb} \leq T_{max.}$		1	150 300	pA
I_{CC}	Supply Current (per amplifier, $A_{VCL} = 1$, no load) $T_{min.} \leq T_{amb} \leq T_{max.}$		230	350 450	μA
CMR	Common Mode Rejection Ratio $V_{ic} = 1.5$ to $3.5V$, $V_o = 2.5V$		85		dB
SVR	Supply Voltage Rejection Ratio ($V_{CC}^+ = 2.7$ to $3.3V$, $V_o = V_{CC}/2$)		80		dB
A_{vd}	Large Signal Voltage Gain ($R_L = 10k\Omega$, $V_o = 1.5V$ to $3.5V$) $T_{min.} \leq T_{amb} \leq T_{max.}$	7 7	30		V/mV
V_{OH}	High Level Output Voltage ($V_{id} = 1V$) $T_{min.} \leq T_{amb} \leq T_{max.}$	$R_L = 100k\Omega$ $R_L = 10k\Omega$ $R_L = 600\Omega$ $R_L = 100\Omega$ $R_L = 10k\Omega$ $R_L = 600\Omega$	4.95 4.85 4.2 4.8 4.1	4.9 4.55 3.7	V
V_{OL}	Low Level Output Voltage ($V_{id} = -1V$) $T_{min.} \leq T_{amb} \leq T_{max.}$	$R_L = 100k\Omega$ $R_L = 10k\Omega$ $R_L = 600\Omega$ $R_L = 100\Omega$ $R_L = 10k\Omega$ $R_L = 600\Omega$		50 100 680 1400 150 900	mV
I_o	Output Short Circuit Current ($V_{id} = \pm 1V$)	Source ($V_o = V_{CC}^-$) Sink ($V_o = V_{CC}^+$)	60 60		mA
GBP	Gain Bandwidth Product ($A_{VCL} = 100$, $R_L = 10k\Omega$, $C_L = 100pF$, $f = 100kHz$)		0.8		MHz
SR	Slew Rate ($A_{VCL} = 1$, $R_L = 10k\Omega$, $C_L = 100pF$, $V_i = 1V$ to $4V$)		0.8		V/ μs
ϕ_m	Phase Margin		30		Degrees

STANDBY MODE

$V_{CC}^+ = 5V$, $V_{CC}^- = 0V$, $T_{amb} = 25^\circ C$ (unless otherwise specified)

Symbol	Parameter	TS902I/AI/BI			Unit
		Min.	Typ.	Max.	
$V_{inSBY/ON}$	Pin 1 Threshold Voltage for STANDBY ON		5.2		V
$V_{inSBY/OFF}$	Pin 1 Threshold Voltage for STANDBY OFF		5.2		V
$I_{CC SBY}$	Total Consumption in Standby Position (STANDBY ON)		0.5		μA

TYPICAL CHARACTERISTICS

Figure 1a : Supply Current (each amplifier) versus Supply Voltage

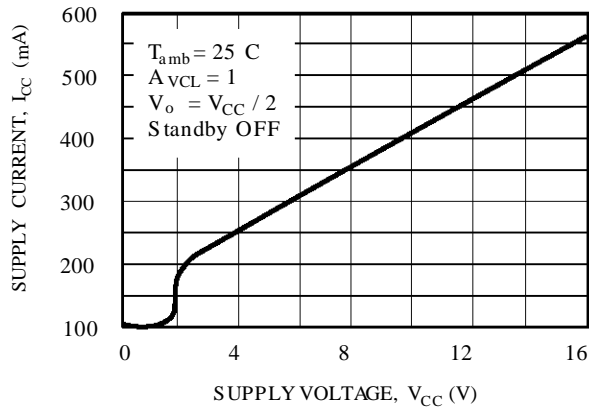

Figure 1b : Supply Current (each amplifier) versus Supply Voltage (in STANDBY)

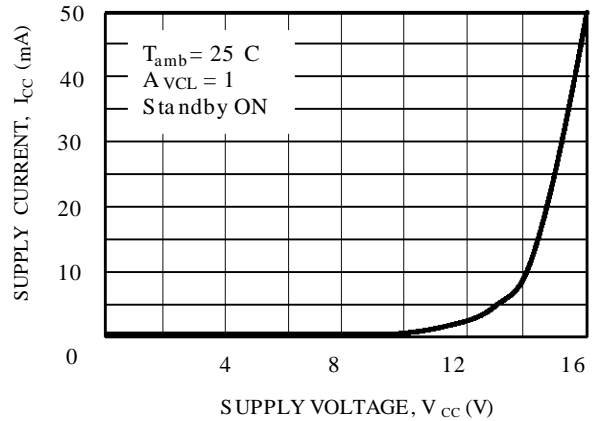

Figure 2 : Input Bias Current versus Temperature

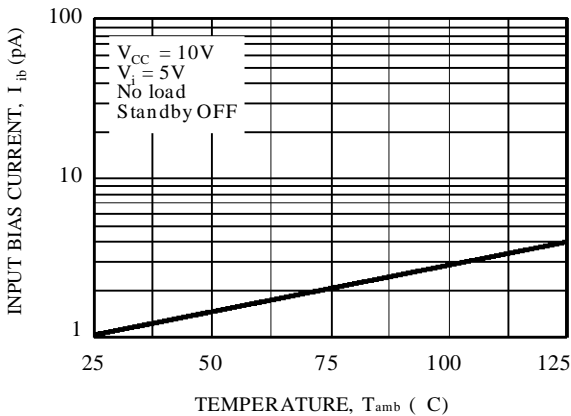

Figure 3a : High Level Output Voltage versus High Level Output Current

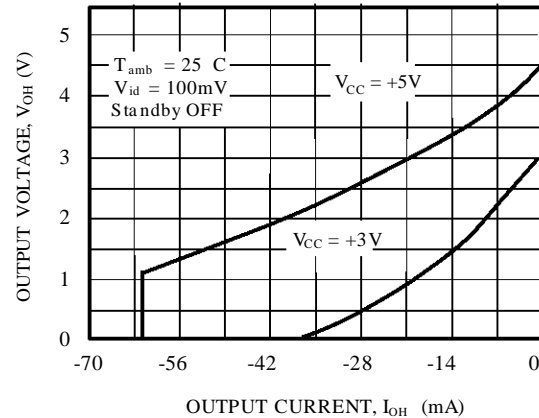

Figure 3b : High Level Output Voltage versus High Level Output Current

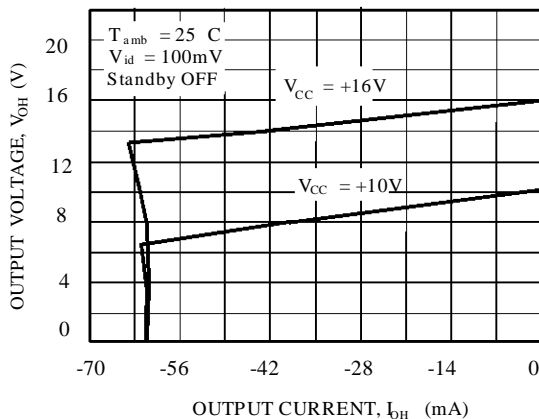

Figure 4a : Low Level Output Voltage versus Low Level Output Current

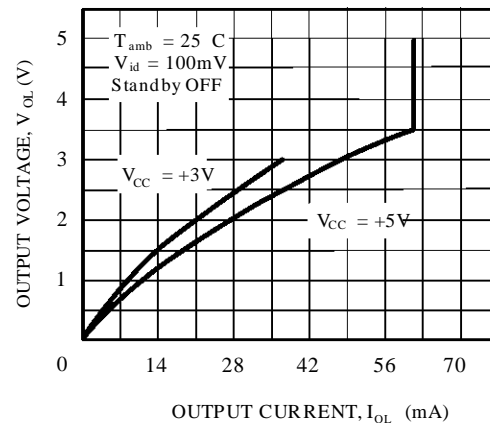

Figure 4b : Low Level Output Voltage versus Low Level Output Current

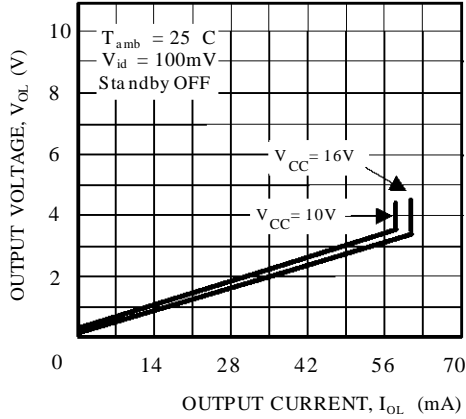

Figure 5a : Open Loop Frequency Response and Phase Shift

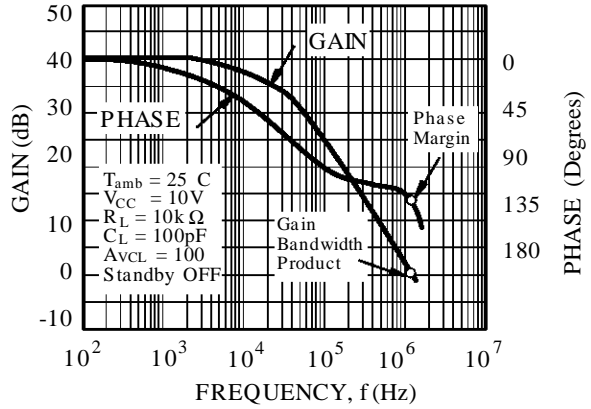

Figure 5b : Open Loop Frequency Response and Phase Shift

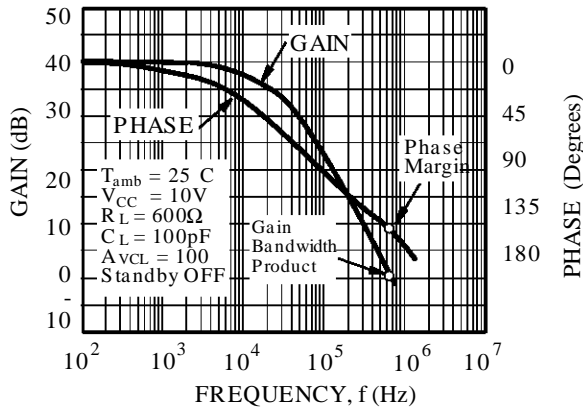

Figure 6a : Gain Bandwidth Product versus Supply Voltage

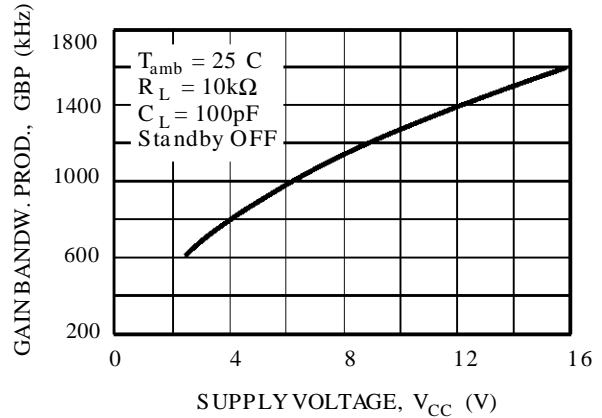

Figure 6b : Gain bandwidth Product versus Supply Voltage

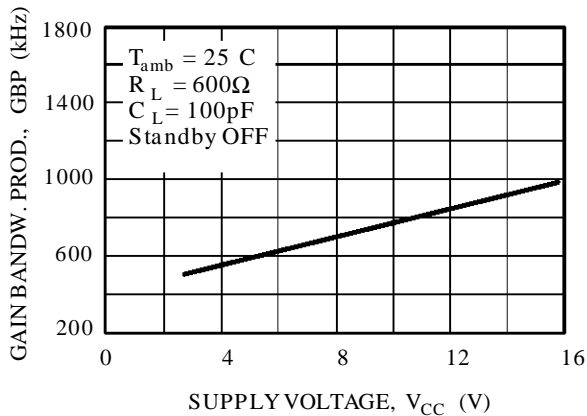

Figure 7a : Phase Margin versus Supply Voltage

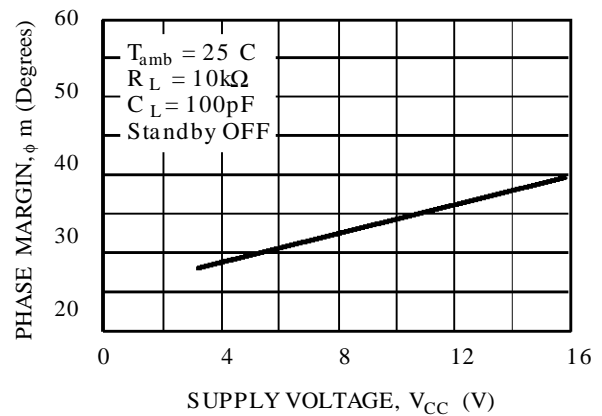

Figure 7b : Phase Margin versus Supply Voltage

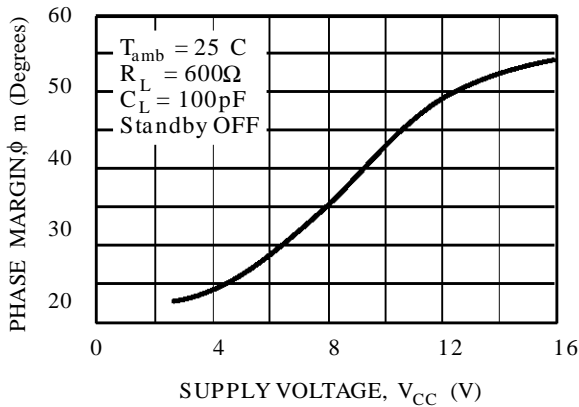
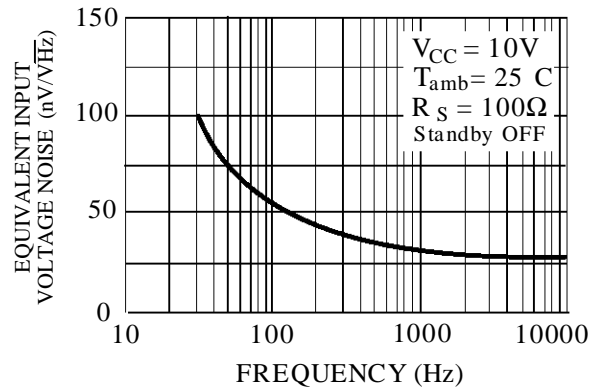

Figure 8 : Input Voltage Noise versus Frequency



STANDBY APPLICATION

The two operators of the TS3V902 are **both** put on **STANDBY**.

In this configuration (standby ON) :

- The **total consumption** of the circuit is considerably **reduced** down to **0.5μA** (V_{CC} = 3V). This standby consumption versus V_{CC} curve is given figure 1b.
- The **both outputs** are in **high impedance** state. No output current can then be sourced or sunk by the device.

The standby pin 1 should never stay unconnected.

- The **"standby OFF"** state, is reached when the pin 1 voltage is **higher than V_{in SBY/OFF}**.
- The **"standby ON"** state is assured by a pin 1 voltage **lower than V_{in SBY/ON}**. (see electrical characteristics)

ORDERING INFORMATION

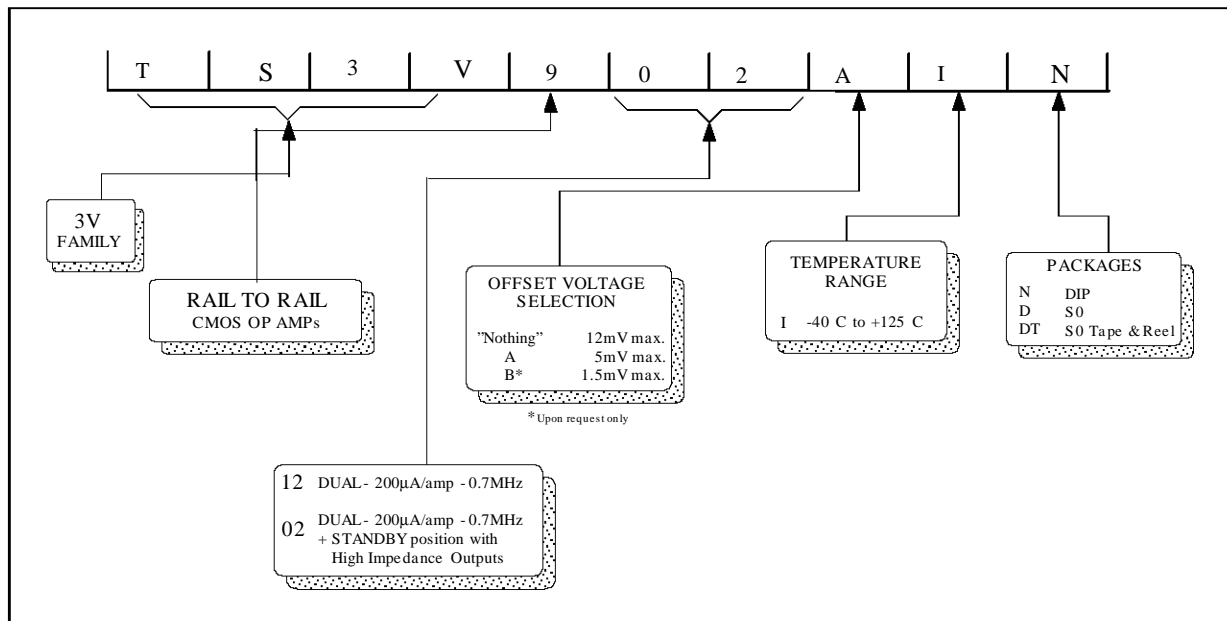

TS3V902

PACKAGE MECHANICAL DATA

14 PINS - PLASTIC DIP

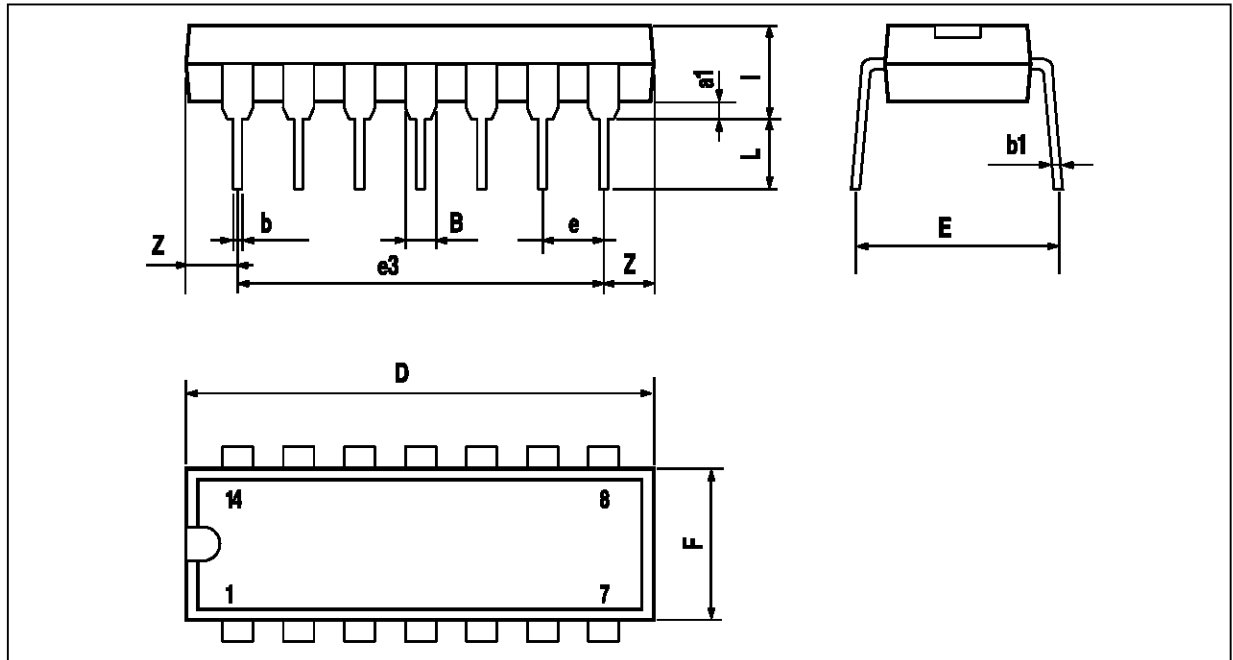

P14-DIP14.EPS

Dimensions	Millimeters			Inches		
	Min.	Typ.	Max.	Min.	Typ.	Max.
a1	0.51			0.020		
B	1.39		1.65	0.055		0.065
b		0.5			0.020	
b1		0.25			0.010	
D			20			0.787
E		8.5			0.335	
e		2.54			0.100	
e3		15.24			0.600	
F			7.1			0.280
i			5.1			0.201
L		3.3			0.130	
Z	1.27		2.54	0.050		0.100

DIP14.TEL

PACKAGE MECHANICAL DATA
 14 PINS - PLASTIC MICROPACKAGE (SO)

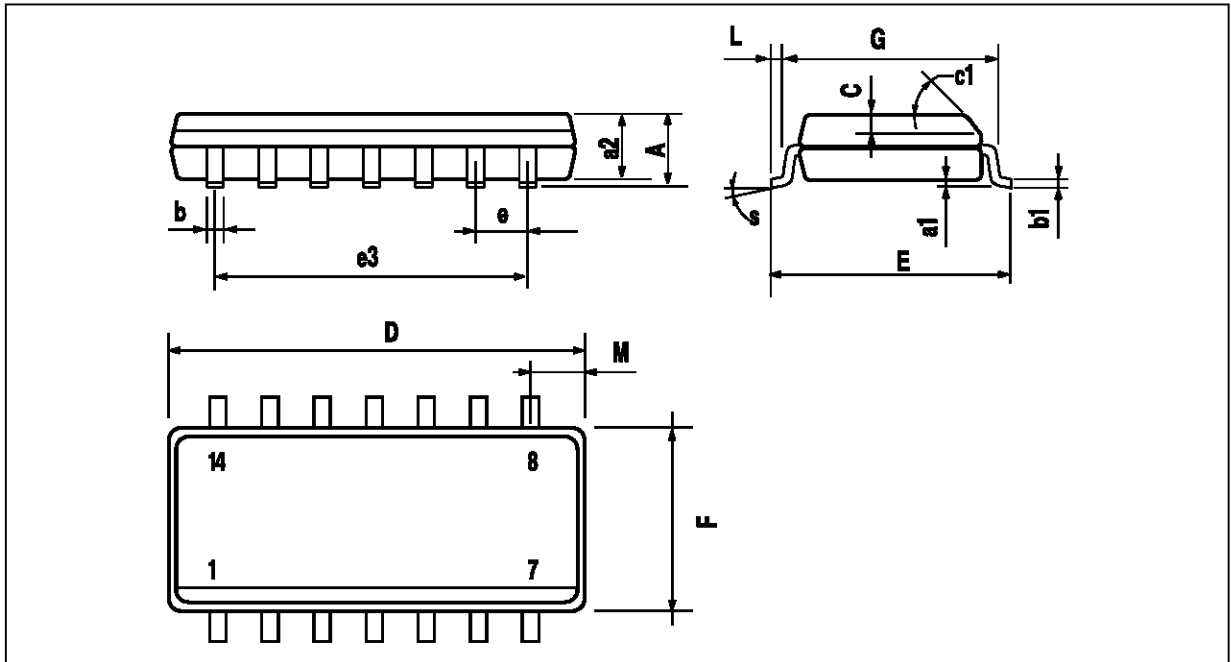

PM-SO14-EFS

Dimensions	Millimeters			Inches		
	Min.	Typ.	Max.	Min.	Typ.	Max.
A			1.75			0.069
a1	0.1		0.2	0.004		0.008
a2			1.6			0.063
b	0.35		0.46	0.014		0.018
b1	0.19		0.25	0.007		0.010
C		0.5			0.020	
c1	45° (typ.)					
D	8.55		8.75	0.336		0.334
E	5.8		6.2	0.228		0.244
e		1.27			0.050	
e3		7.62			0.300	
F	3.8		4.0	0.150		0.157
G	4.6		5.3	0.181		0.208
L	0.5		1.27	0.020		0.050
M			0.68			0.027
S	8° (max.)					

SO14 TEL

Information furnished is believed to be accurate and reliable. However, SGS-THOMSON Microelectronics assumes no responsibility for the consequences of use of such information nor for any infringement of patents or other rights of third parties which may result from its use. No license is granted by implication or otherwise under any patent or patent rights of SGS-THOMSON Microelectronics. Specification mentioned in this publication are subject to change without notice. This publication supersedes and replaces all information previously supplied. SGS-THOMSON Microelectronics products are not authorized for use as critical components in life support devices or systems without express written approval of SGS-THOMSON Microelectronics.

© 1995 SGS-THOMSON Microelectronics – Printed in Italy – All Rights Reserved

SGS-THOMSON Microelectronics GROUP OF COMPANIES
 Australia - Brazil - Canada - China - France - Germany - Hong Kong - Italy - Japan - Korea - Malaysia - Malta - Morocco
 The Netherlands - Singapore - Spain - Sweden - Switzerland - Taiwan - Thailand - United Kingdom - U.S.A.

ORDER CODE: