

# UNR4111/4112/4113/4114/4115/4116/4117/ 4118/4119/4110/411D/411E/411F/411H/411L

## (UN4111/4112/4113/4114/4115/4116/4117/4118/ 4119/4110/411D/411E/411F/411H/411L)

Silicon PNP epitaxial planer transistor

For digital circuits

### Features

- Costs can be reduced through downsizing of the equipment and reduction of the number of parts.
- New S type package, allowing supply with the radial taping.

### Resistance by Part Number

	(R <sub>1</sub> )	(R <sub>2</sub> )
• UNR4111	10kΩ	10kΩ
• UNR4112	22kΩ	22kΩ
• UNR4113	47kΩ	47kΩ
• UNR4114	10kΩ	47kΩ
• UNR4115	10kΩ	—
• UNR4116	4.7kΩ	—
• UNR4117	22kΩ	—
• UNR4118	0.51kΩ	5.1kΩ
• UNR4119	1kΩ	10kΩ
• UNR4110	47kΩ	—
• UNR411D	47kΩ	10kΩ
• UNR411E	47kΩ	22kΩ
• UNR411F	4.7kΩ	10kΩ
• UNR411H	2.2kΩ	10kΩ
• UNR411L	4.7kΩ	4.7kΩ

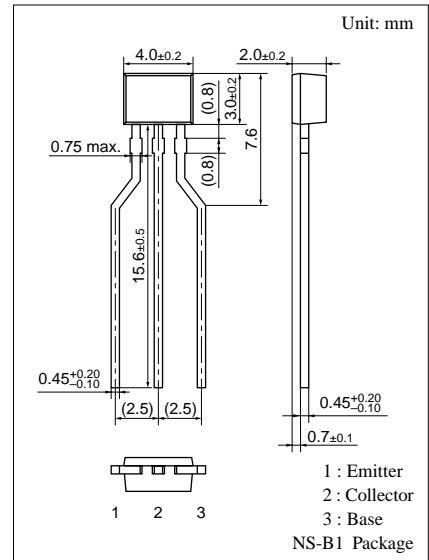

### Internal Connection

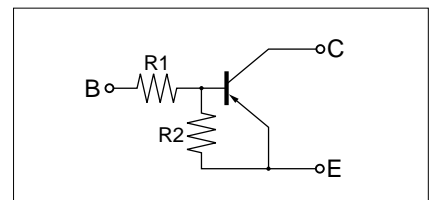

### Absolute Maximum Ratings (T<sub>a</sub>=25°C)

Parameter	Symbol	Ratings	Unit
Collector to base voltage	V <sub>CBO</sub>	-50	V
Collector to emitter voltage	V <sub>CEO</sub>	-50	V
Collector current	I <sub>C</sub>	-100	mA
Total power dissipation	P <sub>T</sub>	300	mW
Junction temperature	T <sub>j</sub>	150	°C
Storage temperature	T <sub>stg</sub>	-55 to +150	°C

Note) The part numbers in the parenthesis show conventional part number.

UNR4111/4112/4113/4114/4115/4116/4117/4118/  
Transistors with built-in Resistor 4119/4110/411D/411E/411F/411H/411L

■ Electrical Characteristics (Ta=25°C)

Parameter		Symbol	Conditions	min	typ	max	Unit	
Collector cutoff current		I <sub>CB0</sub>	V <sub>CB</sub> = -50V, I <sub>E</sub> = 0			-0.1	μA	
		I <sub>CEO</sub>	V <sub>CE</sub> = -50V, I <sub>B</sub> = 0			-0.5	μA	
Emitter cutoff current	UNR4111	I <sub>EBO</sub>	V <sub>EB</sub> = -6V, I <sub>C</sub> = 0			-0.5	mA	
	UNR4112/4114/411E/411D					-0.2		
	UNR4113					-0.1		
	UNR4115/4116/4117/4110					-0.01		
	UNR411F/411H					-1.0		
	UNR4119					-1.5		
	UNR4118/411L					-2.0		
Collector to base voltage		V <sub>CBO</sub>	I <sub>C</sub> = -10μA, I <sub>E</sub> = 0	-50			V	
Collector to emitter voltage		V <sub>CEO</sub>	I <sub>C</sub> = -2mA, I <sub>B</sub> = 0	-50			V	
Forward current transfer ratio	UNR4111	h <sub>FE</sub>	V <sub>CE</sub> = -10V, I <sub>C</sub> = -5mA	35				
	UNR4112/411E			60				
	UNR4113/4114			80				
	UNR4115*/4116*/4117*/4110*			160		460		
	UNR411F/411D/4119/411H			30				
	UNR4118/411L			20				
Collector to emitter saturation voltage		V <sub>CE(sat)</sub>	I <sub>C</sub> = -10mA, I <sub>B</sub> = -0.3mA			-0.25	V	
Output voltage high level		V <sub>OH</sub>	V <sub>CC</sub> = -5V, V <sub>B</sub> = -0.5V, R <sub>L</sub> = 1kΩ	-4.9			V	
Output voltage low level		V <sub>OL</sub>	V <sub>CC</sub> = -5V, V <sub>B</sub> = -2.5V, R <sub>L</sub> = 1kΩ			-0.2	V	
			V <sub>CC</sub> = -5V, V <sub>B</sub> = -3.5V, R <sub>L</sub> = 1kΩ			-0.2		
			V <sub>CC</sub> = -5V, V <sub>B</sub> = -10V, R <sub>L</sub> = 1kΩ			-0.2		
			V <sub>CC</sub> = 5V, V <sub>B</sub> = -6V, R <sub>L</sub> = 1kΩ			-0.2		
Transition frequency		f <sub>T</sub>	V <sub>CB</sub> = -10V, I <sub>E</sub> = 1mA, f = 200MHz		80		MHz	
Input resistance	UNR4111/4114/4115	R <sub>i</sub>		(-30%)		(±30%)	kΩ	
	UNR4112/4117							10
	UNR4113/4110/411D/411E							22
	UNR4116/411F/411L							47
	UNR4118							4.7
	UNR4119							0.51
	UNR411H							1
Resistance ratio	UNR4111/4112/4113/411L	R <sub>1</sub> /R <sub>2</sub>			0.8	1.0	1.2	
	UNR4114				0.17	0.21	0.25	
	UNR4118/4119				0.08	0.1	0.12	
	UNR411D				3.7	4.7	5.7	
	UNR411E				1.7	2.14	2.6	
	UNR411F				0.37	0.47	0.57	
	UNR411H				0.17	0.22	0.27	

\* h<sub>FE</sub> rank classification (UNR4115/4116/4117/4110)

Rank	Q	R	S
h <sub>FE</sub>	160 to 260	210 to 340	290 to 460

Common characteristics chart

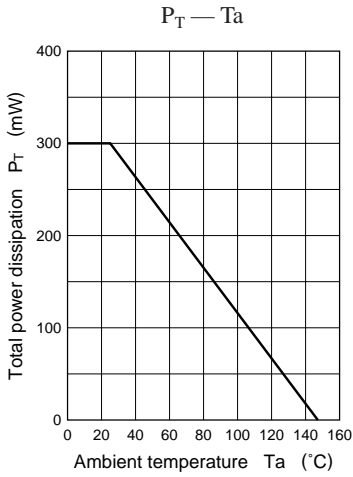

Characteristics charts of UNR4111

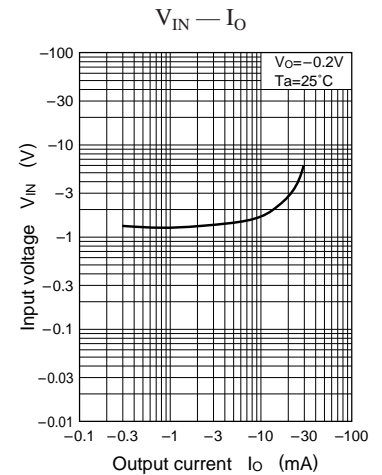
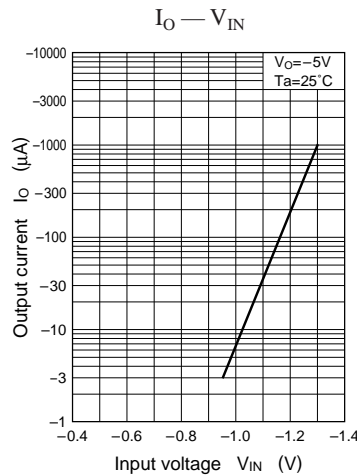
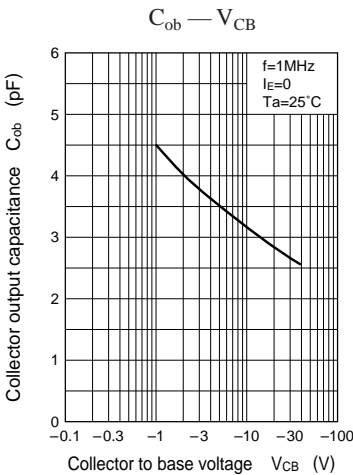
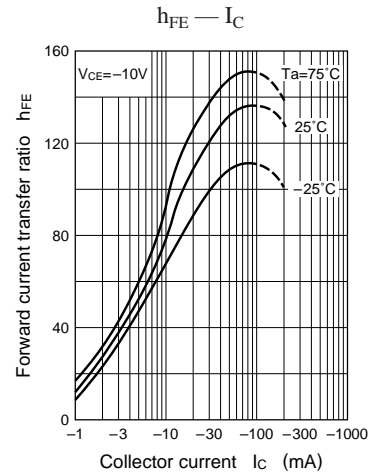
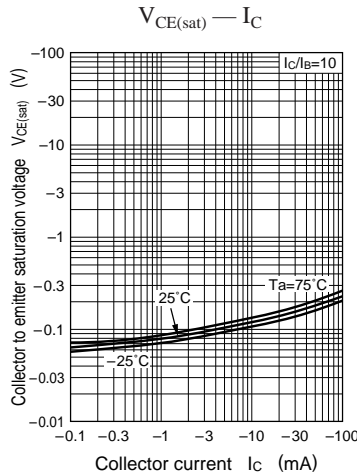
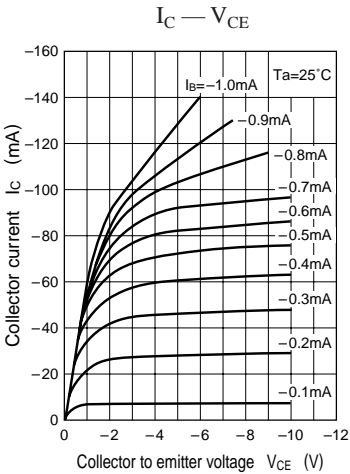

Characteristics charts of UNR4112

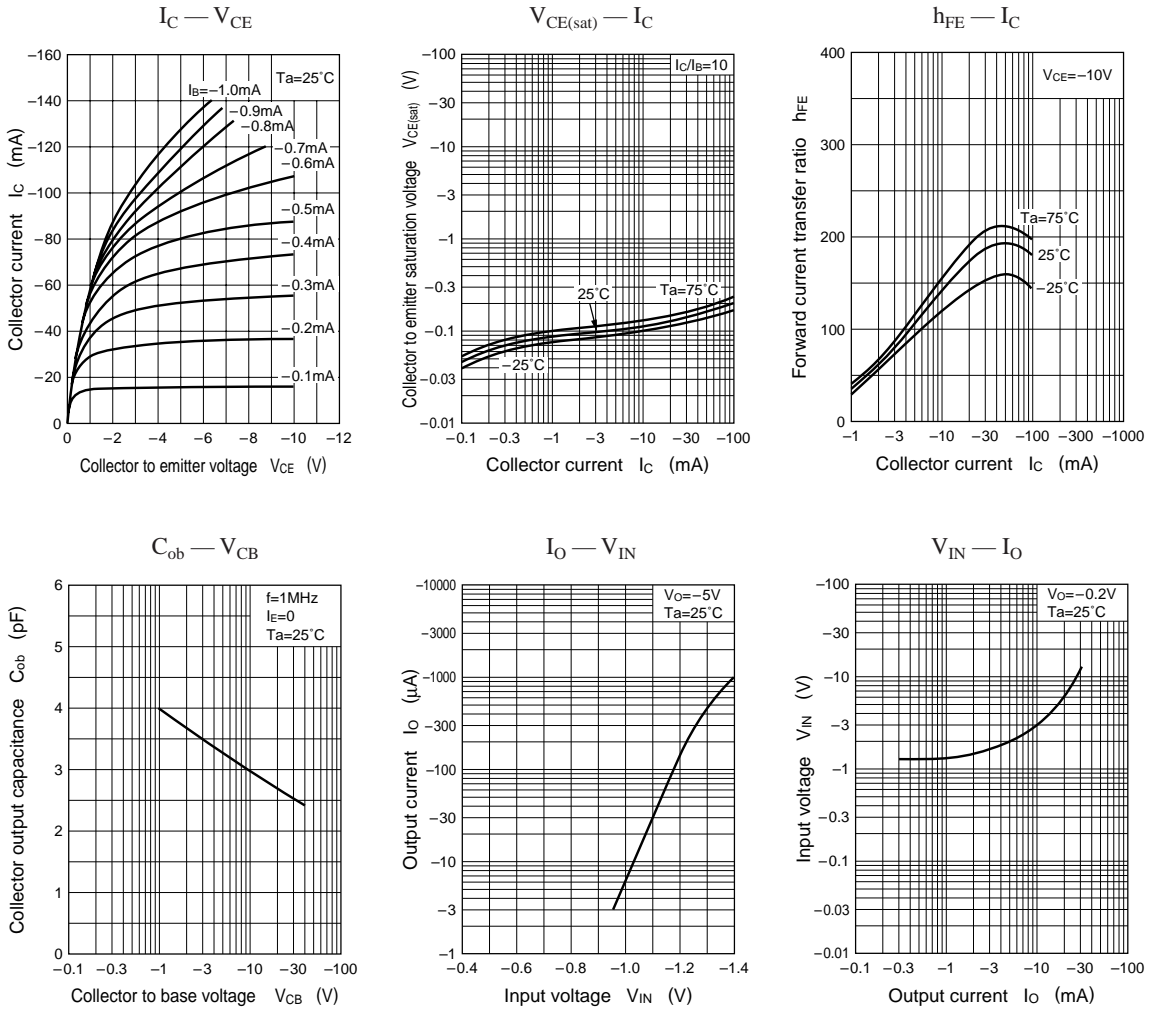

Characteristics charts of UNR4113

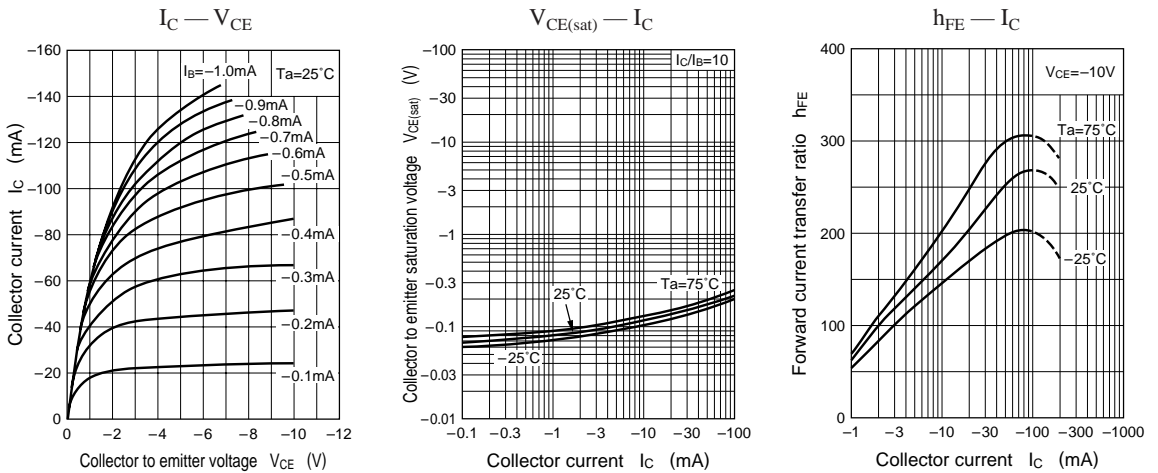

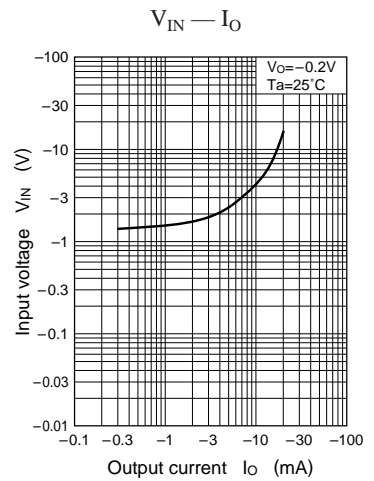
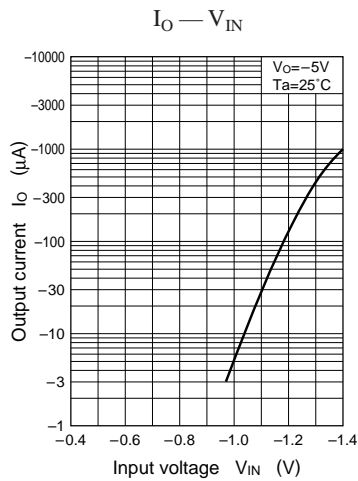
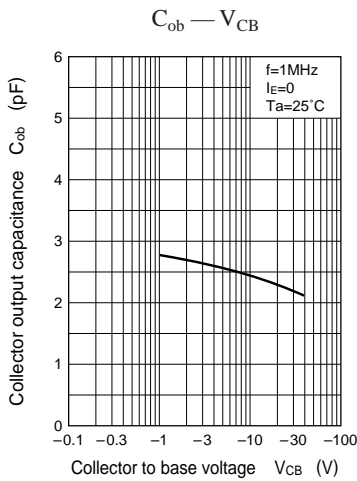

Characteristics charts of UNR4114

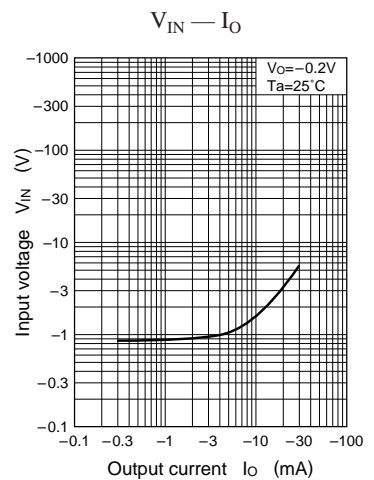
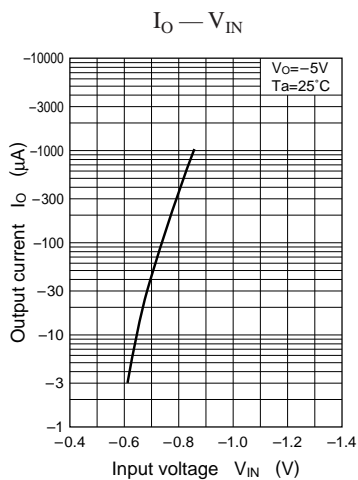
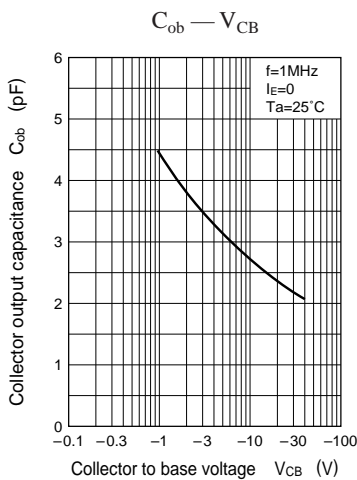
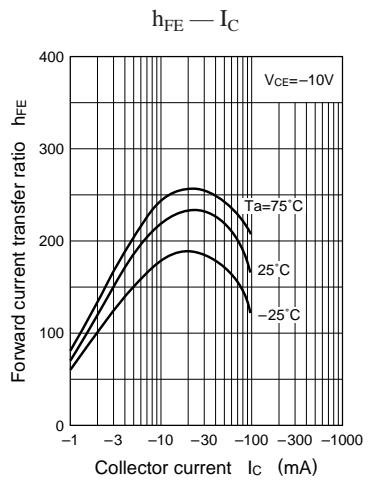
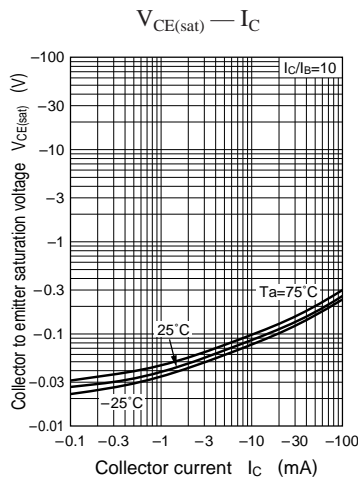
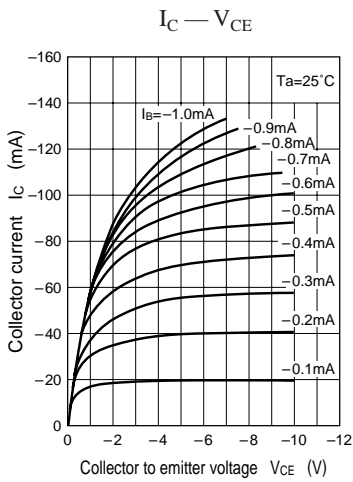

Characteristics charts of UNR4115

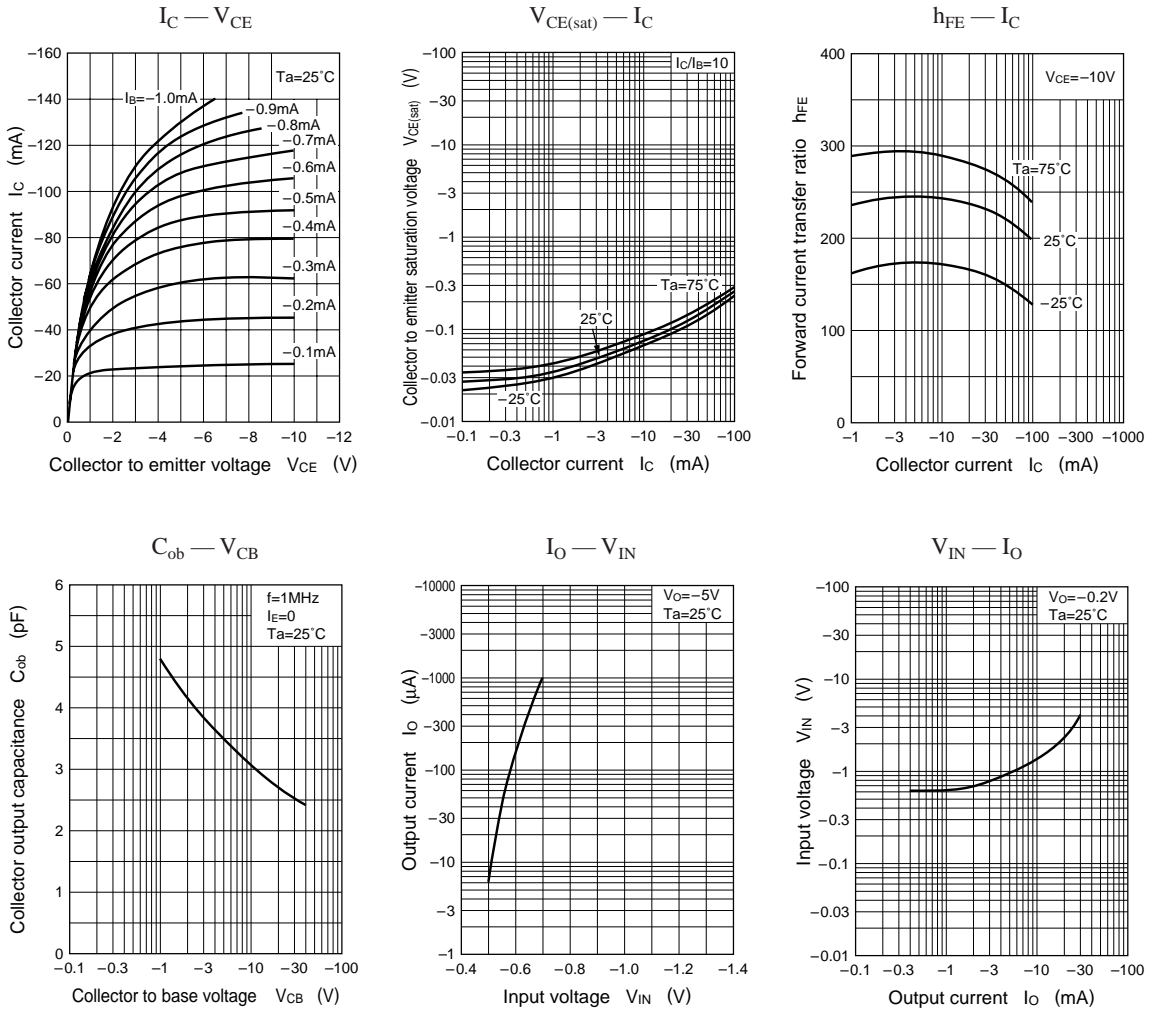

Characteristics charts of UNR4116

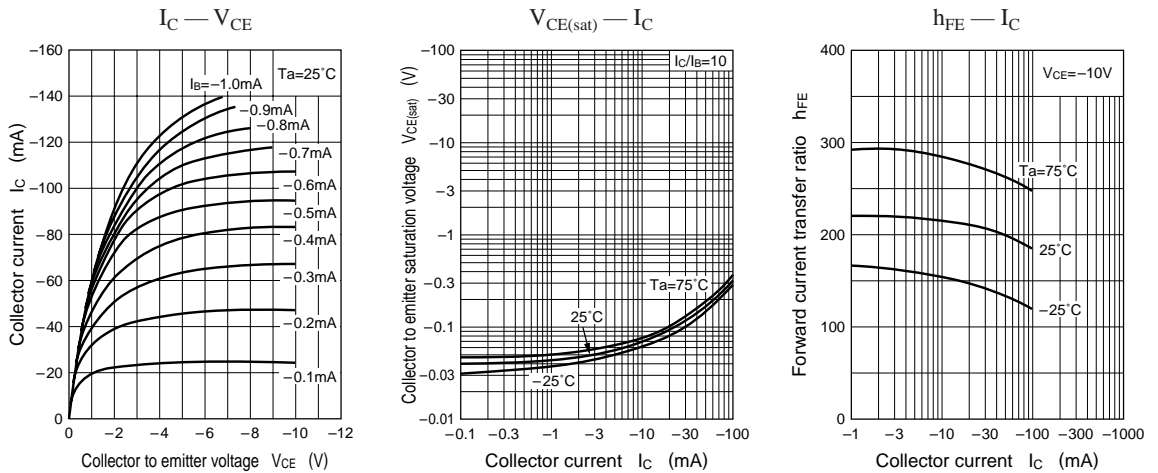

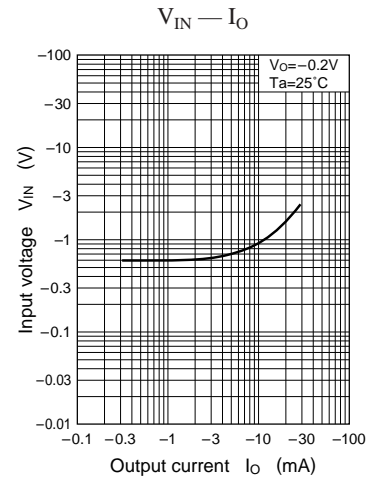
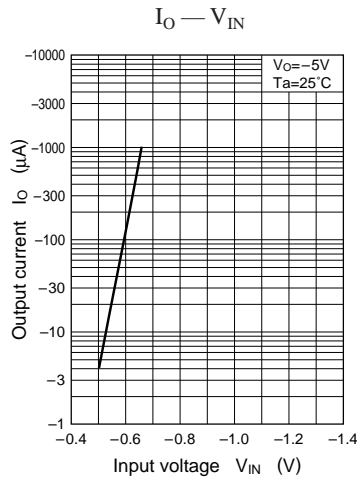
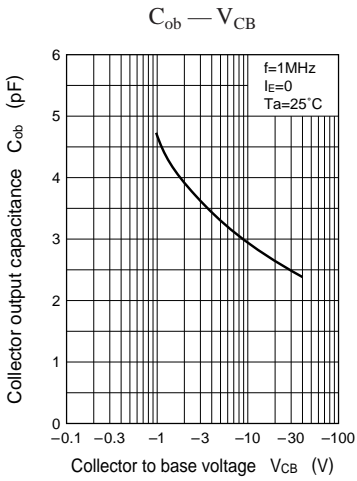

Characteristics charts of UNR4117

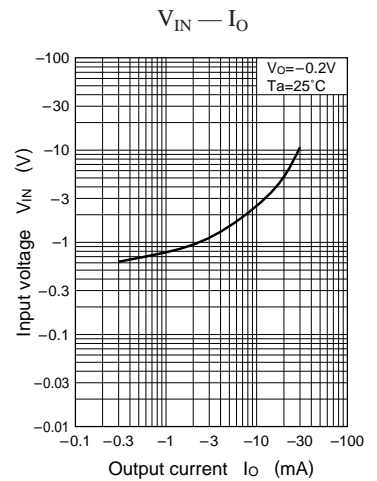
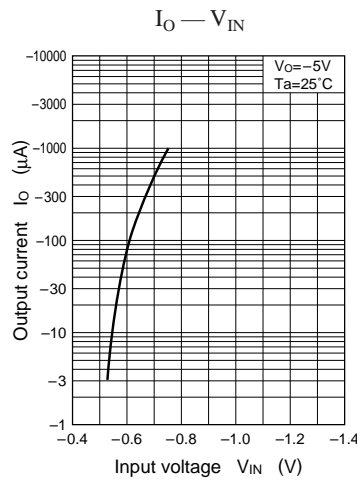
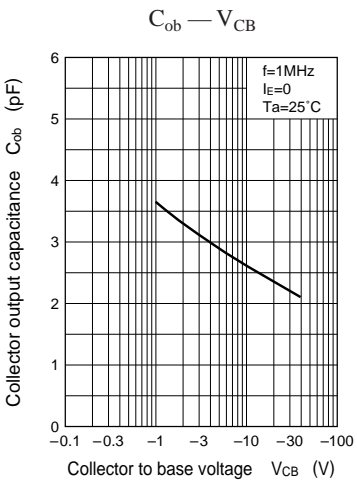
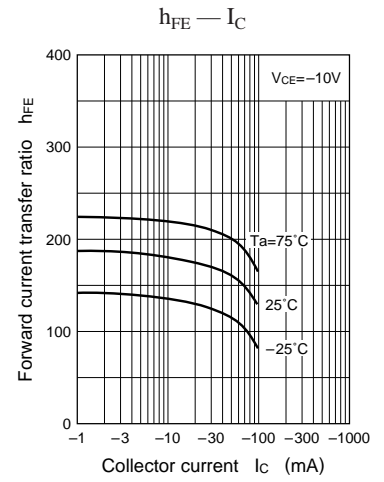
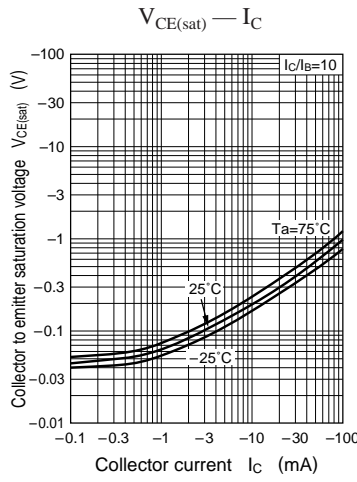
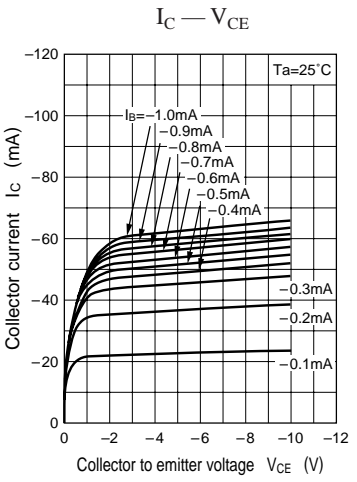

Characteristics charts of UNR4118

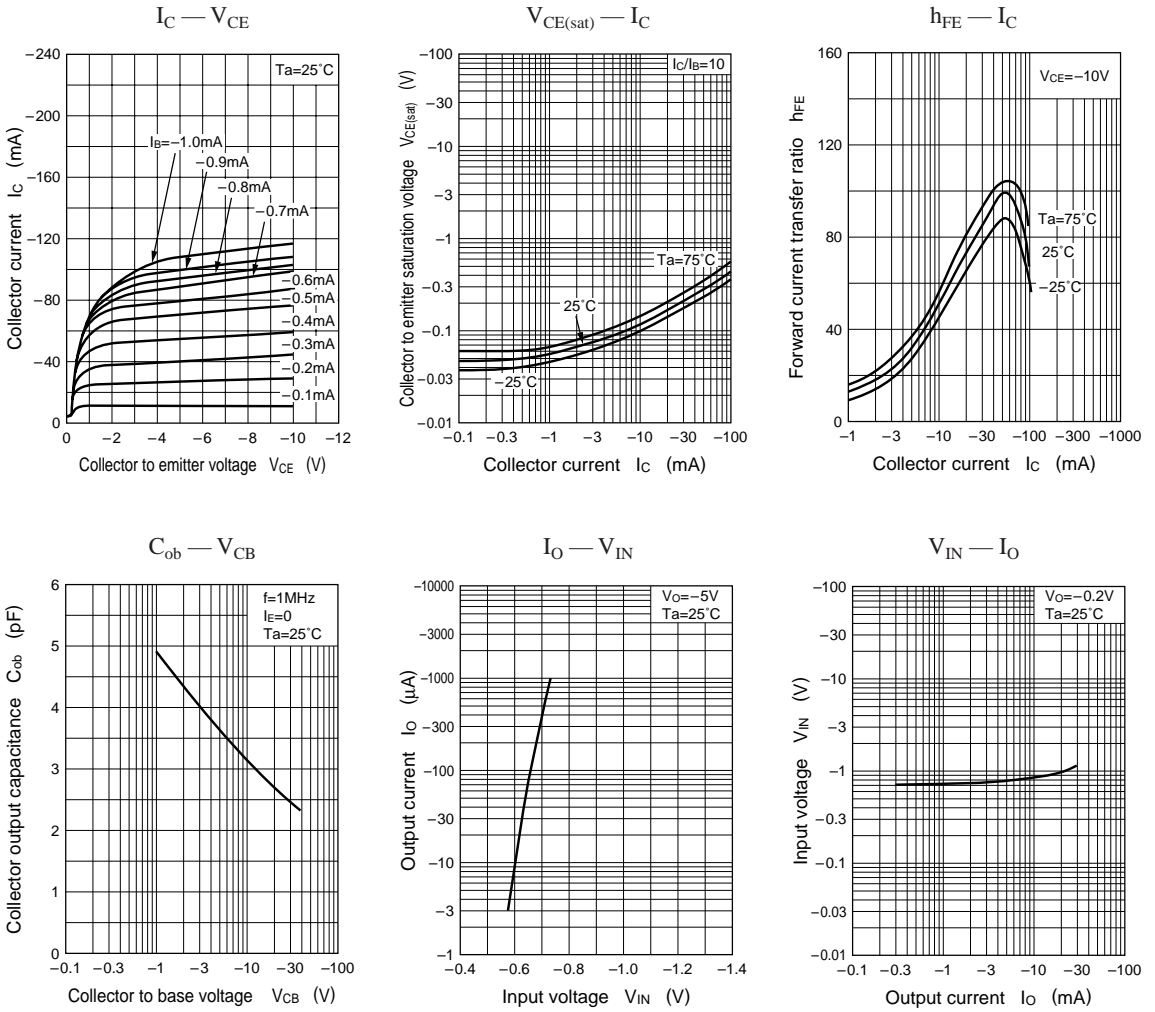

Characteristics charts of UNR4119

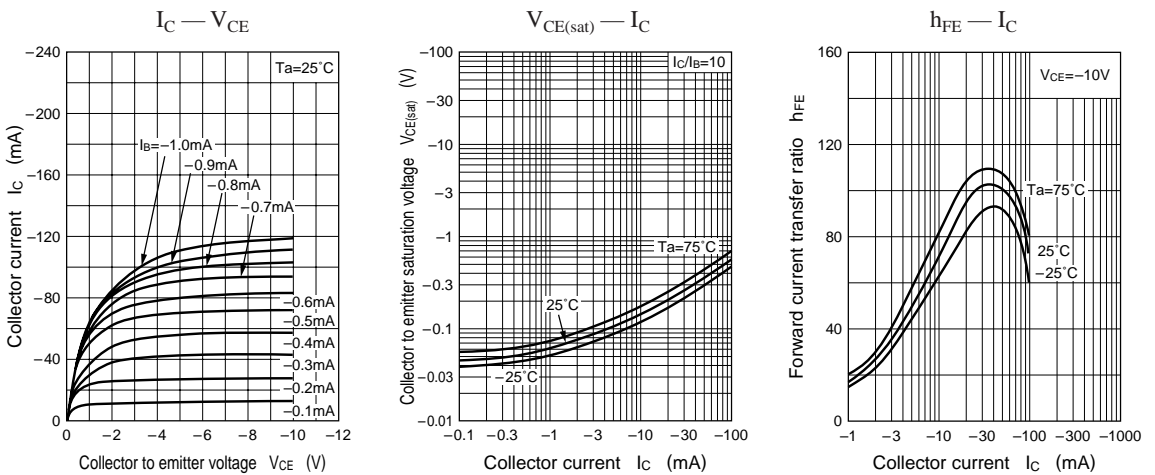

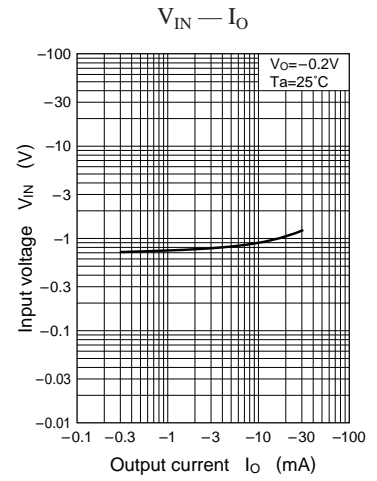
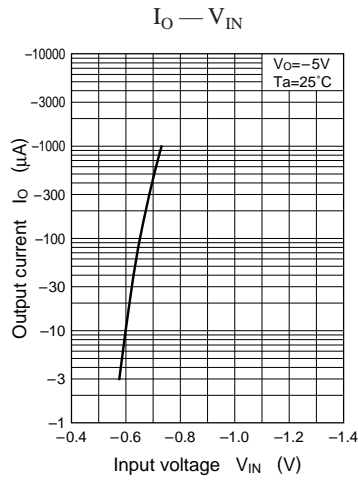
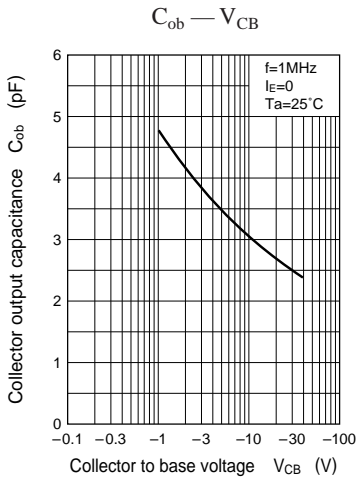

Characteristics charts of UNR4110

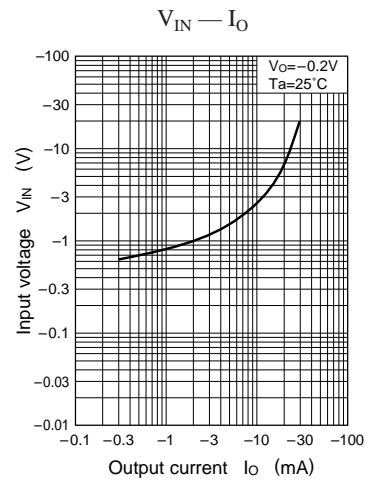
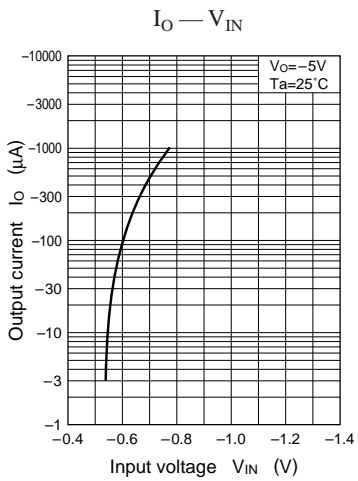
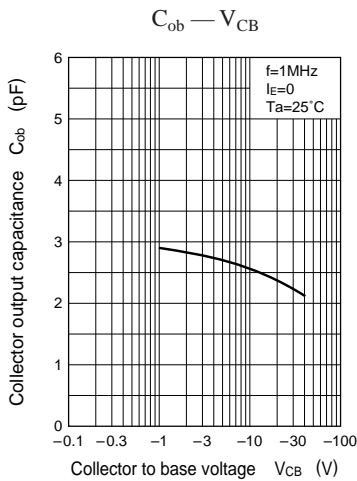
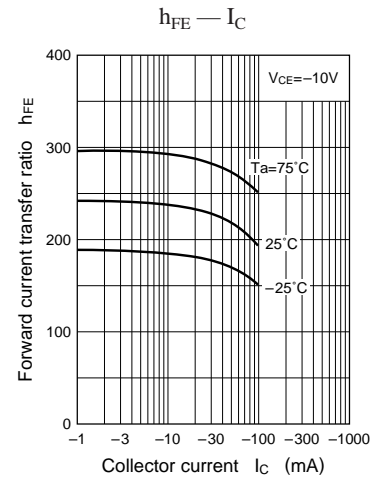
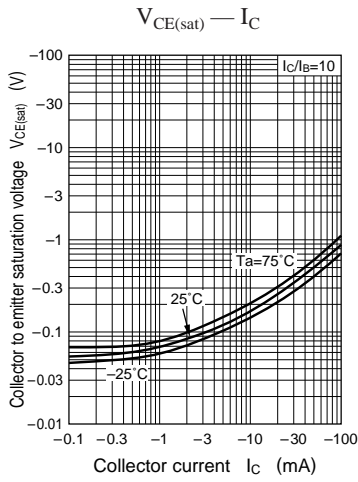
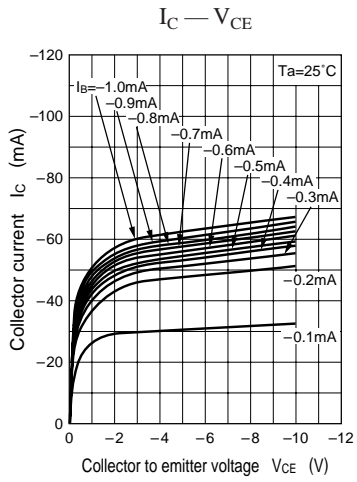

Characteristics charts of UNR411D

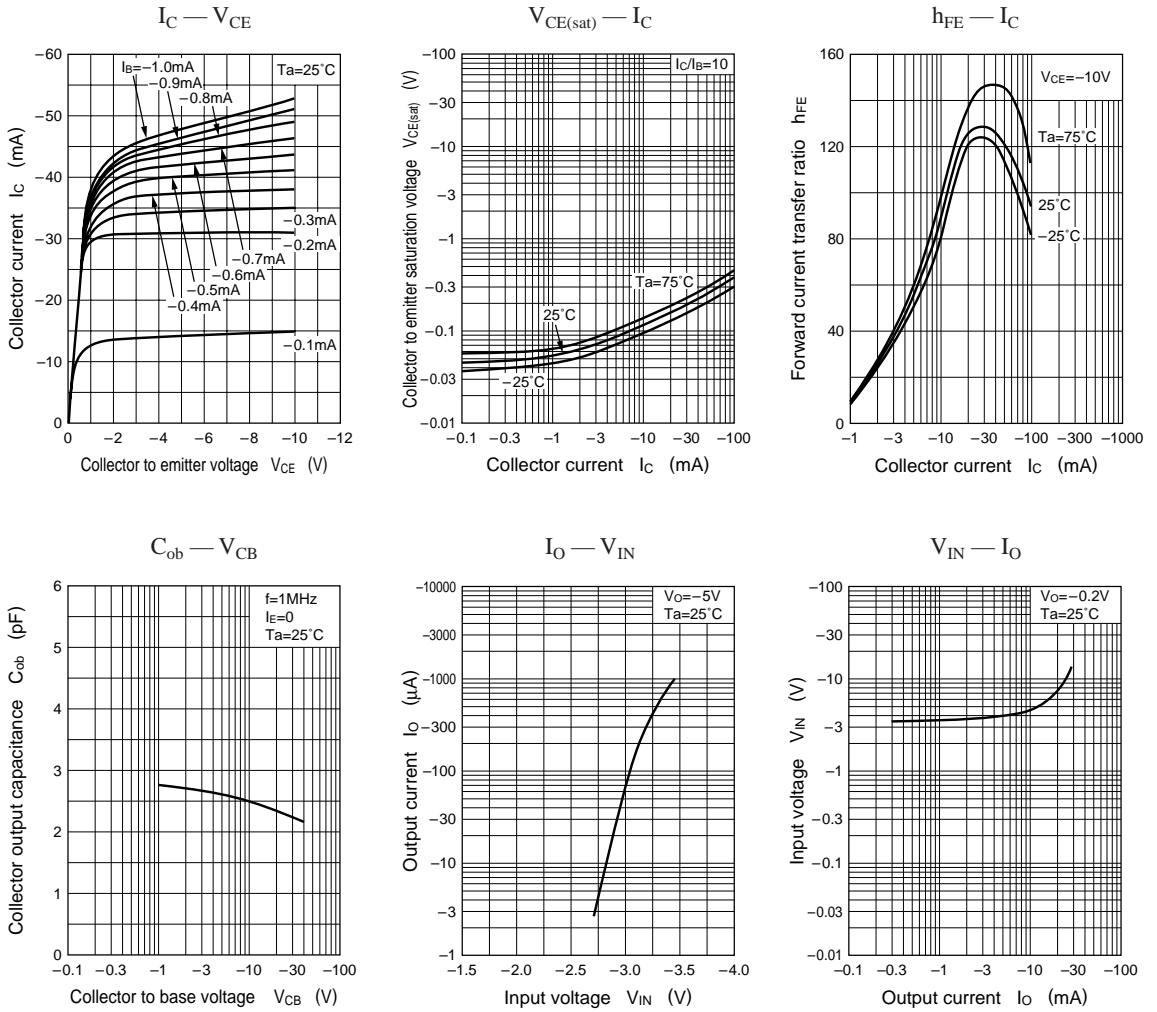

Characteristics charts of UNR411E

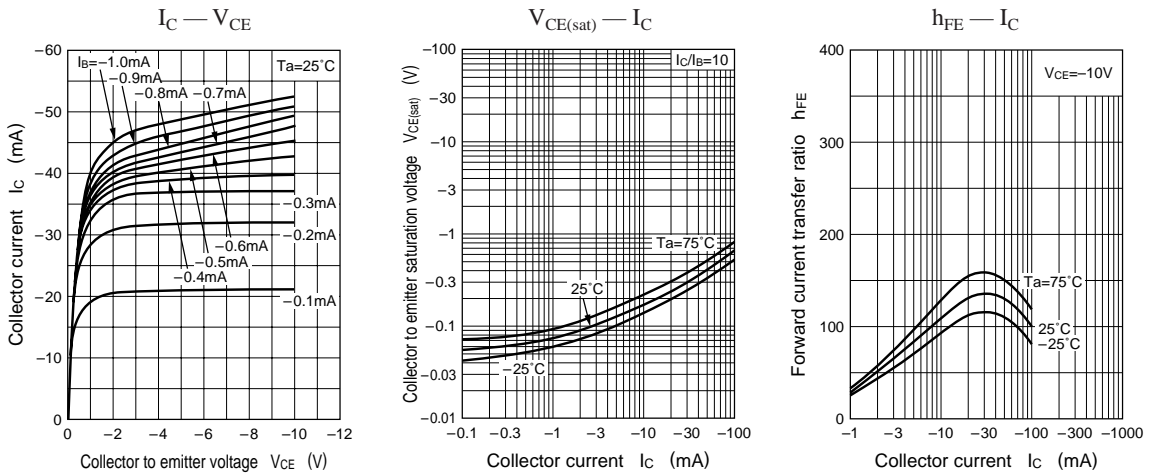

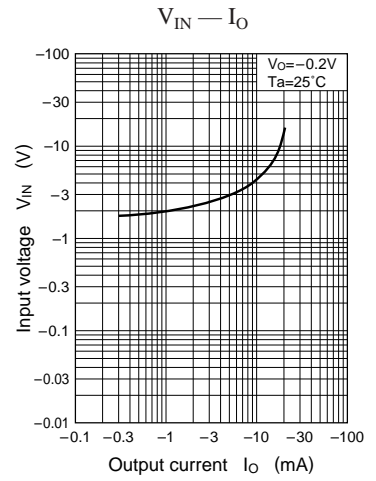
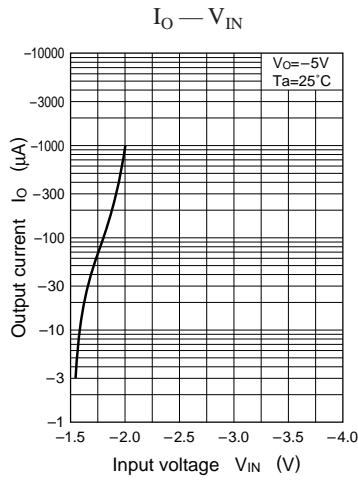
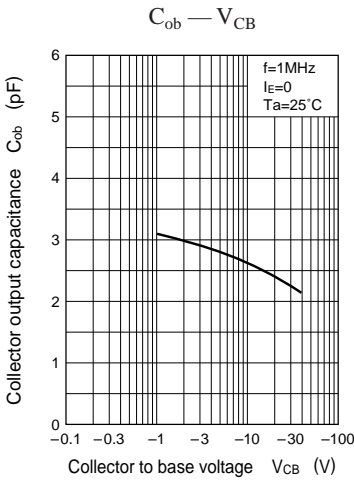

Characteristics charts of UNR411F

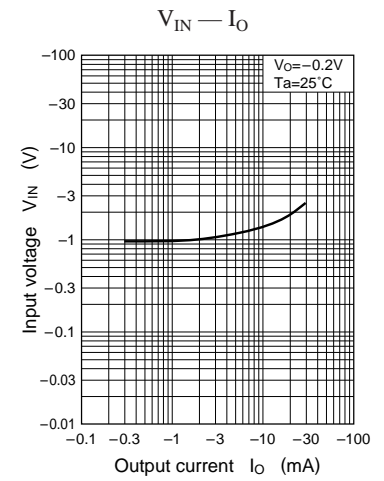
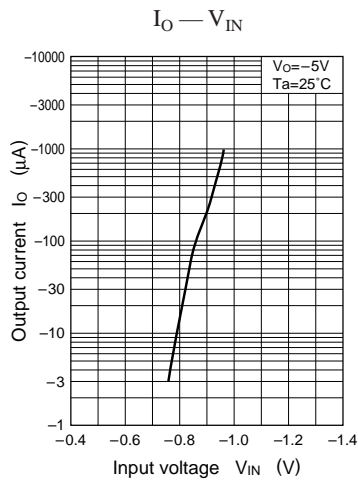
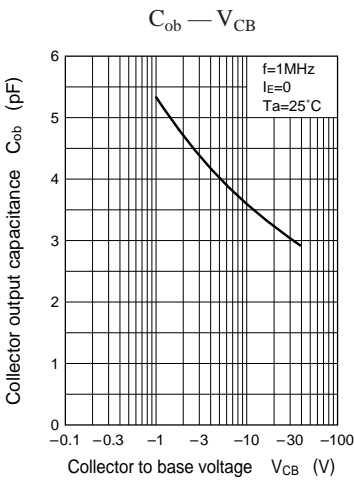
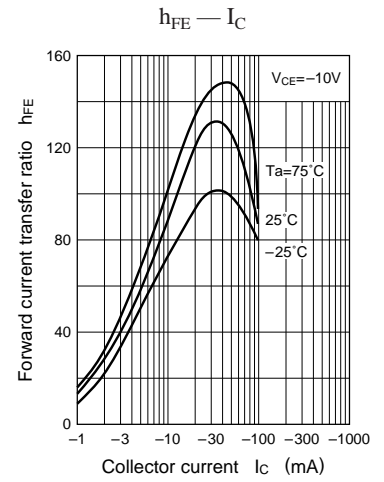
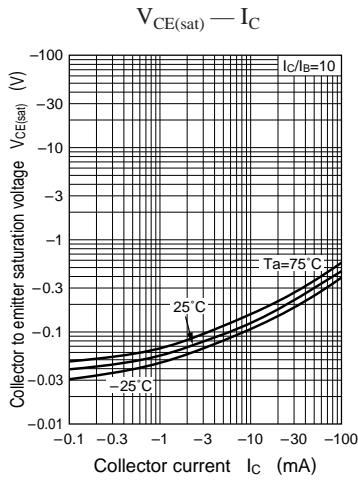
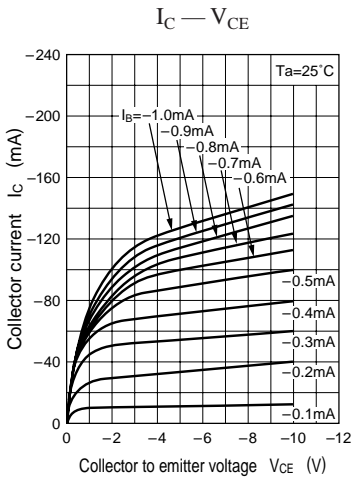

Characteristics charts of UNR411H

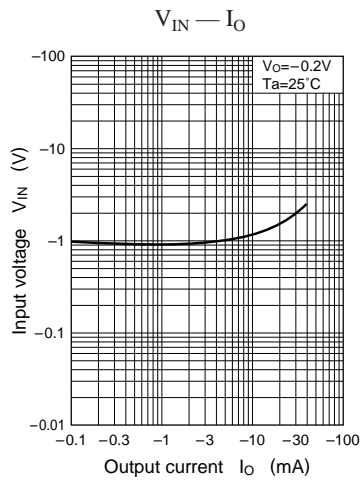
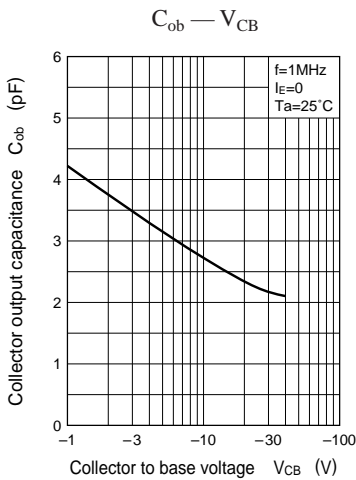
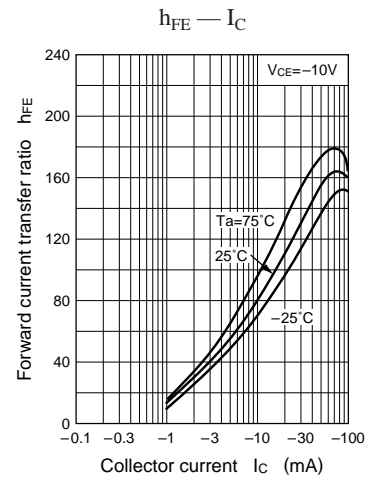
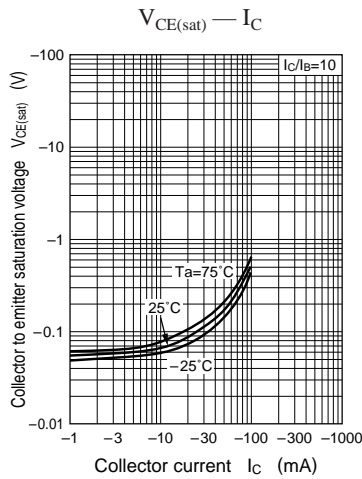
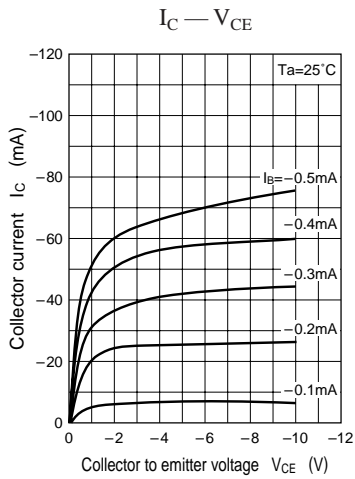

Characteristics charts of UNR411L

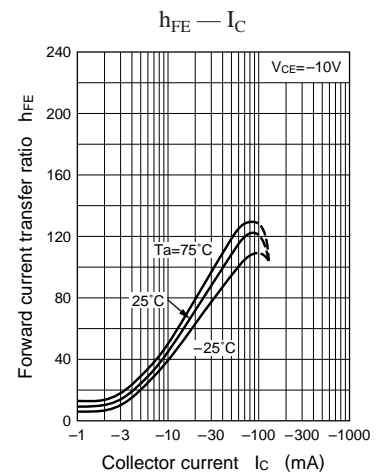
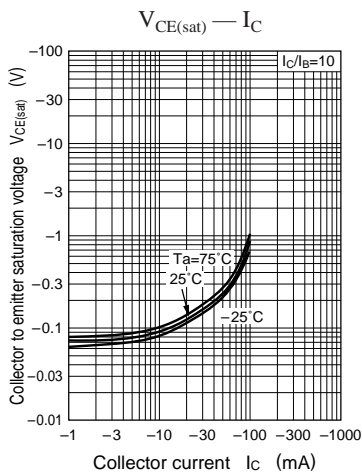
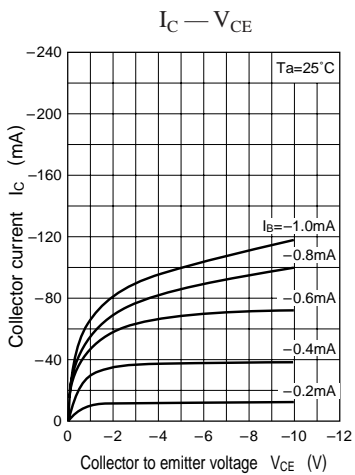

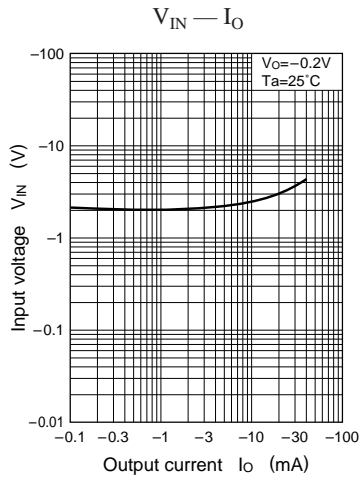
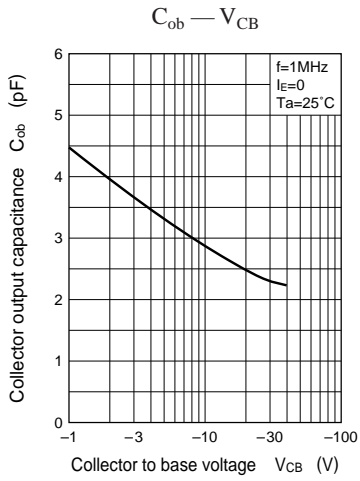

## Request for your special attention and precautions in using the technical information and semiconductors described in this material

- (1) An export permit needs to be obtained from the competent authorities of the Japanese Government if any of the products or technologies described in this material and controlled under the "Foreign Exchange and Foreign Trade Law" is to be exported or taken out of Japan.
- (2) The technical information described in this material is limited to showing representative characteristics and applied circuit examples of the products. It does not constitute the warranting of industrial property, the granting of relative rights, or the granting of any license.
- (3) The products described in this material are intended to be used for standard applications or general electronic equipment (such as office equipment, communications equipment, measuring instruments and household appliances).  
Consult our sales staff in advance for information on the following applications:
  - Special applications (such as for airplanes, aerospace, automobiles, traffic control equipment, combustion equipment, life support systems and safety devices) in which exceptional quality and reliability are required, or if the failure or malfunction of the products may directly jeopardize life or harm the human body.
  - Any applications other than the standard applications intended.
- (4) The products and product specifications described in this material are subject to change without notice for reasons of modification and/or improvement. At the final stage of your design, purchasing, or use of the products, therefore, ask for the most up-to-date Product Standards in advance to make sure that the latest specifications satisfy your requirements.
- (5) When designing your equipment, comply with the guaranteed values, in particular those of maximum rating, the range of operating power supply voltage and heat radiation characteristics. Otherwise, we will not be liable for any defect which may arise later in your equipment.  
Even when the products are used within the guaranteed values, redundant design is recommended, so that such equipment may not violate relevant laws or regulations because of the function of our products.
- (6) When using products for which dry packing is required, observe the conditions (including shelf life and after-unpacking standby time) agreed upon when specification sheets are individually exchanged.
- (7) No part of this material may be reprinted or reproduced by any means without written permission from our company.

## Please read the following notes before using the datasheets

- A. These materials are intended as a reference to assist customers with the selection of Panasonic semiconductor products best suited to their applications.  
Due to modification or other reasons, any information contained in this material, such as available product types, technical data, and so on, is subject to change without notice.  
Customers are advised to contact our semiconductor sales office and obtain the latest information before starting precise technical research and/or purchasing activities.
- B. Panasonic is endeavoring to continually improve the quality and reliability of these materials but there is always the possibility that further rectifications will be required in the future. Therefore, Panasonic will not assume any liability for any damages arising from any errors etc. that may appear in this material.
- C. These materials are solely intended for a customer's individual use.  
Therefore, without the prior written approval of Panasonic, any other use such as reproducing, selling, or distributing this material to a third party, via the Internet or in any other way, is prohibited.