



BIPOLAR ANALOG INTEGRATED CIRCUIT

μ PC1401C

NTSC CHROMINANCE, LUMINANCE, SYNCHRONIZATION, AND DEFLECTION CIRCUIT (CRYSTAL OSCILLATOR TYPE)

μ PC1401C is a bipolar analog integrated circuit designed for NTSC color TV.

It contains video signal processing circuit, chroma signal demodulation circuit, synchronous signal separator, deflection signal – horizontal and vertical – generator and the peripheral circuits in a plastic molded 42 pins dual in-line package.

It makes such adjustments as chroma phase controller, "HORIZONTAL HOLD" and "VERTICAL HOLD" unnecessary.

So, number of components and adjustment man-hour are reduced remarkably.

FEATURES

- Chroma sub-carrier regenerator works using a crystal resonator.
- Deflection original clock signal is generated using a ceramic resonator.
- All of user controls are controlled with DC voltage externally.
- Chroma difference signal output, and built-in Y (intensity of brightness) signal power stage.
- Clear view by the built-in aperture correction circuit.
- Freely programable video DC restration externally.

PACKAGE DIMENSIONS Unit : in millimeters (inches)

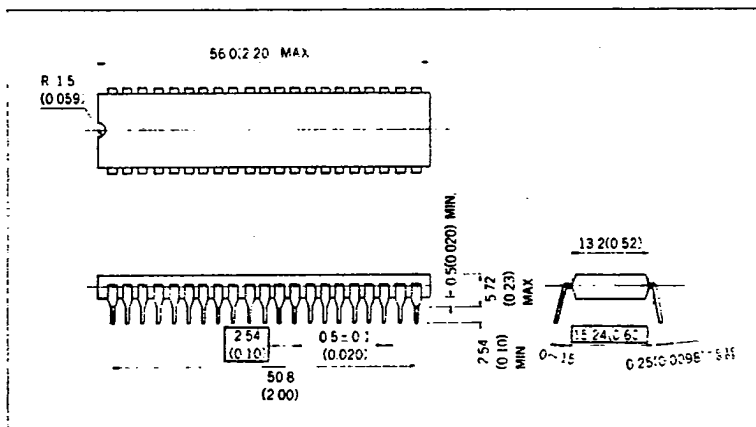

BLOCK DIAGRAM

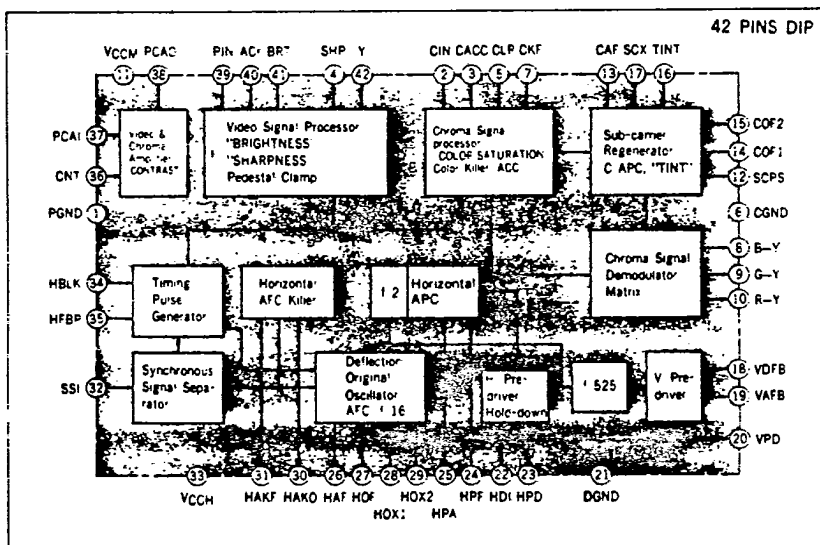

NEC cannot assume any responsibility for any circuits shown or represent that they are free from patent infringement.

NEC Corporation

μPC1401C

NEC ELECTRON DEVICE

TV BLOCK DIAGRAM

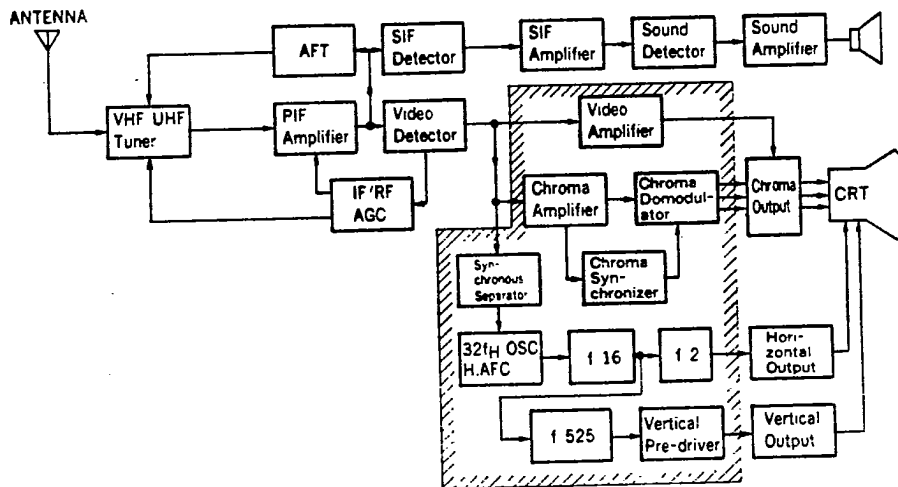

CONNECTION DIAGRAM (Top View)

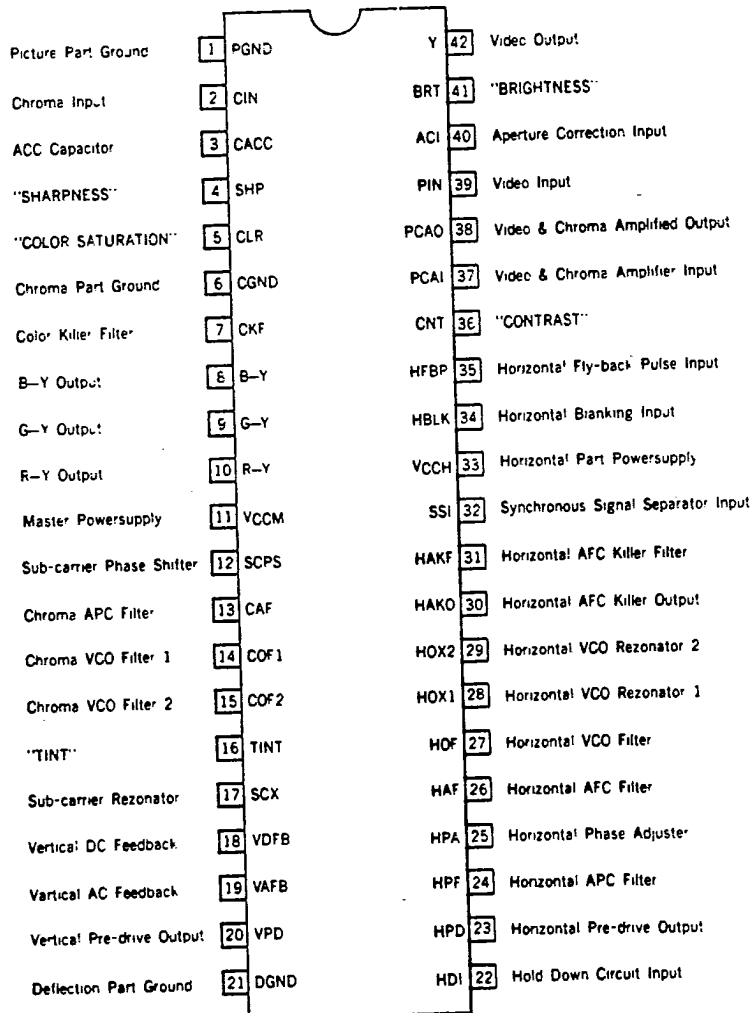

ABSOLUTE MAXIMUM RATINGS ($T_a=25^\circ\text{C}$)

Master Powersupply Voltage	V_{CCM}	13.5	V
Horizontal Powersupply Voltage	V_{CCH}	13.5	V
V & C Amplifier Input Voltage	V_{PCAI}	5.0	V
Chroma Input Voltage	V_{CIN}	5.0	V
Synch. Separator Input Voltage	V_{SSI}	5.0	V
H. Flyback Pulse Input Voltage	V_{HFBP}	V_{CCH}	V
H. Blanking Pulse Input Voltage	V_{HBLK}	V_{CCH}	V
Video Output Current	I_Y	50 ($V_Y < 5.0\text{ V}$)	mA
B-Y, G-Y, R-Y Output Current	$I_{B-Y}, I_{G-Y}, I_{R-Y}$	-10	mA
H. Pre-driver Output Current	I_{HPD}	± 10	mA
V. Pre-driver Output Current	I_{VPD}	-10	mA
Total Power Dissipation	P_D	1.4 ($T_a=60^\circ\text{C}$)	W
Operating Temperature	T_{opt}	-10 to +60	$^\circ\text{C}$
Storage Temperature	T_{stg}	-40 to +150	$^\circ\text{C}$

Mark "-" of current means flow out from the terminal.

RECOMMENDED OPERATING CONDITIONS ($T_a=25^\circ\text{C}$)

Master Power-supply Voltage	V_{CCM}	12 ± 1	V
Horizontal Power-supply Voltage	V_{CCH}	12 ± 1	V
V & C Input Signal Level	e_{PCAI}	1	V_{p-p}
Chroma Input Signal Level	e_{CIN}	200 (Burst Signal)	mV_{p-p}
H. Blanking Pulse Input Voltage	e_{HBLK}	More than 7	V_{p-p}
H. Flyback Pulse Input Voltage	e_{HFBP}	More than 7	V_{p-p}
Video Output Voltage	E_Y	6 (Pedestal Level)	V
"CONTRAST" Control Voltage	V_{CNT}	0 to (4 to 5) to V_{CCM}	V
"BRIGHTNESS" Control Voltage	V_{BRT}	0 to (8 to 9) to V_{CCM}	V
"SHARPNESS" Control Voltage	V_{SHP}	0 to (4 to 5) to V_{CCM}	V
"COLOR SATURATION" Control Voltage	V_{CLR}	V_{CCM} to (5 to 4) to 0	V
"TINT" Control Voltage	V_{TINT}	0 to (4 to 5) to V_{CCM}	V
Hold-down Circuit Input Voltage	V_{HDI}	Trigger level is 0.7	V
H. Pre-driver Output Current	I_{HPD}	± 2	mA

μ PC1401C

NEC ELECTRON DEVICE

ELECTRICAL CHARACTERISTICS ($T_s=25^\circ\text{C}$)

Video & Chroma Part

CHARACTERISTICS	SYMBOL	MIN.	TYP.	MAX.	UNIT	CONDITIONS
Master Powersupply Current	ICCM	42	55	75	mA	$V_{CCM} (=V_{CCH})=12\text{ V}$
B-Y Output Stability Depend On ACC -1	ACC1	-3	0	+3	dB	Burst level at CIN changes from 0 dB (200 mV _{p-p}) to +6 dB (400 mV _{p-p}).
B-Y Output Stability Depend On ACC -2	ACC2	-7	-3	+2	dB	Burst level at CIN changes from 0 dB (200 mV _{p-p}) to -20 dB (20 mV _{p-p}).
Maximum Burst Signal Level Suppressed by Color Killer Function	e_K		-40		dB	0 dB = 200 mV _{p-p} .
Remaining B-Y Signal Under Suppression of Color Killer Function	$e_{B-Y(K)}$			50	mV _{p-p}	Remaining B-Y signal level when burst signal is applied to CIN at e_K level.
Remaining B-Y Signal At Minimum Of "COLOR SATURATION"	$e_{B-Y(CLR)}$			20	mV _{p-p}	Remaining B-Y signal level when CLR voltage is 9 V.
B-Y Signal Distribution In Standard Condition	$e_{B-Y(SC)}$	1.5	2.5	3.6	V _{p-p}	Burst level at CIN is 200 mV _{p-p} . CLR voltage is 7.1 V.
Maximum B-Y Signal Level	$e_{B-Y(MAX)}$	5.0	5.8		V _{p-p}	Burst level at CIN is 200 mV _{p-p} . CLR voltage is 0 V.
Variable Range of B-Y Signal Phase Depend On "TINT" Control Function	$\Delta\theta_{B-Y}$	80	90		deg.	TINT voltage changes from 0 V to V_{CCM} .
B-Y Signal Distribution At Standard "CONTRAST" Control Voltage	$e_{B-Y(CNT)}$	1.4	2.0	2.4	V _{p-p}	Burst level at CIN is 200 mV _{p-p} . Adjust B-Y signal level to 2.5 V _{p-p} with "COLOR SATURATION" control function when CNT voltage is 9V. After it, set CNT voltage to 4.7 V.
Variable Range of B-Y Signal Level Depend On "CONTRAST" Control Function	$\Delta e_{B-Y(CNT)}$	10.5	11.5	12.5	dB	Burst level at CIN is 200 mV _{p-p} . Adjust B-Y signal level to 2.5 V _{p-p} with "CONTRAST" control function when CNT voltage is 9 V. After it, set CNT voltage to 0 V.
Variable Frequency Range of Regenerated Sub-carrier -1	f_{SC1}	400	580	750	kHz	Frequency aberration of SCPS signal from 3 579.545 kHz. CAF voltage is 4.5 V.
Variable Frequency Range of Regenerated Sub-carrier -2	f_{SC2}	-800	-1050	-1300	kHz	Frequency aberration of SCPS signal from 3 579.545 kHz. CAF voltage is 7.5 V.
Peak Voltage of CAF Signal Under Control Of Internal Automatic Sweep Function	V_{PCAF}	7.0	7.2	7.5	V	PCAI input is deflection synchronous signal only. The input level is 300 mV _{p-p} .
Bottom Voltage Of CAS Signal Under Control Of Internal Automatic Sweep Function	V_{BCAF}	4.3	4.6	4.8	V	PCAI input is deflection synchronous signal only. The input level is 300 mV _{p-p} .
Chroma Demodulator Output Ratio -1	R-Y/B-Y	0.68	0.75	0.82	V/V	R-Y level divided by B-Y. CIN input is 200 mV _{p-p} at the burst level, and 400 mV _{p-p} at the coloring ingredient. Frequency of the coloring ingredient is 3.63 MHz.
Chroma Demodulator Output Ratio -2	G-Y/B-Y	0.20	0.25	0.31	V/V	G-Y level divided by B-Y. CIN input is 200 mV _{p-p} at the burst level, and 400 mV _{p-p} at the coloring ingredient. Frequency of the coloring ingredient is 3.63 MHz.

CHARACTERISTICS	SYMBOL	MIN.	TYP.	MAX.	UNIT	CONDITIONS
R-Y Demodulation Angle	$\angle R-Y$	90	98	106	deg.	R-Y vector angle against B-Y vector. Burst level of CIN input is 200 mV _{p-p} .
G-Y Demodulation Angle	$\angle G-Y$	230	240	250	deg.	G-Y vector angle against B-Y vector. Burst level of CIN input is 200 mV _{p-p} .
Demodulator Output DC Voltage Distribution	E_0	6.6	7.1	7.6	V	DC voltage of B-Y, G-Y, and R-Y, when no input to CIN.
Temperature Coefficient Of E_0	$\Delta E_0(T_a)$		0	± 2	mV/°C	Ambient Temperature changes from -10 °C to +60 °C
Non-uniformity of E_0	dE_0		0	± 200	mV	DC voltage difference among B-Y, G-Y, and R-Y, at tracing time.
Supply Voltage Dependence of dE_0	$\Delta dE_0(V_{CCM})$		0	50	mV	V_{CCM} changes from 11 V to 13 V. $V_{CCH}=V_{CCM}$
Temperature Coefficient of dE_0	$\Delta dE_0(T_a)$		0	+1	mV/°C	Ambient Temperature changes from -10 °C to +60 °C
Remaining Carrier Wave Level Of Demodulator Output	e_{carry}		60	120	mV	Remaining sub-carrier wave level of B-Y, G-Y, and R-Y in tracing time (Contains harmonic over-tone ingredient), when no input to CIN.
Harmonic Over-tone Of Demodulator Output	e_{hot}		0.6	1.0	V _{p-p}	Harmonic over-tone level of B-Y, G-Y, and R-Y (Contains remaining sub-carrier) Burst signal level of CIN input is 200 mV _{p-p} .
Maximum Voltage Gain Of Video & Chroma Amplifier	APCA	6.0	7.0	9.0	dB	PCAO signal level comparing with PCAI Input. The PCAI input is shown by Fig. 2 in page 8. CNT voltage is 9 V.
PCAO Signal Distribution At Standard "CONTRAST" Control Voltage	$e_{PCAO}(CNT)$	1.3	1.8	2.3	V _{p-p}	PCAO output level, when CNT voltage is 4.7 V. PCAI Input is shown by Fig. 2 in page 8.
Variable Range Of PCAO Output Depend On "CONTRAST" Control Function	$\Delta e_{PCAO}(CNT)$	11	12	13	dB	Variable Range of PCAO output level when CNT voltage is changed from 0 V to 9 V. PCAI input is shown by Fig. 2 in page 8.
Frequency Response Of Video & Chroma Amplifier	FRPCA	-3	0		dB	Gain inconstancy when PCAI input signal frequency changes from 200 kHz to 4.2 MHz. PCAI input signal is shown by Fig. 1 in page 8.
Voltage Gain Of Video Signal Processor	APSP	10	12	14	dB	Y output level comparing with PIN input signal. PCAI input signal is shown by Fig. 1 in page 8. The input signal frequency is 200 kHz.
"BRIGHTNESS" Control Voltage Distribution for Standard Y Output Level	V_{BRT}	7.9	8.2	8.5	V	Applied BRT voltage when black level of Y output is controlled to 6 V. PCAI input is 300 mV _{p-p} deflection synchronous signal only.
Y Black Level At a BRT Voltage -1	$V_{Y(BRT)1}$	6.0	7.0		V	Black level of Y output when BRT voltage is 7.5 V. PCAI input is 300 mV _{p-p} deflection synchronous signal only.
Y Black Level At a BRT Voltage -2	$V_{Y(BRT)2}$		1.5	2.0	V	Black level of Y output when BRT voltage is 9.5 V. PCAI input is 300 mV _{p-p} deflection synchronous signal only.

μPC1401C

NEC ELECTRON DEVICE

CHARACTERISTICS	SYMBOL	MIN.	TYP.	MAX.	UNIT	CONDITIONS
Frequency Response Of Video Signal Processor Depend On "SHARPNESS" Control Function -1	FR _{Y(SHP)1}	-5.5	-3.5	-1.5	dB	Difference of gain for 2 MHz signal against one for 200 kHz signal, when SHP voltage is 9 V. PCAI input is shown by Fig. 1 in page 8.
Frequency Response Of Video Signal Processor Depend On "SHARPNESS" Control Function -2	FR _{Y(SHP)2}	+6.0	+9.0	+12	dB	Difference of gain for 2 MHz signal against one for 200 kHz signal, when SHP voltage is 0 V. PCAI input is shown by Fig. 1 in page 8.
Null Point Of "SHARPNESS" Control Voltage	V _{NSHP}	4.6	4.9	5.2	V	SHP voltage is adjusted as frequency response of video signal processor is constant for signal from 200 kHz to 2.0 MHz. PCAI Input is shown by Fig. 1 in page 8.
Temperature Coefficient Of Y Black Level	ΔV _{Y(T_a)}	0	+2.5	+5.0	mV/°C	Temperature Coefficient of black level of Y output when ambient temperature changes from -10 °C to +60 °C. Black level of Y output is set to 6 V at 25 °C.

Synchronization & Deflection Part

CHARACTERISTICS	SYMBOL	MIN.	TYP.	MAX.	UNIT	CONDITIONS	
Horizontal Part Powersupply Current	I _{CCH}	8	12	16	mA	V _{CCH} (=V _{CCM})=12 V	
Synchronous Signal Separator Input DC Voltage	E _{SSI}	7.3	7.6	7.9	V	SSI terminal DC voltage with no input.	
Vertical Free-running Frequency -1	f _{vo1}		f _H /296		Hz	Frequency ratio of VDFB terminal signal against HPD output, when SSI voltage is set to V _{CCM} .	
Vertical Free-running Frequency -2	f _{vo2}		f _H /232		Hz	Frequency ratio of VDFB terminal signal against HPD output, when SSI voltage is set to 0 V.	
Lowest VDFB Input Voltage Interrupting VPD Pulse	V _{LVDFB}	3.7	4.0	4.3	V	Lowest VDFB voltage with which VFD output is disappeared.	
Vertical Blanking Pulse Width	PW _{VBLK}	See Fig. 3 in page 8					Watch blanking time length of Y output. PCAI input is 300 mV _{p-p} deflection synchronous signal only.
VPD Output Pulse Width	PW _{VPD}	See Fig. 3 in page 8					Watch VPD output pulse width. PCAI input is 300 mV _{p-p} deflection synchronous signal only.
Voltage Gain Distribution Of Vertical Pre-driver	A _{VPD}	4.5	6.0	7.5	V/V	Change of VPD output comparing with change of VAFB input when VAFB DC voltage is changed from 3.5 V to 3.7 V.	
Lowest V _{CCM} Available To Vertical Frequency Divider	V _{LCCM(VO)}		3.3	4.0	V	Lowest V _{CCM} with which VDFB pulse appears. PCAI input is 300 mV _{p-p} deflection synchronous signal only.	
Lowest V _{CCM} Available To Vertical Synchronizer	V _{LCCM(VS)}		4.1	5.0	V	Lowest V _{CCM} with which VDFB terminal signal synchronizes with synchronous signal of PCAI input. The input is 300 mV _{p-p} deflection synchronous signal only.	
Horizontal Free-running Frequency	f _{HO}	-50	0	+50	Hz	Frequency aberration of HPD output from 15.734 kHz.	

CHARACTERISTICS	SYMBOL	MIN.	TYP.	MAX.	UNIT	CONDITIONS
Supply Voltage Dependence Of f_{HO} -1	$\Delta f_{HO}(V_{CCH}1)$		± 5	± 20	Hz	Frequency change of HPD output when V_{CCH} is changed from 11 V to 13 V. $V_{CCM}=V_{CCH}$. Compare with HPD output frequency at V_{CCH} is 12 V.
Supply Voltage Dependence Of f_{HO} -2	$\Delta f_{HO}(V_{CCH}2)$	0	-40	-100	Hz	Frequency change of HPD output at V_{CCH} is 7.0 V comparing with frequency at V_{CCH} is 12 V. $V_{CCM}=V_{CCH}$
Drift Of f_{HO} Depend On Ambient Temperature	$\Delta f_{HO}(T_a)$			± 20	Hz	Frequency drift of HPD output when ambient temperature changes from -10°C to $+60^\circ\text{C}$. Compare with the frequency at ambient temperature is 25°C .
Horizontal Synchronous Capture Range	f_{HC}	± 500	± 600		Hz	Farthest frequency of synchronous signal of PCA1 input which can be captured by horizontal AFC function. PCA1 input is 300 mV _{p-p} variable frequency horizontal synchronous signal only. PCA1 input pulse width is 4.8 μs .
Horizontal Pre-driver Output Pulse Width	PW _{HPD}	19	21	23	μs	High level time of HPD output. PCA1 input is 300 mV _{p-p} deflection synchronous signal only.
Phase Change Of HPD Output Depend On Frequency Of Synchronous Signal	$\Delta\phi_H$		2	3	$\mu\text{s}/600\text{ Hz}$	Watch phase change of HPD output comparing with PCA1 input when synchronous signal frequency of PCA1 changes from 15.434 kHz to 16.034 kHz.
Lowest V_{CCH} Available To Horizontal Part	V_{LCCH}		4.0	5.0	V	Lowest V_{CCH} with which HPD output appears. PCA1 input is 300 mV _{p-p} deflection synchronous signal only.
Maximum Deflection Synchronous Signal Level Triggering Horizontal AFC Killer	$\epsilon_{PCA1}(HAK)$	-14	-10	-6	dB	Maximum synchronous signal level of PCA1 input with which HAKO terminal voltage keeps above 1.0 V. PCA1 input is deflection synchronous signal only. 0 dB = 250 mV _{p-p} .
Lowest Triggering Voltage Of HDI Input	E _{HDI}	580	640	700	mV	Lowest HDI input voltage with which HPD output is disappeared.
Lowest V_{CCH} Keeping Hold Down Work	$V_{CCH}(HD)$			3.0	V	After trigger hold down circuit, lowest V_{CCH} with which hold down circuit can keep the work.

Fig. 1 TEST SIGNAL OF FR_{PCA}, APSP, FRY(SHP)1, FRY(SHP)2, AND V_{NSHP}

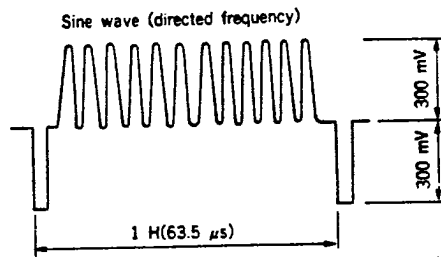

Fig. 2 TEST SIGNAL OF A_{PCA}, e_{PCAO}(CNT), AND Δ e_{PCAO}(CNT)

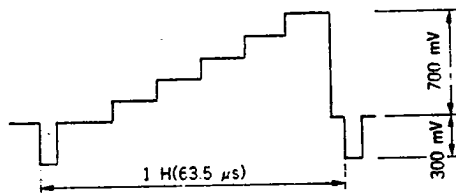
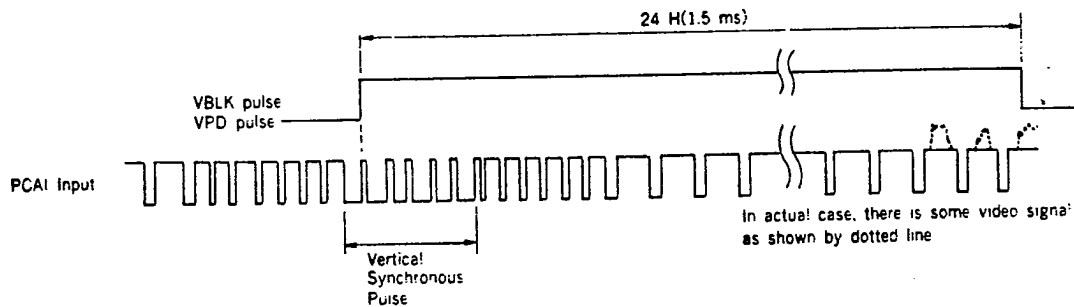

Fig. 3 SIGNAL TIMING OF PW_{VBLK}, AND PW_{VPD}



TEST CIRCUIT

