

BIPOLAR ANALOG INTEGRATED CIRCUITS

μ PC78M00A SERIES

THREE TERMINAL POSITIVE VOLTAGE REGULATORS

DESCRIPTION

μ PC78M00A series are monolithic three terminal positive regulators which employ internally current limiting, thermal shut down, output transistor safe operating area protection make them essentially indestructible.

They are improved for load regulation, as comparison of conventional μ PC78M00 series.

FEATURES

- Wide operation temperature range.
- Good regulation (line, load).
- Built-in some protection circuits.
(over current protection, SOA protection and thermal shut down)

ORDER INFORMATION

TYPE NUMBER	OUTPUT VOLTAGE	PACKAGE	QUALITY GRADE
μ PC78M05AHF	5 V	MP-45G (ISOLATED TO-220)	Standard
μ PC78M06AHF	6 V		
μ PC78M07AHF	7 V		
μ PC78M08AHF	8 V		
μ PC78M09AHF	9 V		
μ PC78M10AHF	10 V		
μ PC78M12AHF	12 V		
μ PC78M15AHF	15 V		
μ PC78M18AHF	18 V		
μ PC78M24AHF	24 V		

Please refer to "Quality grade on NEC Semiconductor Devices" (Document number IEI-1209) published by NEC Corporation to know the specification of quality grade on the devices and its recommended applications.

EQUIVALENT CIRCUIT

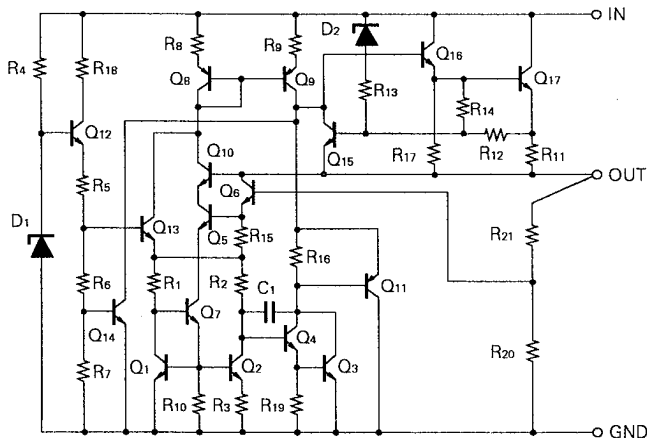

CONNECTION DIAGRAM

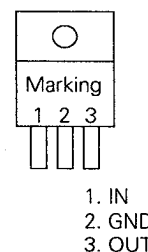

ABSOLUTE MAXIMUM RATINGS (T_a = 25 °C)

CHARACTERISTIC	SYMBOL	RATING	UNIT
Input Voltage	V _{IN}	35/40 (Note1)	V
Internal Power Dissipation	P _T	15 (Note2)	W
Operating Ambient Temperature Range	T _{opt}	- 30 to + 85	°C
Operating Junction Temperature Range	T _{opt(j)}	- 30 to + 150	°C
Storage Temperature Range	T _{stg}	- 55 to + 150	°C
Thermal Resistance (junction to case)	R _{th(j-c)}	7	°C/W
Thermal Resistance (junction to ambient)	R _{th(j-a)}	65	°C/W

(Note1) μPC78M05A, 06, 07, 08, 09, 10, 12, 15, 18 : 35 V, μPC78M24A : 40 V

(Note2) Internally limited

TYPICAL CONNECTION

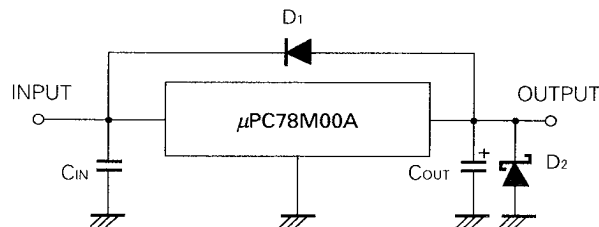

C1: Required if regulator is located an appreciable distance from power supply filter.

C2: More than 0.1 μF

D1: Needed for V_{IN} < V_o

D2: Needed for V_o < GND

RECOMMENDED OPERATING CONDITIONS

CHARACTERISTIC	SYMBOL		MIN.	TYP.	MAX.	UNIT
Input Voltage	V _{IN}	μPC78M05AHF	7	10	25	V
		μPC78M06AHF	8.5	11	25	
		μPC78M07AHF	9.5	12	25	
		μPC78M08AHF	10.5	14	25	
		μPC78M09AHF	11.5	15	25	
		μPC78M10AHF	12.5	17	28	
		μPC78M12AHF	14.5	19	30	
		μPC78M15AHF	17.5	23	30	
		μPC78M18AHF	21	27	30	
		μPC78M24AHF	27	33	38	
Output Current	I _o	All	5		350	mA
Operating Junction Temperature Range	T _{opt(j)}	All	- 30		+ 125	°C

ELECTRICAL CHARACTERISTICS μPC78M05A

($V_{IN} = 10\text{ V}$, $I_o = 350\text{ mA}$, $0\text{ °C} \leq T_j \leq +125\text{ °C}$)

CHARACTERISTIC	SYMBOL	TEST CONDITIONS	MIN.	TYP.	MAX.	UNIT
Output Voltage	V_o	$T_j = 25\text{ °C}$	4.8	5.0	5.2	V
		$7\text{ V} \leq V_{IN} \leq 20\text{ V}$, $5\text{ mA} \leq I_o \leq 350\text{ mA}$	4.75		5.25	
		$-30\text{ °C} \leq T_j \leq +125\text{ °C}$	4.75		5.25	
Line Regulation	REG_{IN}	$T_j = 25\text{ °C}$, $7\text{ V} \leq V_{IN} \leq 25\text{ V}$, $I_o = 200\text{ mA}$		3	20	mV
		$T_j = 25\text{ °C}$, $8\text{ V} \leq V_{IN} \leq 25\text{ V}$, $I_o = 200\text{ mA}$		1	15	
Load Regulation	REG_L	$T_j = 25\text{ °C}$, $5\text{ mA} \leq I_o \leq 500\text{ mA}$		3	20	mV
		$T_j = 25\text{ °C}$, $5\text{ mA} \leq I_o \leq 200\text{ mA}$		1	10	
Quiescent Current	I_{BIAS}	$T_j = 25\text{ °C}$		4	6.0	mA
Quiescent Current Change	ΔI_{BIAS}	$8\text{ V} \leq V_{IN} \leq 25\text{ V}$, $I_o = 200\text{ mA}$			0.8	mA
		$5\text{ mA} \leq I_o \leq 350\text{ mA}$			0.5	
Output Noise Voltage	V_n	$T_j = 25\text{ °C}$, $10\text{ Hz} \leq f \leq 100\text{ kHz}$		40		$\mu\text{V}_{r.m.s.}$
Ripple Rejection	$R \cdot R$	$T_j = 25\text{ °C}$, $f = 120\text{ Hz}$, $8\text{ V} \leq V_{IN} \leq 18\text{ V}$, $I_o = 300\text{ mA}$	68	84		dB
Dropout Voltage	V_{DIF}	$T_j = 25\text{ °C}$		2.0		V
Short Circuit Current	I_{Oshort}	$T_j = 25\text{ °C}$, $V_{IN} = 35\text{ V}$		430		mA
Peak Output Current	I_{Opeak}	$T_j = 25\text{ °C}$		1.0		A
Temperature Coefficient of Output Voltage	$\Delta V_o / \Delta T$	$I_o = 5\text{ mA}$		-0.8		mV/°C

ELECTRICAL CHARACTERISTICS μPC78M06A

($V_{IN} = 11\text{ V}$, $I_o = 350\text{ mA}$, $0\text{ °C} \leq T_j \leq +125\text{ °C}$)

CHARACTERISTIC	SYMBOL	TEST CONDITIONS	MIN.	TYP.	MAX.	UNIT
Output Voltage	V_o	$T_j = 25\text{ °C}$	5.76	6.0	6.24	V
		$8.5\text{ V} \leq V_{IN} \leq 21\text{ V}$, $5\text{ mA} \leq I_o \leq 350\text{ mA}$	5.7		6.3	
		$-30\text{ °C} \leq T_j \leq +125\text{ °C}$	5.7		6.3	
Line Regulation	REG_{IN}	$T_j = 25\text{ °C}$, $8.5\text{ V} \leq V_{IN} \leq 25\text{ V}$, $I_o = 200\text{ mA}$		4	20	mV
		$T_j = 25\text{ °C}$, $9\text{ V} \leq V_{IN} \leq 25\text{ V}$, $I_o = 200\text{ mA}$		1.2	15	
Load Regulation	REG_L	$T_j = 25\text{ °C}$, $5\text{ mA} \leq I_o \leq 500\text{ mA}$		4.8	25	mV
		$T_j = 25\text{ °C}$, $5\text{ mA} \leq I_o \leq 200\text{ mA}$		2.4	15	
Quiescent Current	I_{BIAS}	$T_j = 25\text{ °C}$		4	6.0	mA
Quiescent Current Change	ΔI_{BIAS}	$9\text{ V} \leq V_{IN} \leq 25\text{ V}$, $I_o = 200\text{ mA}$			0.8	mA
		$5\text{ mA} \leq I_o \leq 350\text{ mA}$			0.5	
Output Noise Voltage	V_n	$T_j = 25\text{ °C}$, $10\text{ Hz} \leq f \leq 100\text{ kHz}$		45		$\mu\text{V}_{r.m.s.}$
Ripple Rejection	$R \cdot R$	$T_j = 25\text{ °C}$, $f = 120\text{ Hz}$, $9\text{ V} \leq V_{IN} \leq 19\text{ V}$, $I_o = 300\text{ mA}$	67	83		dB
Dropout Voltage	V_{DIF}	$T_j = 25\text{ °C}$		2.0		V
Short Circuit Current	I_{Oshort}	$T_j = 25\text{ °C}$, $V_{IN} = 35\text{ V}$		430		mA
Peak Output Current	I_{Opeak}	$T_j = 25\text{ °C}$		1.0		A
Temperature Coefficient of Output Voltage	$\Delta V_o / \Delta T$	$I_o = 5\text{ mA}$		-1.0		mV/°C

ELECTRICAL CHARACTERISTICS μPC78M07A

($V_{IN} = 12\text{ V}$, $I_o = 350\text{ mA}$, $0\text{ °C} \leq T_j \leq +125\text{ °C}$)

CHARACTERISTIC	SYMBOL	TEST CONDITIONS	MIN.	TYP.	MAX.	UNIT
Output Voltage	V_o	$T_j = 25\text{ °C}$	6.72	7.0	7.28	V
		$9.5\text{ V} \leq V_{IN} \leq 22\text{ V}$, $5\text{ mA} \leq I_o \leq 350\text{ mA}$	6.65		7.35	
		$-30\text{ °C} \leq T_j \leq +125\text{ °C}$	6.65		7.35	
Line Regulation	REG_{IN}	$T_j = 25\text{ °C}$, $9.5\text{ V} \leq V_{IN} \leq 25\text{ V}$, $I_o = 200\text{ mA}$		5	25	mV
		$T_j = 25\text{ °C}$, $10\text{ V} \leq V_{IN} \leq 25\text{ V}$, $I_o = 200\text{ mA}$		1.5	20	
Load Regulation	REG_L	$T_j = 25\text{ °C}$, $5\text{ mA} \leq I_o \leq 500\text{ mA}$		5.6	30	mV
		$T_j = 25\text{ °C}$, $5\text{ mA} \leq I_o \leq 200\text{ mA}$		2.8	15	
Quiescent Current	I_{BIAS}	$T_j = 25\text{ °C}$		4	6.0	mA
Quiescent Current Change	ΔI_{BIAS}	$9.5\text{ V} \leq V_{IN} \leq 25\text{ V}$, $I_o = 200\text{ mA}$			0.8	mA
		$5\text{ mA} \leq I_o \leq 350\text{ mA}$			0.5	
Output Noize Voltage	V_n	$T_j = 25\text{ °C}$, $10\text{ Hz} \leq f \leq 100\text{ kHz}$		50		$\mu V_{r.m.s.}$
Ripple Rejection	$R \cdot R$	$T_j = 25\text{ °C}$, $f = 120\text{ Hz}$, $10\text{ V} \leq V_{IN} \leq 20\text{ V}$, $I_o = 300\text{ mA}$	66	82		dB
Dropout Voltage	V_{DIF}	$T_j = 25\text{ °C}$		2.0		V
Short Circuit Current	I_{Oshort}	$T_j = 25\text{ °C}$, $V_{IN} = 35\text{ V}$		430		mA
Peak Output Current	I_{Opeak}	$T_j = 25\text{ °C}$		1.0		A
Temperature Coefficient of Output Voltage	$\Delta V_o/\Delta T$	$I_o = 5\text{ mA}$		-1.1		mV/°C

ELECTRICAL CHARACTERISTICS μPC78M08A

($V_{IN} = 14\text{ V}$, $I_o = 350\text{ mA}$, $0\text{ °C} \leq T_j \leq +125\text{ °C}$)

CHARACTERISTIC	SYMBOL	TEST CONDITIONS	MIN.	TYP.	MAX.	UNIT
Output Voltage	V_o	$T_j = 25\text{ °C}$	7.7	8.0	8.3	V
		$10.5\text{ V} \leq V_{IN} \leq 23\text{ V}$, $5\text{ mA} \leq I_o \leq 350\text{ mA}$	7.6		8.4	
		$-30\text{ °C} \leq T_j \leq +125\text{ °C}$	7.6		8.4	
Line Regulation	REG_{IN}	$T_j = 25\text{ °C}$, $10.5\text{ V} \leq V_{IN} \leq 25\text{ V}$, $I_o = 200\text{ mA}$		6	30	mV
		$T_j = 25\text{ °C}$, $11\text{ V} \leq V_{IN} \leq 25\text{ V}$, $I_o = 200\text{ mA}$		2	25	
Load Regulation	REG_L	$T_j = 25\text{ °C}$, $5\text{ mA} \leq I_o \leq 500\text{ mA}$		6.4	35	mV
		$T_j = 25\text{ °C}$, $5\text{ mA} \leq I_o \leq 200\text{ mA}$		3.2	20	
Quiescent Current	I_{BIAS}	$T_j = 25\text{ °C}$		4.2	6.0	mA
Quiescent Current Change	ΔI_{BIAS}	$10.5\text{ V} \leq V_{IN} \leq 25\text{ V}$, $I_o = 200\text{ mA}$			0.8	mA
		$5\text{ mA} \leq I_o \leq 350\text{ mA}$			0.5	
Output Noize Voltage	V_n	$T_j = 25\text{ °C}$, $10\text{ Hz} \leq f \leq 100\text{ kHz}$		55		$\mu V_{r.m.s.}$
Ripple Rejection	$R \cdot R$	$T_j = 25\text{ °C}$, $f = 120\text{ Hz}$, $11.5\text{ V} \leq V_{IN} \leq 21.5\text{ V}$, $I_o = 300\text{ mA}$	66	81		dB
Dropout Voltage	V_{DIF}	$T_j = 25\text{ °C}$		2.0		V
Short Circuit Current	I_{Oshort}	$T_j = 25\text{ °C}$, $V_{IN} = 35\text{ V}$		430		mA
Peak Output Current	I_{Opeak}	$T_j = 25\text{ °C}$		1.0		A
Temperature Coefficient of Output Voltage	$\Delta V_o/\Delta T$	$I_o = 5\text{ mA}$		-1.3		mV/°C

ELECTRICAL CHARACTERISTICS μPC78M09A

($V_{IN} = 15\text{ V}$, $I_o = 350\text{ mA}$, $0\text{ °C} \leq T_j \leq +125\text{ °C}$)

CHARACTERISTIC	SYMBOL	TEST CONDITIONS	MIN.	TYP.	MAX.	UNIT
Output Voltage	V _o	T _j = 25 °C	8.64	9.0	9.36	V
		11.5 V ≤ V _{IN} ≤ 24 V, 5 mA ≤ I _o ≤ 350 mA	8.55		9.45	
		- 30 °C ≤ T _j ≤ + 125 °C	8.55		9.45	
Line Regulation	REG _{IN}	T _j = 25 °C, 11.5 V ≤ V _{IN} ≤ 25 V, I _o = 200 mA		6.5	35	mV
		T _j = 25 °C, 12 V ≤ V _{IN} ≤ 25 V, I _o = 200 mA		2	30	
Load Regulation	REG _L	T _j = 25 °C, 5 mA ≤ I _o ≤ 500 mA		7.2	40	mV
		T _j = 25 °C, 5 mA ≤ I _o ≤ 200 mA		3.6	20	
Quiescent Current	I _{BIAS}	T _j = 25 °C		4.2	6.0	mA
Quiescent Current Change	ΔI _{BIAS}	11.5 V ≤ V _{IN} ≤ 25 V, I _o = 200 mA			0.8	mA
		5 mA ≤ I _o ≤ 350 mA			0.5	
Output Noise Voltage	V _n	T _j = 25 °C, 10 Hz ≤ f ≤ 100 kHz		60		μV _{r.m.s.}
Ripple Rejection	R•R	T _j = 25 °C, f = 120 Hz, 12 V ≤ V _{IN} ≤ 22 V, I _o = 300 mA	65	80		dB
Dropout Voltage	V _{DIF}	T _j = 25 °C		2.0		V
Short Circuit Current	I _{Oshort}	T _j = 25 °C, V _{IN} = 35 V		430		mA
Peak Output Current	I _{Opeak}	T _j = 25 °C		1.0		A
Temperature Coefficient of Output Voltage	ΔV _o /ΔT	I _o = 5 mA		- 1.4		mV/°C

ELECTRICAL CHARACTERISTICS μPC78M10A

($V_{IN} = 17\text{ V}$, $I_o = 350\text{ mA}$, $0\text{ °C} \leq T_j \leq +125\text{ °C}$)

CHARACTERISTIC	SYMBOL	TEST CONDITIONS	MIN.	TYP.	MAX.	UNIT
Output Voltage	V _o	T _j = 25 °C	9.6	10.0	10.4	V
		12.5 V ≤ V _{IN} ≤ 25 V, 5 mA ≤ I _o ≤ 350 mA	9.5		10.5	
		- 30 °C ≤ T _j ≤ + 125 °C	9.5		10.5	
Line Regulation	REG _{IN}	T _j = 25 °C, 12.5 V ≤ V _{IN} ≤ 28 V, I _o = 200 mA		7	35	mV
		T _j = 25 °C, 14 V ≤ V _{IN} ≤ 28 V, I _o = 200 mA		2	30	
Load Regulation	REG _L	T _j = 25 °C, 5 mA ≤ I _o ≤ 500 mA		8	40	mV
		T _j = 25 °C, 5 mA ≤ I _o ≤ 200 mA		4	20	
Quiescent Current	I _{BIAS}	T _j = 25 °C		4.3	6.0	mA
Quiescent Current Change	ΔI _{BIAS}	12.5 V ≤ V _{IN} ≤ 28 V			0.8	mA
		5 mA ≤ I _o ≤ 350 mA			0.5	
Output Noise Voltage	V _n	T _j = 25 °C, 10 Hz ≤ f ≤ 100 kHz		65		μV _{r.m.s.}
Ripple Rejection	R•R	T _j = 25 °C, f = 120 Hz, 13 V ≤ V _{IN} ≤ 23 V, I _o = 300 mA	64	79		dB
Dropout Voltage	V _{DIF}	T _j = 25 °C		2.0		V
Short Circuit Current	I _{Oshort}	T _j = 25 °C, V _{IN} = 35 V		430		mA
Peak Output Current	I _{Opeak}	T _j = 25 °C		1.0		A
Temperature Coefficient of Output Voltage	ΔV _o /ΔT	I _o = 5 mA		- 1.6		mV/°C

ELECTRICAL CHARACTERISTICS μPC78M12A

($V_{IN} = 19\text{ V}$, $I_o = 350\text{ mA}$, $0\text{ °C} \leq T_j \leq +125\text{ °C}$)

CHARACTERISTIC	SYMBOL	TEST CONDITIONS	MIN.	TYP.	MAX.	UNIT
Output Voltage	V_o	$T_j = 25\text{ °C}$	11.5	12.0	12.5	V
		$14.5\text{ V} \leq V_{IN} \leq 27\text{ V}$, $5\text{ mA} \leq I_o \leq 350\text{ mA}$	11.4		12.6	
		$-30\text{ °C} \leq T_j \leq +125\text{ °C}$	11.4		12.6	
Line Regulation	REG _{IN}	$T_j = 25\text{ °C}$, $14.5\text{ V} \leq V_{IN} \leq 30\text{ V}$, $I_o = 200\text{ mA}$		8	40	mV
		$T_j = 25\text{ °C}$, $16\text{ V} \leq V_{IN} \leq 30\text{ V}$, $I_o = 200\text{ mA}$		2	30	
Load Regulation	REG _L	$T_j = 25\text{ °C}$, $5\text{ mA} \leq I_o \leq 500\text{ mA}$		9.6	50	mV
		$T_j = 25\text{ °C}$, $5\text{ mA} \leq I_o \leq 200\text{ mA}$		4.8	25	
Quiescent Current	I _{BIAS}	$T_j = 25\text{ °C}$		4.3	6.0	mA
Quiescent Current Change	ΔI_{BIAS}	$14.5\text{ V} \leq V_{IN} \leq 30\text{ V}$, $I_o = 200\text{ mA}$			0.8	mA
		$5\text{ mA} \leq I_o \leq 350\text{ mA}$			0.5	
Output Noize Voltage	V_n	$T_j = 25\text{ °C}$, $10\text{ Hz} \leq f \leq 100\text{ kHz}$		70		μV _{r.m.s.}
Ripple Rejection	R•R	$T_j = 25\text{ °C}$, $f = 120\text{ Hz}$, $15\text{ V} \leq V_{IN} \leq 25\text{ V}$, $I_o = 300\text{ mA}$	62	78		dB
Dropout Voltage	V _{DIF}	$T_j = 25\text{ °C}$		2.0		V
Short Circuit Current	I _{Oshort}	$T_j = 25\text{ °C}$, $V_{IN} = 35\text{ V}$		430		mA
Peak Output Current	I _{Opeak}	$T_j = 25\text{ °C}$		1.0		A
Temperature Coefficient of Output Voltage	$\Delta V_o/\Delta T$	$I_o = 5\text{ mA}$		-1.9		mV/°C

ELECTRICAL CHARACTERISTICS μPC78M15A

($V_{IN} = 23\text{ V}$, $I_o = 350\text{ mA}$, $0\text{ °C} \leq T_j \leq +125\text{ °C}$)

CHARACTERISTIC	SYMBOL	TEST CONDITIONS	MIN.	TYP.	MAX.	UNIT
Output Voltage	V_o	$T_j = 25\text{ °C}$	14.4		15.6	V
		$17.5\text{ V} \leq V_{IN} \leq 30\text{ V}$, $5\text{ mA} \leq I_o \leq 350\text{ mA}$	14.25		15.75	
		$-30\text{ °C} \leq T_j \leq +125\text{ °C}$	14.25		15.75	
Line Regulation	REG _{IN}	$T_j = 25\text{ °C}$, $17.5\text{ V} \leq V_{IN} \leq 30\text{ V}$, $I_o = 200\text{ mA}$		10	50	mV
		$T_j = 25\text{ °C}$, $20\text{ V} \leq V_{IN} \leq 30\text{ V}$, $I_o = 200\text{ mA}$		3	40	
Load Regulation	REG _L	$T_j = 25\text{ °C}$, $5\text{ mA} \leq I_o \leq 500\text{ mA}$		12	60	mV
		$T_j = 25\text{ °C}$, $5\text{ mA} \leq I_o \leq 200\text{ mA}$		6	30	
Quiescent Current	I _{BIAS}	$T_j = 25\text{ °C}$		4.4	6.0	mA
Quiescent Current Change	ΔI_{BIAS}	$17.5\text{ V} \leq V_{IN} \leq 30\text{ V}$, $I_o = 300\text{ mA}$			0.8	mA
		$5\text{ mA} \leq I_o \leq 350\text{ mA}$			0.5	
Output Noize Voltage	V_n	$T_j = 25\text{ °C}$, $10\text{ Hz} \leq f \leq 100\text{ kHz}$		85		μV _{r.m.s.}
Ripple Rejection	R•R	$T_j = 25\text{ °C}$, $f = 120\text{ Hz}$, $18.5\text{ V} \leq V_{IN} \leq 28.5\text{ V}$, $I_o = 300\text{ mA}$	60	75		dB
Dropout Voltage	V _{DIF}	$T_j = 25\text{ °C}$		2.0		V
Short Circuit Current	I _{Oshort}	$T_j = 25\text{ °C}$, $V_{IN} = 35\text{ V}$		430		mA
Peak Output Current	I _{Opeak}	$T_j = 25\text{ °C}$		1.0		A
Temperature Coefficient of Output Voltage	$\Delta V_o/\Delta T$	$I_o = 5\text{ mA}$		-2.4		mV/°C

ELECTRICAL CHARACTERISTICS μPC78M18A

($V_{IN} = 27\text{ V}$, $I_o = 350\text{ mA}$, $0\text{ °C} \leq T_j \leq +125\text{ °C}$)

CHARACTERISTIC	SYMBOL	TEST CONDITIONS	MIN.	TYP.	MAX.	UNIT
Output Voltage	V_o	$T_j = 25\text{ °C}$	17.3	18.0	18.7	V
		$21\text{ V} \leq V_{IN} \leq 33\text{ V}$, $5\text{ mA} \leq I_o \leq 350\text{ mA}$	17.1		18.9	
		$-30\text{ °C} \leq T_j \leq +125\text{ °C}$	17.1		18.9	
Line Regulation	REG_{IN}	$T_j = 25\text{ °C}$, $21\text{ V} \leq V_{IN} \leq 33\text{ V}$, $I_o = 200\text{ mA}$		10	50	mV
		$T_j = 25\text{ °C}$, $24\text{ V} \leq V_{IN} \leq 30\text{ V}$, $I_o = 200\text{ mA}$		4	40	
Load Regulation	REG_L	$T_j = 25\text{ °C}$, $5\text{ mA} \leq I_o \leq 500\text{ mA}$		14.4	75	mV
		$T_j = 25\text{ °C}$, $5\text{ mA} \leq I_o \leq 200\text{ mA}$		7.2	40	
Quiescent Current	I_{BIAS}	$T_j = 25\text{ °C}$		4.6	6.0	mA
Quiescent Current Change	ΔI_{BIAS}	$21\text{ V} \leq V_{IN} \leq 33\text{ V}$, $I_o = 200\text{ mA}$			0.8	mA
		$5\text{ mA} \leq I_o \leq 350\text{ mA}$			0.5	
Output Noise Voltage	V_n	$T_j = 25\text{ °C}$, $10\text{ Hz} \leq f \leq 100\text{ kHz}$		100		μV _{r.m.s.}
Ripple Rejection	$R \cdot R$	$T_j = 25\text{ °C}$, $f = 120\text{ Hz}$, $22\text{ V} \leq V_{IN} \leq 32\text{ V}$, $I_o = 300\text{ mA}$	57	73		dB
Dropout Voltage	V_{DIF}	$T_j = 25\text{ °C}$		2.0		V
Short Circuit Current	I_{Oshort}	$T_j = 25\text{ °C}$, $V_{IN} = 35\text{ V}$		430		mA
Peak Output Current	I_{Opeak}	$T_j = 25\text{ °C}$		1.0		A
Temperature Coefficient of Output Voltage	$\Delta V_o / \Delta T$	$I_o = 5\text{ mA}$		-2.9		mV/°C

ELECTRICAL CHARACTERISTICS μPC78M24A

($V_{IN} = 33\text{ V}$, $I_o = 350\text{ mA}$, $0\text{ °C} \leq T_j \leq +125\text{ °C}$)

CHARACTERISTIC	SYMBOL	TEST CONDITIONS	MIN.	TYP.	MAX.	UNIT
Output Voltage	V_o	$T_j = 25\text{ °C}$	23.0	24.0	25.0	V
		$27\text{ V} \leq V_{IN} \leq 38\text{ V}$, $5\text{ mA} \leq I_o \leq 350\text{ mA}$	22.8		25.2	
		$-30\text{ °C} \leq T_j \leq +125\text{ °C}$	22.8		25.2	
Line Regulation	REG_{IN}	$T_j = 25\text{ °C}$, $27\text{ V} \leq V_{IN} \leq 38\text{ V}$, $I_o = 200\text{ mA}$		10	50	mV
		$T_j = 25\text{ °C}$, $28\text{ V} \leq V_{IN} \leq 38\text{ V}$, $I_o = 200\text{ mA}$		5	40	
Load Regulation	REG_L	$T_j = 25\text{ °C}$, $5\text{ mA} \leq I_o \leq 500\text{ mA}$		19.2	100	mV
		$T_j = 25\text{ °C}$, $5\text{ mA} \leq I_o \leq 200\text{ mA}$		9.6	50	
Quiescent Current	I_{BIAS}	$T_j = 25\text{ °C}$		4.8	6.0	mA
Quiescent Current Change	ΔI_{BIAS}	$27\text{ V} \leq V_{IN} \leq 38\text{ V}$, $I_o = 200\text{ mA}$			0.8	mA
		$5\text{ mA} \leq I_o \leq 350\text{ mA}$			0.5	
Output Noise Voltage	V_n	$T_j = 25\text{ °C}$, $10\text{ Hz} \leq f \leq 100\text{ kHz}$		120		μV _{r.m.s.}
Ripple Rejection	$R \cdot R$	$T_j = 25\text{ °C}$, $f = 120\text{ Hz}$, $28\text{ V} \leq V_{IN} \leq 38\text{ V}$, $I_o = 300\text{ mA}$	52	68		dB
Dropout Voltage	V_{DIF}	$T_j = 25\text{ °C}$		2.0		V
Short Circuit Current	I_{Oshort}	$T_j = 25\text{ °C}$, $V_{IN} = 35\text{ V}$		430		mA
Peak Output Current	I_{Opeak}	$T_j = 25\text{ °C}$		1.0		A
Temperature Coefficient of Output Voltage	$\Delta V_o / \Delta T$	$I_o = 5\text{ mA}$		-3.8		mV/°C

TYPICAL CHARACTERISTICS (T_a = 25 °C)

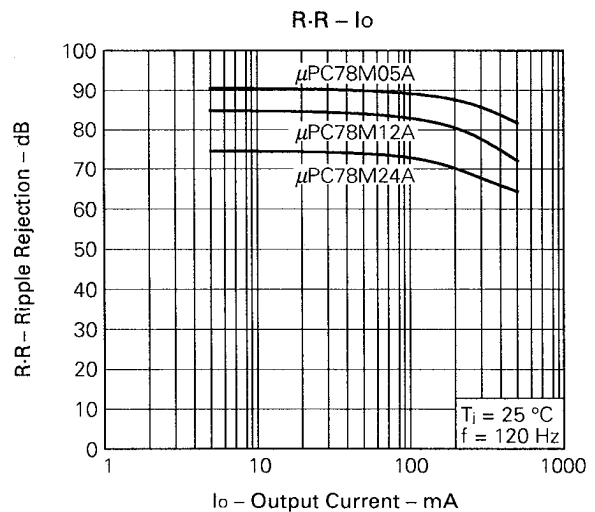
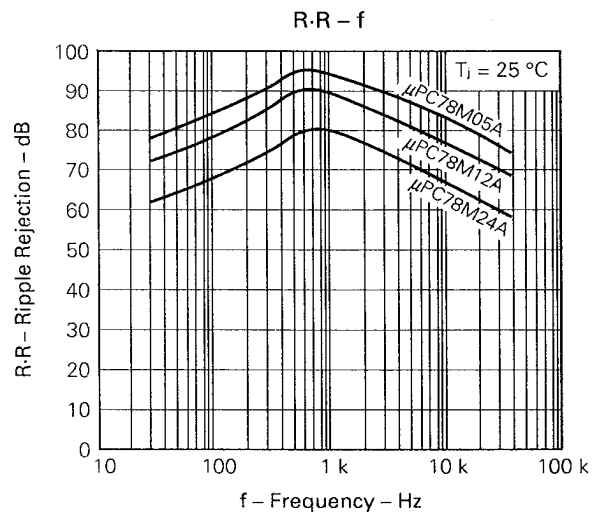
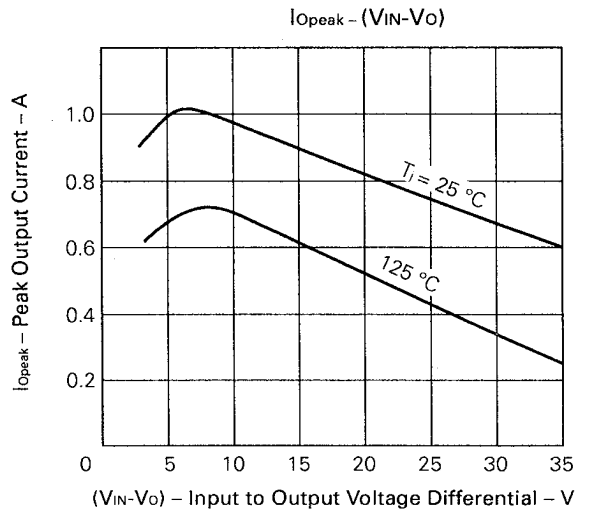
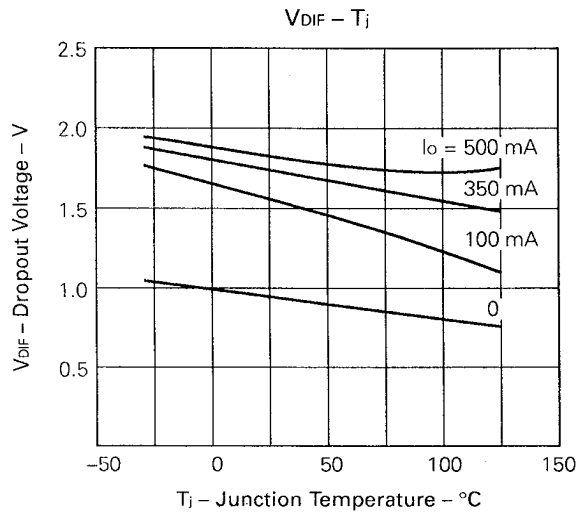
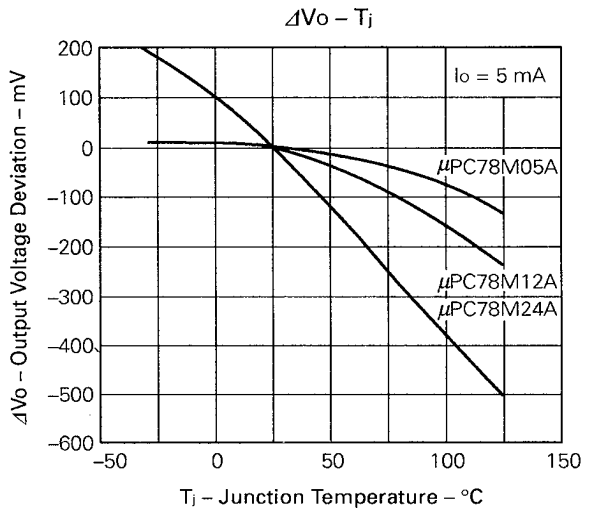
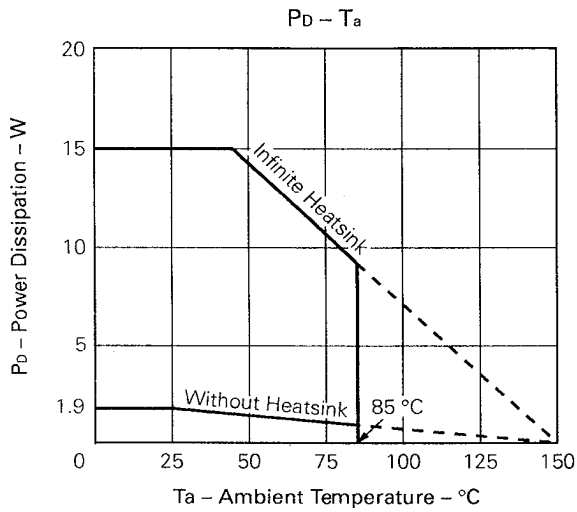

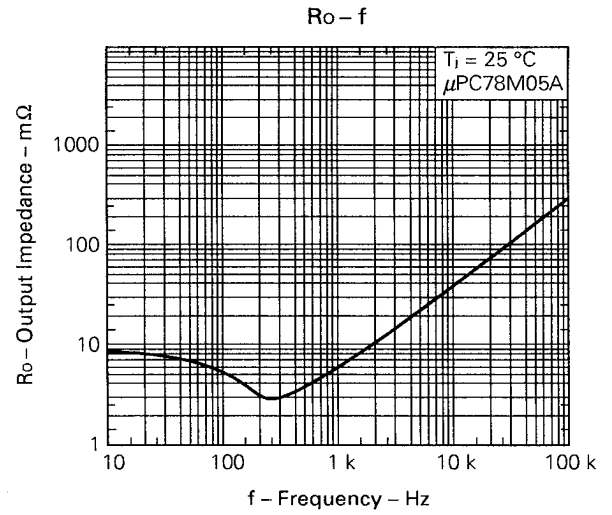
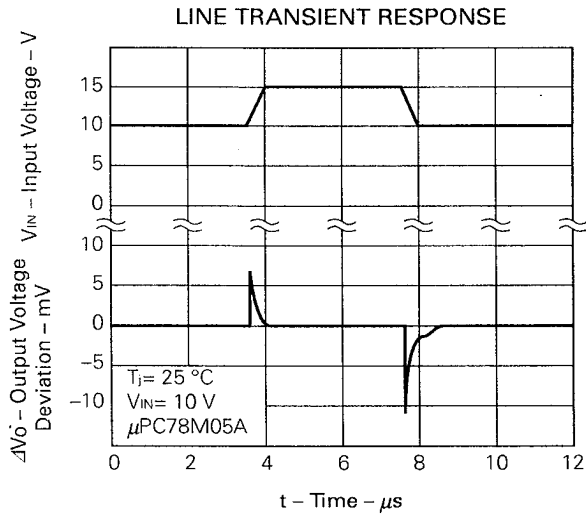
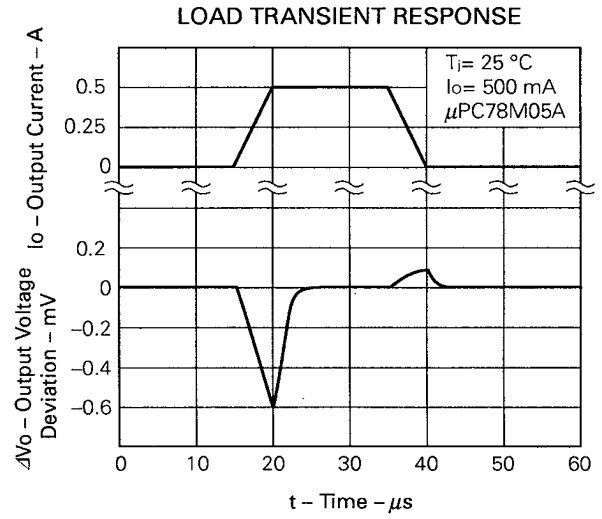
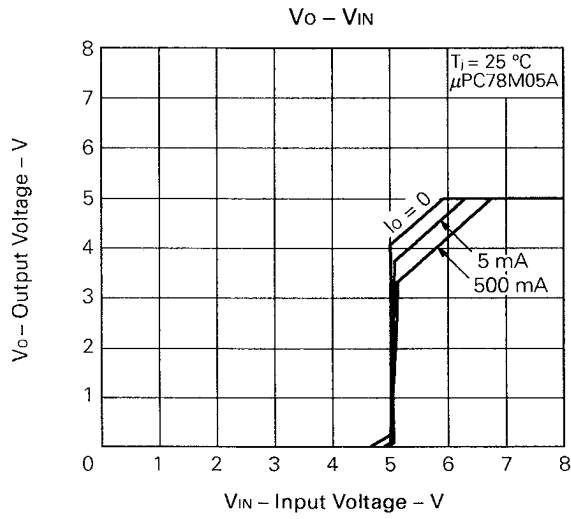

PACKAGE DIMENSIONS

3PIN PLASTIC SIP (MP-45G)

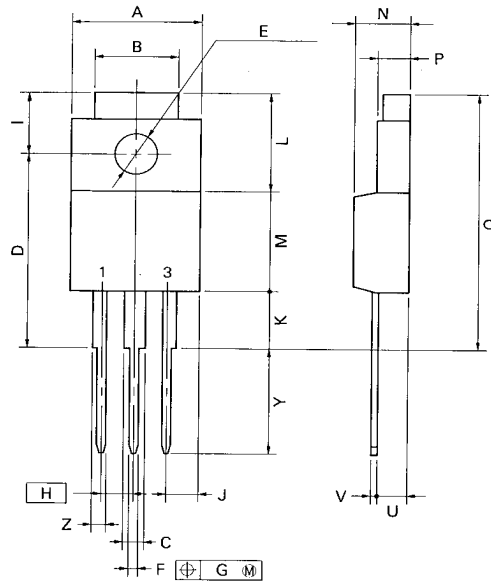

P3HF-254B-1

NOTE

Each lead centerline is located within 0.25 mm (0.01 inch) of its true position (T.P.) at maximum material condition.

ITEM	MILLIMETERS	INCHES
A	10.4 MAX.	0.410 MAX.
B	7.0	0.276
C	1.2 MIN.	0.047 MIN.
D	17.0 ^{±0.3}	0.669 ^{+0.013} _{-0.012}
E	φ3.3 ^{±0.2}	φ0.130 ^{±0.008}
F	0.75 ^{±0.10}	0.030 ^{+0.004} _{-0.005}
G	0.25	0.010
H	2.54 (T.P.)	0.100 (T.P.)
I	5.0 ^{±0.3}	0.197 ^{±0.012}
J	2.66 MAX.	0.105 MAX.
K	4.8 MIN.	0.188 MIN.
L	8.5	0.335
M	8.5	0.335
N	4.5 ^{±0.2}	0.177 ^{±0.008}
P	2.8 ^{±0.2}	0.110 ^{+0.009} _{-0.008}
Q	22.4 MAX.	0.882 MAX.
U	2.4 ^{±0.5}	0.094 ^{+0.021} _{-0.020}
V	0.65 ^{±0.10}	0.026 ^{+0.004} _{-0.005}
Y	8.9 ^{±0.7}	0.350 ^{±0.028}
Z	1.0 MIN.	0.039 MIN.