



2005 GENERAL PRODUCTS CATALOG

総合カタログ



SUMIDA CORPORATION

GENERAL PRODUCTS

INDEX	PAGE
Scope of Sumida products, General stipulations for coil use	3

NEW PRODUCTS

POWER INDUCTORS	CMCM104 CDEP125ME	4
	CDH2D09(/S) CDH3D11(/S) CDSH3D11(/S)	5
	CDRH8D38/A CDRH127C/A	6
	CDR6D23MN CDR6D28MN CDR7D28MN CDR7D43MN	7
	CDR10D48MN	8
	CDRH4D16FB CDRH5D16F/LD CDPH4D19F CDRH6D26FB CDRH10D43F	9 - 10
L.P.F.COILS FOR DIGITAL AMP	CDEP1106 DEPI1615	11
INVERTER TRANSFORMERS	CPUDL294 CEIDL318 CEIDL377 CEIDL369 EIDL369	24 - 25
	CIUH11D66	26
INVERTER UNIT	IV120307	27
DC/DC CONVERTER TRANSFORMERS	CLS4D18 CLS4D28 CLS6D28	32
	CLO5D27 CLO7D23	33
SIGNAL COMMON MODE CHOKE COILS	CPFC805 CPF6D36	41
	CBM6068	42
ANTENNA/FILTER	AS737	47
	CEP79	48
For xDSL LINE TRANSFORMERS	CPE1311C	52
	CEP1311 EP1311	53
GAS DISCHARGE TUBE	Switching Spark Gaps- <i>Sparctube</i> ™	72 - 73

PRODUCTS

POWER INDUCTORS	SMD TYPE	12 - 20
	PIN TYPE	21 - 23
INVERTER TRANSFORMERS	SMD TYPE	28 - 30
	PIN TYPE	31
DC/DC CONVERTER TRANSFORMERS	SMD TYPE	34 - 36
	PIN TYPE	37 - 40
SIGNAL COMMON MODE CHOKE COILS		43
DC COMMON MODE CHOKE COILS		43
NORMAL MODE CHOKE COILS		44
AC COMMON MODE CHOKE COILS		45 - 46
ANTENNAS		49 - 50
For xDSL LINE TRANSFORMERS		51
For xDSL POTS SPLITTER COILS		54 - 55
For xDSL COMMON MODE CHOKE COIL		56
STB/FAX/MODEM TRANSFORMERS		57 - 61
LAN LINE TRANSFORMERS		62
10/100 BESE PULSE TRANSFORMERS		63
RADIO CONTROL CLOCK ANTENNAS		64
AUDIO/VIDEO FILTERS		65
IFT		66
RF COILS		67
QUADRATURE DETECTOR COILS		68
VCO COIL		68
HELICAL FILTER		68
ANTENNA LOADING COIL		68
MOLD COILS		69
BALUN		69
FIXED INDUCTORS FOR TAPE RECORDER		70
VARIABLE INDUCTORS		71

Dimensions for embossed tape and reel packing with packed QTY	74-75
--	--------------

- Specifications in this catalog are subject to change without notice. It is requested to confirm the specifications when ordering.
- Any dimensions without tolerance is typical value.
- Sumida declares that any ozone depleting substance is not used in the all coil manufacturing process.
- We recommend to use resist to protect from solder bridge.

● Scope of Sumida products

1. Sumida components are manufactured and promoted for use in general AV electronics, home appliances, OAs, communications, measurement equipments and machine tools.
2. In the event the product is used in aerospace equipment, medical equipment, transportation equipment, disaster preventing equipment, or an equivalent which may affect human health or property, please do not fail to consult with our business headquarters, branch or business office.
When the suggested recommendations are not heeded, Sumida Group shall not be held liable for any dysfunction in or damage to the equipment with which the product is used.
3. In the event a problem occurs which may affect industrial property and any other rights of Sumida Group (or a third party) during the use of the product and information described in this catalog, Sumida Group shall not be held liable for any such problem, nor grant any license to the offending party.

● General stipulations for coil use

1. Products should not be kept in unsuitable storage conditions, such as areas susceptible to high temperatures, high humidity, dust or corrosion.
2. Always handle products with care.
3. Don't touch electrodes directly with bare hands as oil secretions may inhibit soldering.
Always ensure optimum conditions for soldering.
4. Don't bend the terminals or subject them to excessive stress.
5. Please ensure that all terminals and case lugs are completely fixed with solder onto PCB.
6. Ensure the tuning slug or cap is not fixed by solder flux during the production process.
7. Refrain from rinsing coils. If necessary, please consult with our company.
8. Avoid placing coils near the edge of the PCB.
9. Our SMD coils are designed for automatic mounting. Please be careful if soldering by hand.
10. Don't touch any exposed winding part and avoid coming into contact with the guide of electrode in automatic mounting.
11. Our specification limits the quality of the component as a single unit.
Please ensure the component is thoroughly evaluated in your application circuit.
12. When using our high voltage inverter transformers, place 2mm away from the electric conductor.
13. About Lead-free Products
 - Lead-free products are now available for sale
 - To order a lead-free product, please add "NP" after the product type:
e.g. Ordering code of lead product: Type name-△△△○×
Ordering code of lead-free product: Type name NP△△△○×

Power Inductors <SMD Type>

POWER INDUCTORS

OUTLINE

By using the square wire, power inductors can be used for large current with low profile and low resistance.

CMCM104

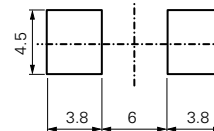
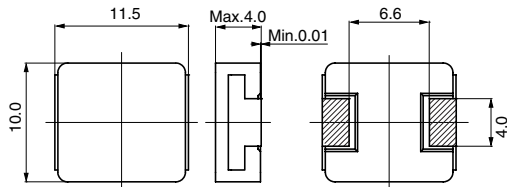
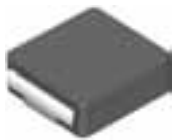
DIMENSIONS (mm)
LAND PATTERNS (mm)

PROVISIONAL
SPECIFICATIONS

Part No.	Inductance	D.C.R. (Ω)		Saturation Rated Current (A)	
		Max.	(Typ.)	(at 20°C) ※1	Temperature Rise Current (typ) (A) ※2
CMCM104	0.36μH±20%	1.20m		37.0※1	27.0

※1: Saturation Rated Current: The current when the inductance becomes 20% lower than its initial value.
 ※2: Temperature Rise Current (Typ.): The actual current when temperature of coil becomes ΔT=40°C (Ta=20°C)

OUTLINE

By using the square wire, power inductors can be used for large current with low profile and low resistance.

CDEP125ME

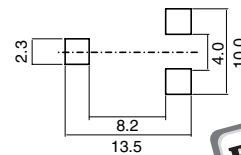
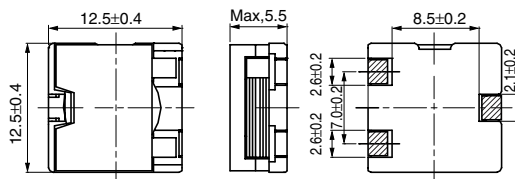
DIMENSIONS (mm)
LAND PATTERNS (mm)

PROVISIONAL
SPECIFICATIONS

Part No.	Inductance	D.C.R. (Ω)		Saturation Rated Current (A)	
		Max.	(Typ.)	(at 20°C) ※1	Temperature Rise Current (typ) (A) ※2
CDEP12SMENP-0R3MC	0.3μH±25%	1.00m		40.0	21.0
CDEP12SMENP-0R7MC	0.7μH±25%	1.70m		32.0	20.0
CDEP12SMENP-1R2MC	1.2μH±25%	2.60m		25.6	17.5
CDEP12SMENP-2R0MC	2.0μH±25%	4.10m		20.4	13.5
CDEP12SMENP-2R9MC	2.9μH±25%	6.30m		16.0	11.5

※1: Saturation Rated Current: The current when the inductance becomes 20% lower than its nominal value.
 ※2: Temperature Rise Current (Typ.): The actual current when temperature of coil becomes ΔT=40°C (Ta=20°C)

About CMCM104, CDEP125ME

※This specification might be changed without notice due to under developing and improving. Thank you for your understanding.

Inductors for Low Profile

OUTLINE

This is low profile type of power inductor for portable equipment.
It is suitable for a DC/DC converter power supply with height restrictions.

CDH2D09/S CDH2D09



● DIMENSIONS (mm)

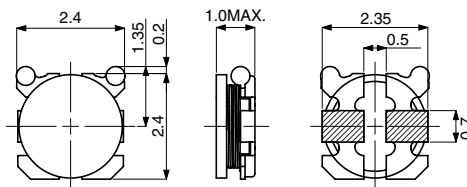

● LAND PATTERNS (mm)

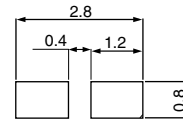

PROVISIONAL

CDH3D11/S CDH3D11



● DIMENSIONS (mm)

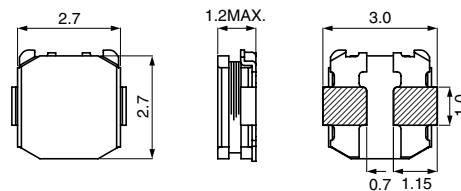

● LAND PATTERNS (mm)

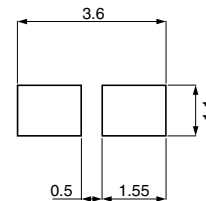

PROVISIONAL

CDSH3D11/S CDSH3D11



● DIMENSIONS (mm)

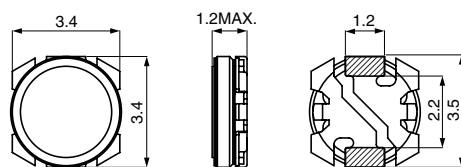

● LAND PATTERNS (mm)

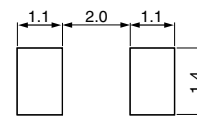

PROVISIONAL

● SPECIFICATIONS

Part No.	Inductance	D.C.R.(Ω)		Saturation Rated Current (A)		Temperature Rise Current (typ) (A)
		Max. (Typ.)		(at 20°C)		※4
CDH2D09/S, CDH2D09	4.7μH	456m (380m)		380m※1		630m
CDH3D11/S, CDH3D11	4.7μH	504m (420m)		850m※2		560m
CDSH3D11/S, CDSH3D11	4.7μH	219m (175m)		660m※3		840m

※1: Saturation Rated Current: The current when the inductance becomes 25% lower than its nominal value.

※2: Saturation Rated Current: The current when the inductance becomes 10% lower than its initial value.

※3: Saturation Rated Current: The current when the inductance becomes 35% lower than its nominal value.

※4: Temperature Rise Current (Typ.): The actual current when temperature of coil becomes $\Delta T=40^{\circ}\text{C}$ ($T_a=20^{\circ}\text{C}$)

About CDH2D09/S CDH2D09, CDH3D11/S CDH3D11, CDSH3D11/S CDSH3D11

※This specification might be changed without notice due to under developing and improving. Thank you for your understanding.

Inductors Corresponding High Temperature

OUTLINE

The operating temperature range is a maximum of 125 degree, and the inductance range is 10~470uH. It matches as power inductor for DC/DC converters corresponding high temperature.

CDRH8D38/A

DIMENSIONS (mm)

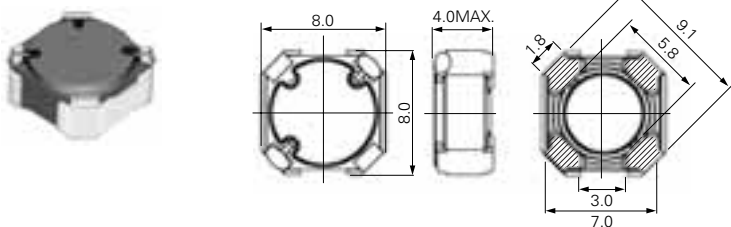

LAND PATTERNS (mm)

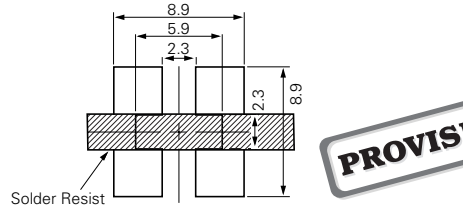

PROVISIONAL

CDRH127C/A

DIMENSIONS (mm)

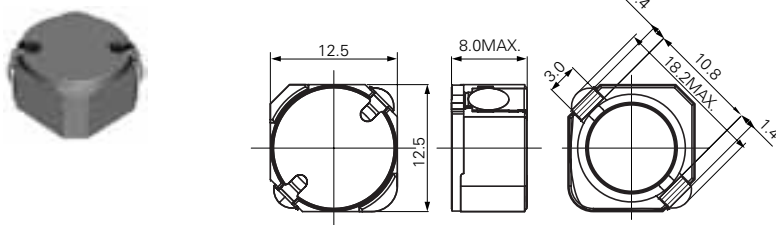

LAND PATTERNS (mm)

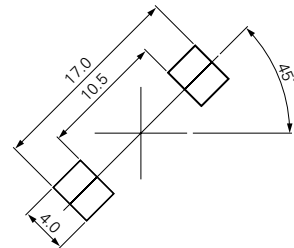

Inductance Range

CDRH8D38/A : 10μH-100μH
CDRH127C/A : 10μH-470μH

Characteristics

CDRH8D38/A

Saturation Current

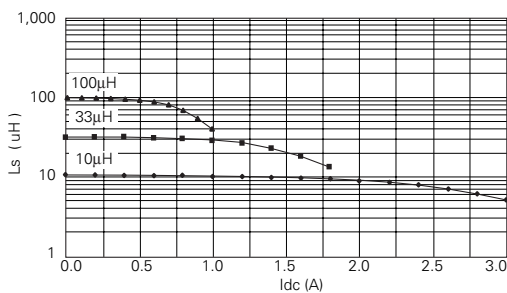

Temperature Rise

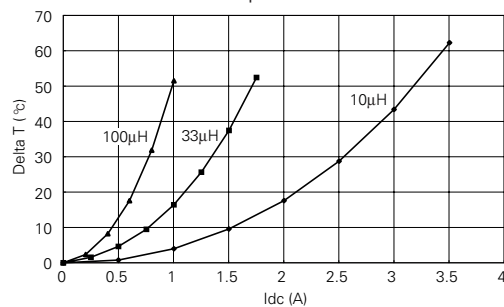

CDRH127C/A

Saturation Current

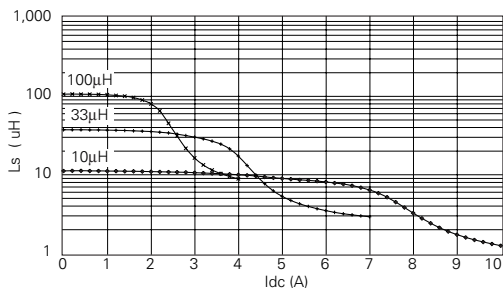

Temperature Rise

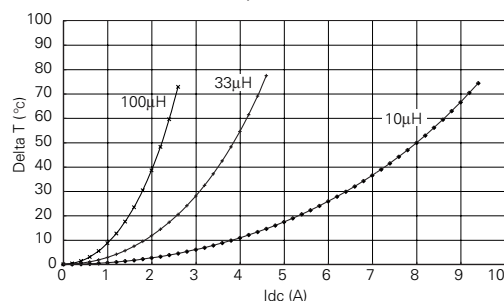

About CDRH8D38/A

※This specification might be changed without notice due to under developing and improving. Thank you for your understanding.

NEW PRODUCTS

Hybrid Power Inductors

POWER INDUCTORS

OUTLINE

The combination of the Mn ferrite core and the Ni ferrite core achieves the large current and the smaller volume approximately 18% as compared to previous type.

The series has the foot print lineup of 6 mm, 7 mm, and 10 mm square, so the lineup matches power supplies for portable PCs, DVCs, DSCs, LCD-TVs, and low profile type on-board power supplies.

CDR6D23MN

● DIMENSIONS(mm)

● LAND PATTERNS(mm)

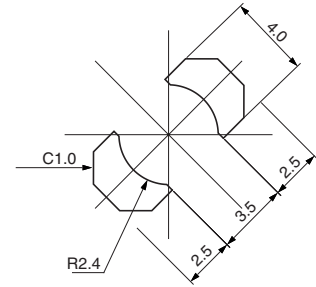
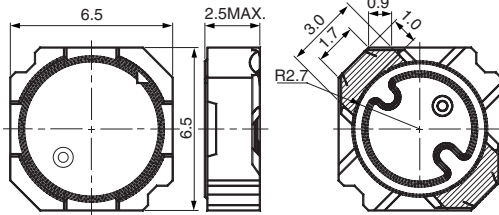

CDR6D28MN

● DIMENSIONS(mm)

● LAND PATTERNS(mm)

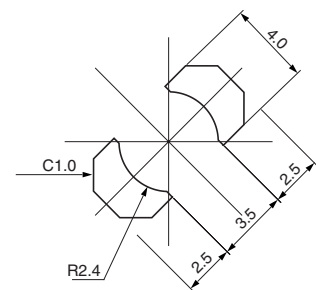
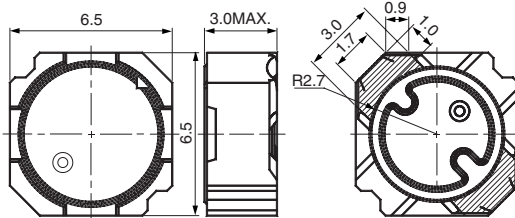

CDR7D28MN

● DIMENSIONS(mm)

● LAND PATTERNS(mm)

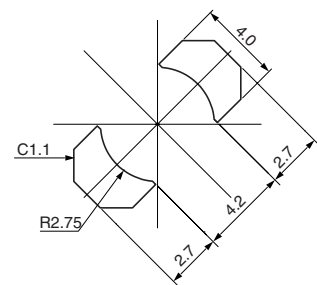
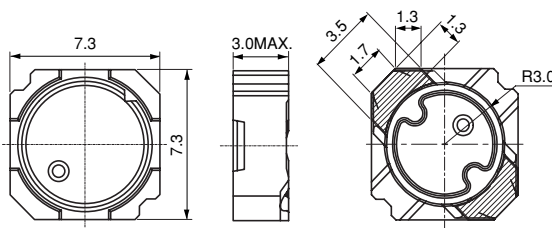

CDR7D43MN

● DIMENSIONS(mm)

● LAND PATTERNS(mm)

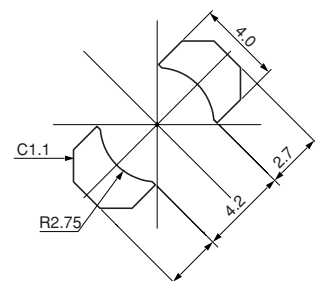
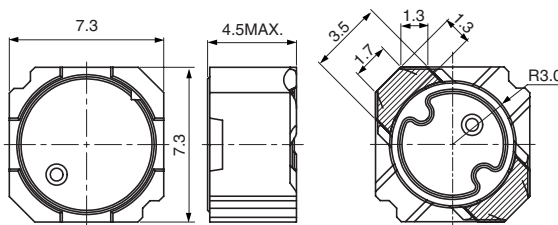

Hybrid Power Inductors

CDR10D48MN

● DIMENSIONS (mm)

● LAND PATTERNS (mm)



PROVISIONAL

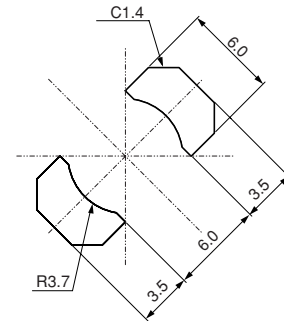
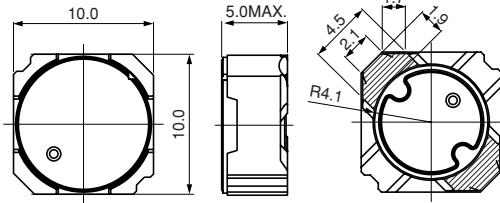

● Inductance Range

CDR6D23MN	: 2.0 μ H - 100 μ H
CDR6D28MN	: 1.5 μ H - 120 μ H
CDR7D28MN	: 1.2 μ H - 470 μ H
CDR7D43MN	: 3.7 μ H - 100 μ H
CDR10D48MN	: 2.4 μ H - 120 μ H

※Measurement frequency of inductance : at 100kHz

Saturation Current

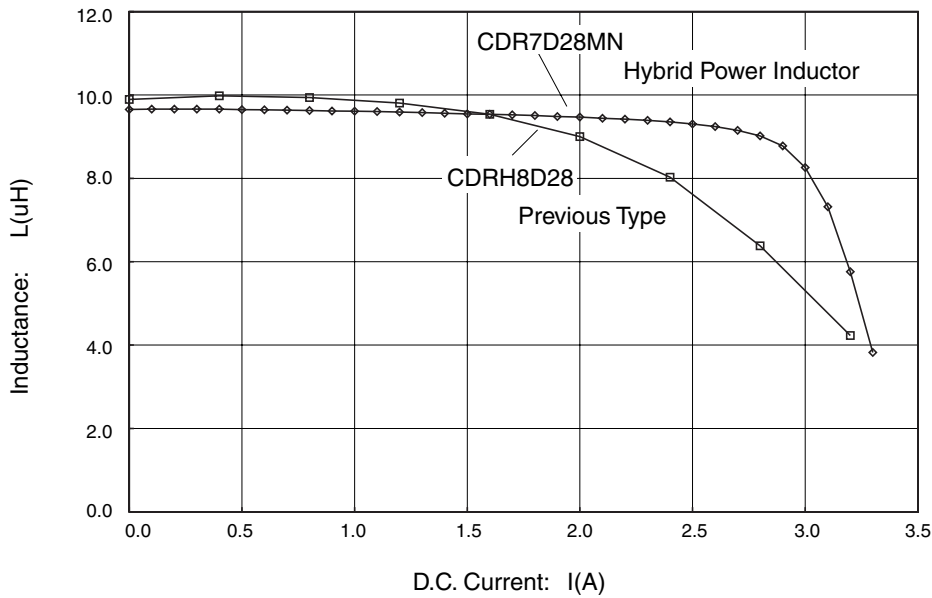

About CDR10D48MN

※This specification might be changed without notice due to under developing and improving. Thank you for your understanding.

NEW PRODUCTS

Double Flat Winding Inductors

POWER INDUCTORS

OUTLINE

It is suitable for the power inductor for chopper circuit of DC/DC converters for the power supply of portable equipment. Having adopted double flat winding technology, it is a product which corresponds to a low profile power supply model with lower DCR demand for DVC.e.t.c.

CDRH4D16FB

● DIMENSIONS(mm)

● LAND PATTERNS(mm)

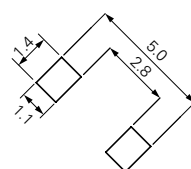
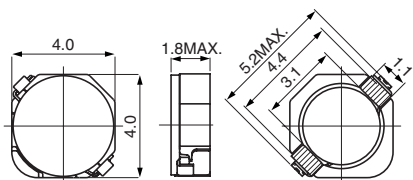

CDRH5D16F/LD

● DIMENSIONS(mm)

● LAND PATTERNS(mm)

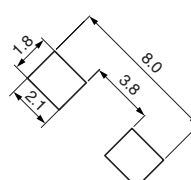
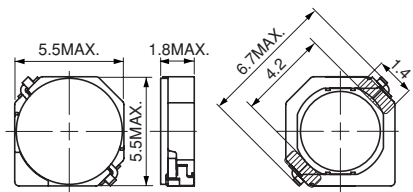

CDPH4D19F

● DIMENSIONS(mm)

● LAND PATTERNS(mm)

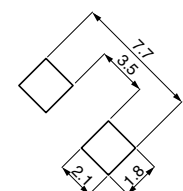
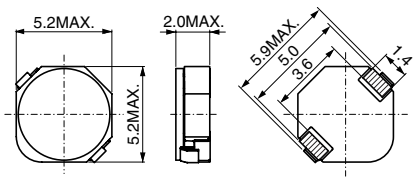

CDRH6D26FB

● DIMENSIONS(mm)

● LAND PATTERNS(mm)

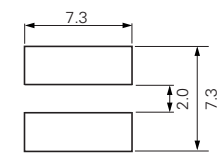
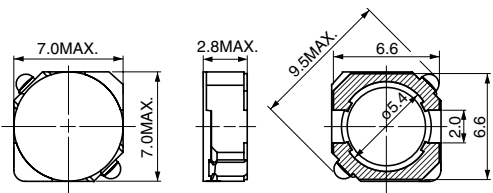

CDRH10D43F

● DIMENSIONS(mm)

● LAND PATTERNS(mm)

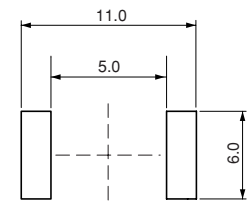
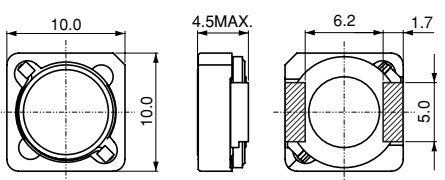

Double Flat Winding Inductors

POWER INDUCTORS

● Inductance Range

CDRH4D16FB	: 4.7 μ H - 33 μ H
CDRH5D16F/LD	: 2.2 μ H - 47 μ H
CDPH4D19F	: 3.3 μ H - 47 μ H
CDRH6D26FB	: 2.2 μ H - 22 μ H
CDRH10D43F	: 4.7 μ H - 33 μ H

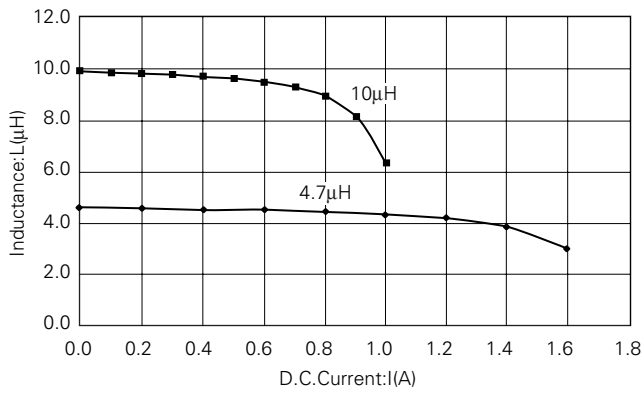
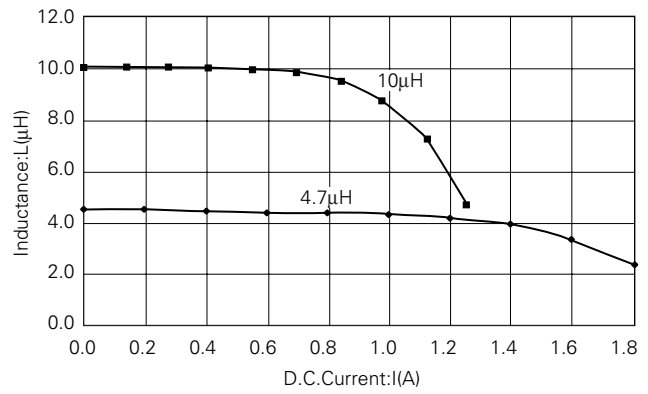
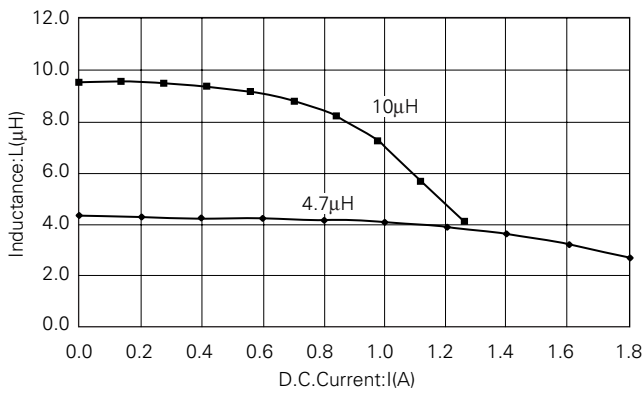
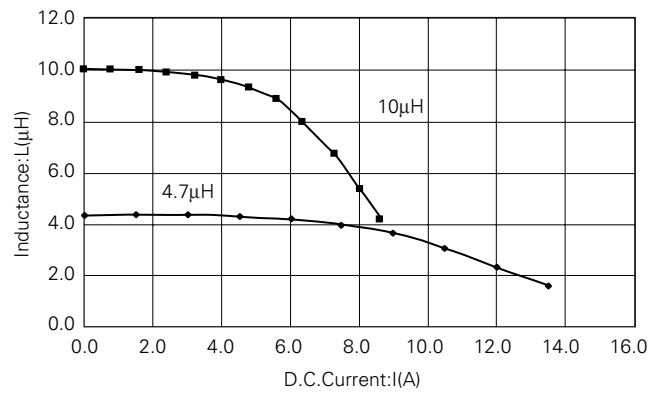
● CDRH4D16FB: Saturation Current

● CDRH5D16F/LD: Saturation Current

● CDPH4D19F: Saturation Current

● CDRH10D43F: Saturation Current

About CDRH4D16FB, CDRH10D43F

※This specification might be changed without notice due to under developing and improving. Thank you for your understanding.

L.P.F Coils for Digital AMP

OUTLINE

It is the inductor for LPF used in the digital amplifier featuring with higher efficiency and lower heat generation.

It is a product which corresponds to the demand of SMD type and smaller foot print (two in one type LPF) for 1 speaker.

Applications are car audios, 5.1ch home theater sets and large LCDs.

CDEPI106

DIMENSIONS(mm)

LAND PATTERNS(mm)

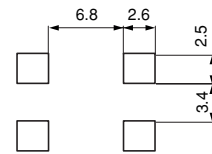
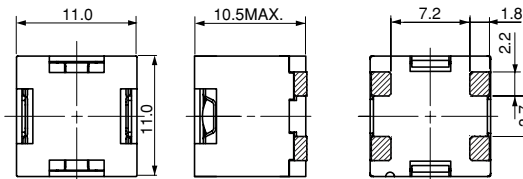

SPECIFICATIONS

Part No.	Stamp	Inductance (WITHIN) ※1 (1-2), (4-3)	D.C.R.(mΩ) Max. (Typ) ※2 (1-2), (4-3)	Saturation Rated Current (A) ※3		Temperature Rise Rated Current (A) ※4
				(at 20°C)	(at 105°C)	
CDEPI106NP-100	100	10μH±25%	28.8(23)	4.9	4.5	4.0
CDEPI106NP-150	150	15μH±25%	28.8(23)	3.5	3.0	4.0
CDEPI106NP-220	220	22μH±30%	28.8(23)	2.2	1.9	4.0

※1: Measurement frequency of inductance : at 100kHz

※2: () is typical value.

※3: Saturation Rated Current : It indicates the D.C. current value when inductance value become more than 75% of the nominal one.

※4: The Temperature Rise Rated Current : The value of D.C. current when temperature rise is Δt=40°C (Ta=20°C).

DEPI1615

DIMENSIONS(mm)

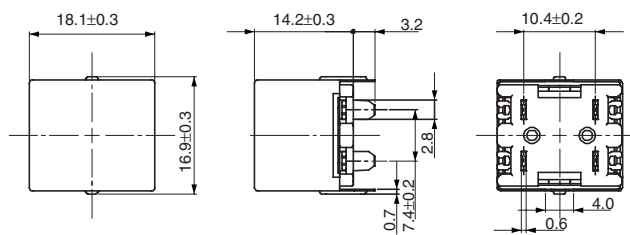

SPECIFICATIONS

Part No.	Stamp	Inductance (WITHIN) ※1 (1-2), (4-3)	D.C.R.(mΩ) ※2 (1-2), (4-3)	Saturation Rated Current (A) ※3		Temperature Rise Rated Current (A) ※4
				(at 20°C)	(at 105°C)	
DEPI1615-100	100	10μH±20%	14.8 (12.3)	9.6	7.6	8.5
DEPI1615-150	150	15μH±20%	20.6 (17.2)	8.4	6.5	6.0
DEPI1615-220	220	22μH±20%	29.0 (24.2)	6.8	5.3	4.3

※1: Measurement frequency of inductance : at 100kHz

※2: () is typical value.











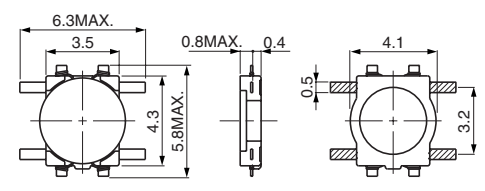

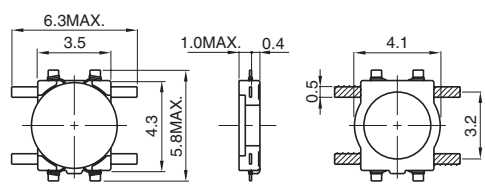

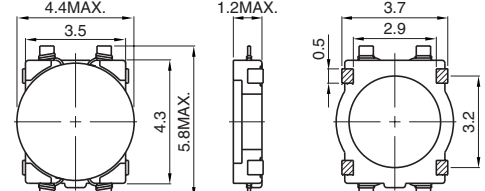

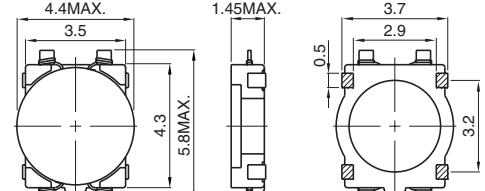
※3: Saturation Rated Current : It indicates the D.C. current value when inductance value become more than 75% of the nominal one.

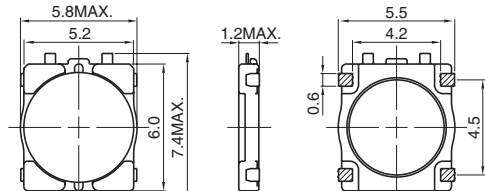
※4: The Temperature Rise Rated Current : The value of D.C. current when temperature rise is Δt=40°C (Ta=20°C).

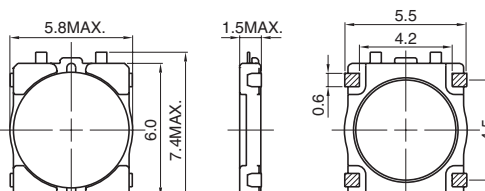

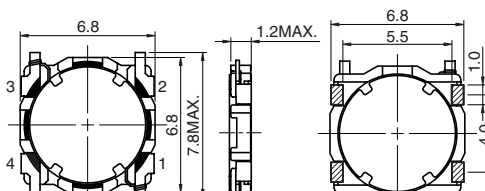



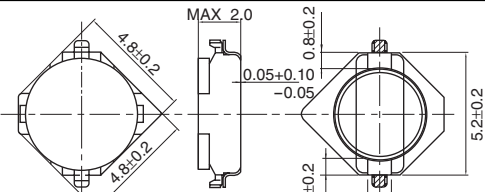



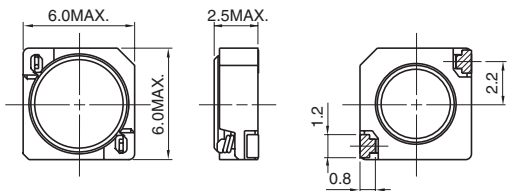

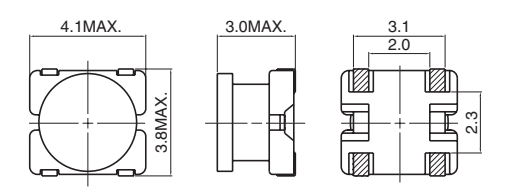
About DEPI1615

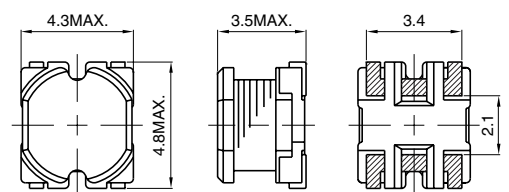
※This specification might be changed without notice due to under developing and improving. Thank you for your understanding.

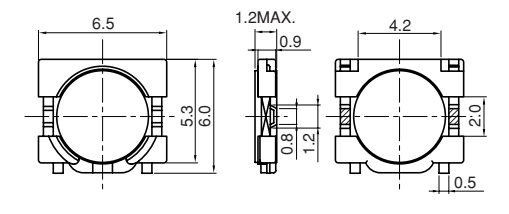

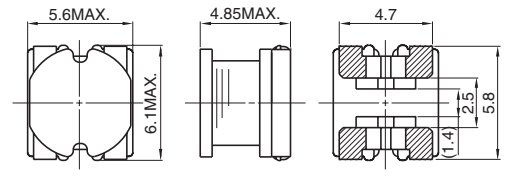

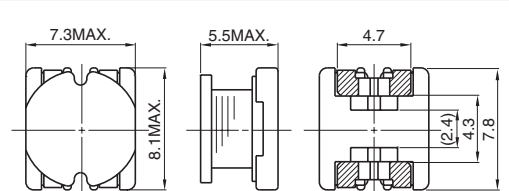

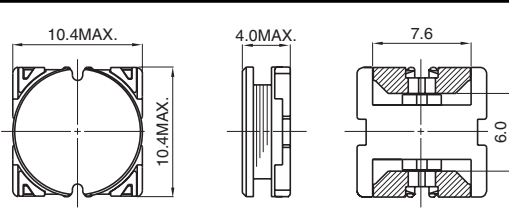



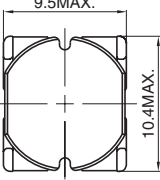
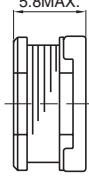
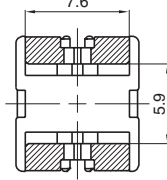

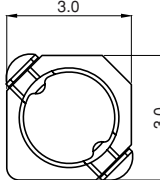
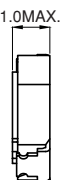
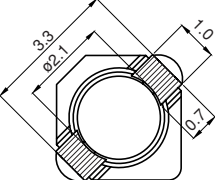

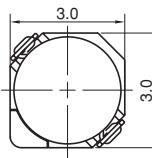

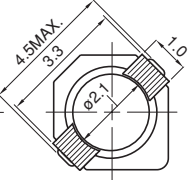

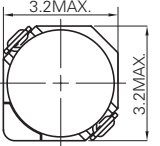

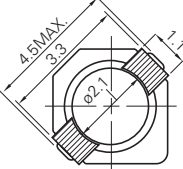
POWER INDUCTORS

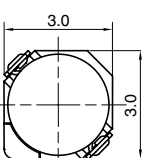
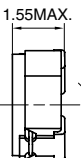
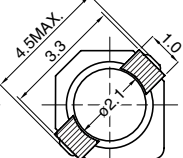
TYPE	DIMENSIONS(mm)	CONSTRUCTION	SPECIFICATIONS
CMD4D06 		I	Inductance : 2.2μH – 47μH D.C.R. : 116mΩ – 2.84Ω Rated Current : 180mA – 950mA
CMD4D08 		I	Inductance : 3.3μH – 100μH D.C.R. : 160mΩ – 3.3Ω Saturation Rated Current : 210mA – 1.2A Temperature Rise Rated Current : 170mA – 850mA
CMD4D11 		I	Inductance : 2.2μH – 47μH D.C.R. : 116mΩ – 2.84Ω Rated Current : 180mA – 950mA
CMD4D13 		I	Inductance : 3.3μH – 150μH D.C.R. : 160mΩ – 5.36Ω Saturation Rated Current : 180mA – 1.2A Temperature Rise Rated Current : 130mA – 850mA
CMD5D11 		I	Inductance : 3.3μH – 100μH D.C.R. : 109mΩ – 2.8Ω Saturation Rated Current : 200mA – 940mA Temperature Rise Rated Current : 200mA – 1.16A
CMD5D13 		I	Inductance : 3.3μH – 47μH D.C.R. : 81mΩ – 875mΩ Saturation Rated Current : 550mA – 1.9A Temperature Rise Rated Current : 350mA – 1.25A
CMD6D11B 		I	Inductance : 4.7μH – 150μH D.C.R. : 100mΩ – 3.1Ω Saturation Rated Current : 210mA – 1.3A Temperature Rise Rated Current : 180mA – 1.4A
CDC4D20   		I	Inductance : 100μH – 4.7mH D.C.R. : 1.77Ω – 72.1Ω Rated Current : 35mA – 230mA

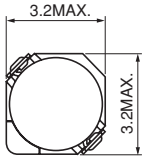
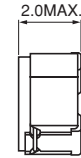
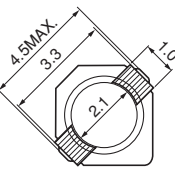

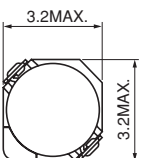
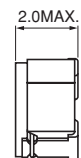
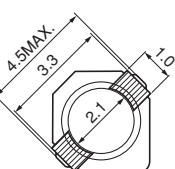

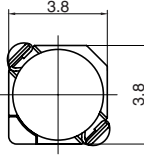
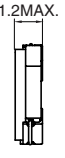
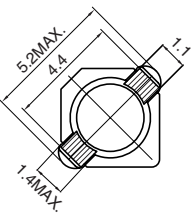





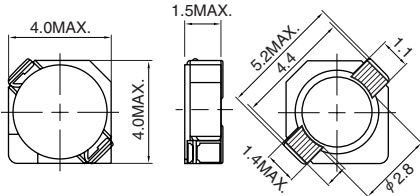

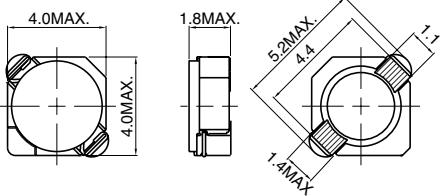

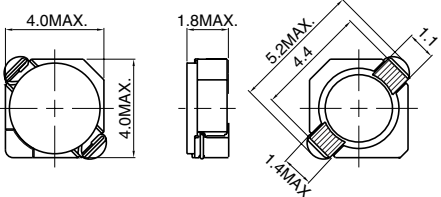

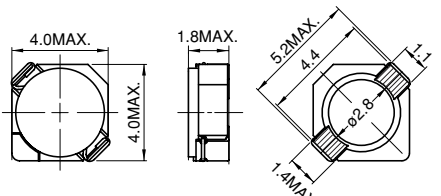
POWER INDUCTORS

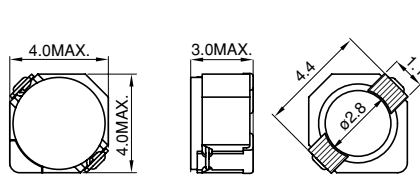
TYPE	DIMENSIONS (mm)	CONSTRUCTION	SPECIFICATIONS
CDC5D23	 	I	Inductance : 2.2μH – 270μH D.C.R. : 39mΩ – 2.73Ω Rated Current : 190mA – 2.16A
CR32	 	I	Inductance : 10μH – 390μH D.C.R. : 230mΩ – 7.8Ω Rated Current : 115mA – 760mA
CR43	 	I	Inductance : 1.0μH – 68μH D.C.R. : 48.7mΩ – 1.12Ω Rated Current : 370mA – 2.56A
CR5D11	 	I	Inductance : 1.0μH – 33μH D.C.R. : 40mΩ – 784mΩ Saturation Rated Current : 400mA – 2.2A Temperature Rise Current (Typ) : 450mA – 2.8A
CR54	 	I	Inductance : 2.2μH – 220μH D.C.R. : 23.4mΩ – 1.57Ω Rated Current : 350mA – 3.84A
CR75	 	I	Inductance : 1.2μH – 470μH D.C.R. : 15.6mΩ – 1.96Ω Rated Current : 340mA – 6.0A
CR10D37	 	I	Inductance : 2.7μH – 680μH D.C.R. : 34.5mΩ – 2.55Ω Saturation Rated Current : 350mA – 5.7A Temperature Rise Rated Current : 330mA – 2.65A

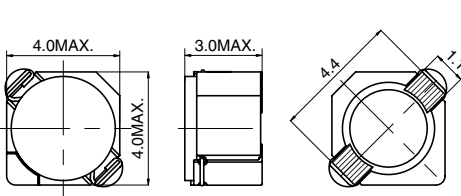

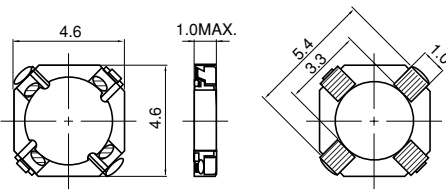

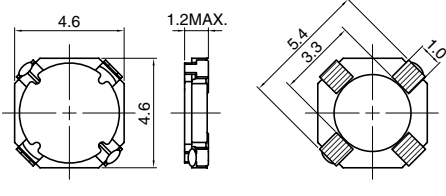





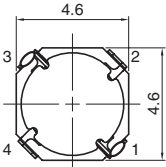
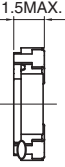
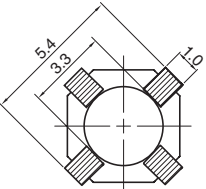

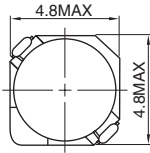
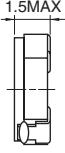
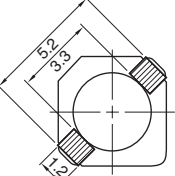

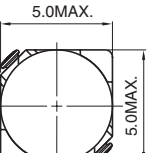
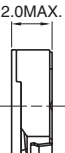
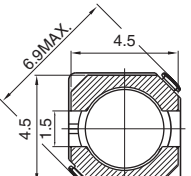

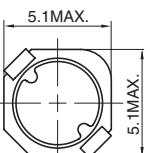
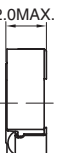
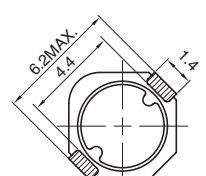

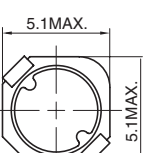
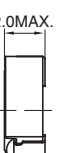
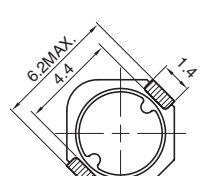
POWER INDUCTORS

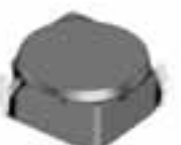
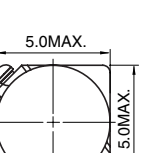
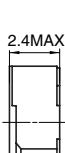
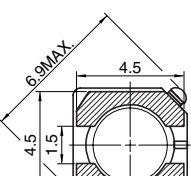

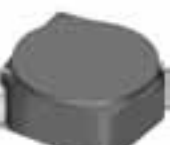
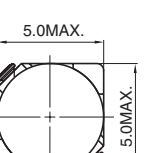
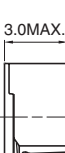
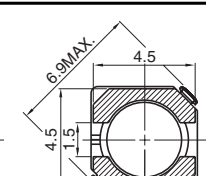

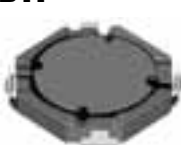
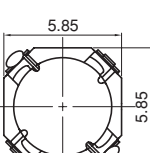

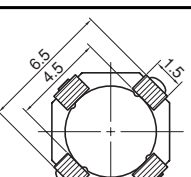



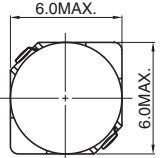

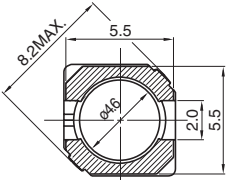

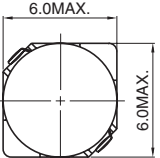

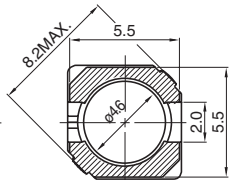

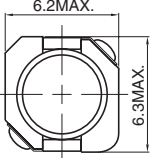
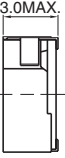
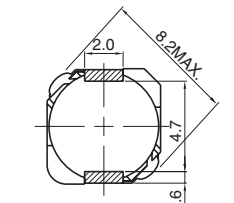

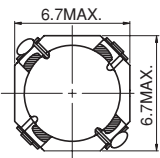

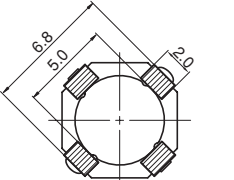

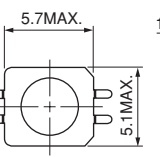
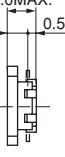
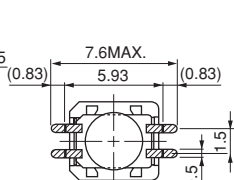
TYPE	DIMENSIONS (mm)			CONSTRUCTION	SPECIFICATIONS
CR105 	 9.5MAX. 10.4MAX.	 5.8MAX.	 7.6 5.9		Inductance : 1.8 μ H – 820 μ H D.C.R. : 13.0m Ω – 2.55 Ω Rated Current : 240mA – 6.0A
CDRH2D09 	 3.0 3.0	 1.0MAX.	 3.3 ϕ 2.1 1.0 0.7		Inductance : 1.2 μ H – 10 μ H D.C.R. : 97.5m Ω – 537.5m Ω Saturation Rated Current : 280mA – 800mA Temperature Rise Current (Typ) : 420mA – 1.24A
CDRH2D11 	 3.0 3.0	 1.2MAX.	 4.5MAX. 3.3 1.0 ϕ 2.1		Inductance : 1.5 μ H – 10 μ H D.C.R. : 68m Ω – 400m Ω Saturation Rated Current : 350mA – 900mA Temperature Rise Current (Typ) : 650mA – 1.48A
CDRH2D11/HP 	 3.2MAX. 3.2MAX.	 1.2MAX.	 4.5MAX. 3.3 1.1 ϕ 2.1		Inductance : 1.5 μ H – 10 μ H D.C.R. : 80m Ω – 559m Ω Saturation Rated Current : 520mA – 1.35A Temperature Rise Current (Typ) : 520mA – 1.6A
CDRH2D14 	 3.0 3.0	 1.55MAX.	 4.5MAX. 3.3 1.0 ϕ 2.1		Inductance : 1.5 μ H – 12 μ H D.C.R. : 63m Ω – 394m Ω Saturation Rated Current : 620mA – 1.8A Temperature Rise Current (Typ) : 640mA – 2.0A
CDRH2D18/LD 	 3.2MAX. 3.2MAX.	 2.0MAX.	 4.5MAX. 3.3 1.0 2.1		Inductance : 2.2 μ H – 47 μ H D.C.R. : 41m Ω – 660m Ω Saturation Rated Current : 200mA – 850mA Temperature Rise Current (Typ) : 480mA – 2.3A
CDRH2D18/HP 	 3.2MAX. 3.2MAX.	 2.0MAX.	 4.5MAX. 3.3 1.0 2.1		Inductance : 1.7 μ H – 15 μ H D.C.R. : 44m Ω – 345m Ω Saturation Rated Current : 700mA – 1.85A Temperature Rise Current (Typ) : 640mA – 2.2A
CDRH3D11 	 3.8 3.8	 1.2MAX.	 5.2MAX. 4.4 1.4MAX. 1.1		Inductance : 2.7 μ H – 39 μ H D.C.R. : 84.5m Ω – 1.02 Ω Saturation Rated Current : 140mA – 530mA Temperature Rise Current (Typ) : 400mA – 1.82A

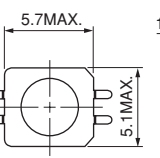
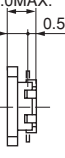
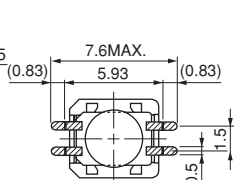
POWER INDUCTORS

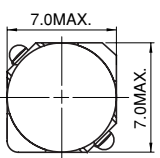
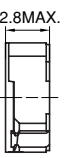
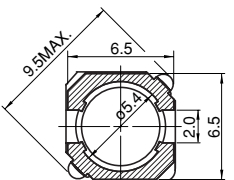

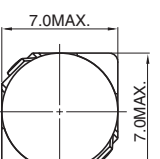

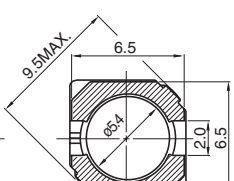





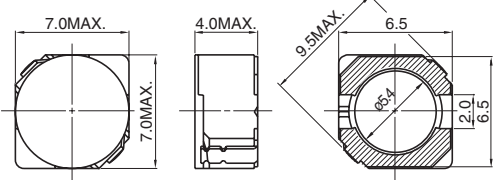

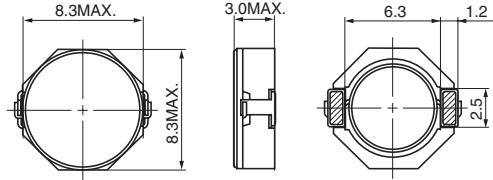

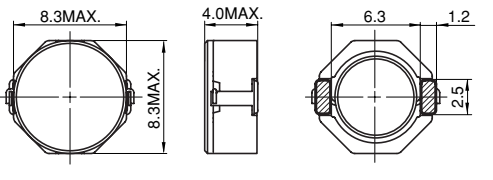

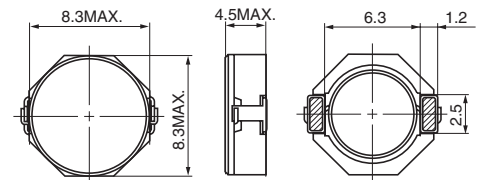
TYPE	DIMENSIONS(mm)	CONSTRUCTION	SPECIFICATIONS
CDRH3D14/HP 			Inductance : 1.5 μ H – 22 μ H D.C.R. : 76m Ω – 830m Ω Saturation Rated Current : 650mA – 2.6A Temperature Rise Current (Typ) : 480mA – 1.85A
CDRH3D16 			Inductance : 1.5 μ H – 33 μ H D.C.R. : 52m Ω – 675m Ω Rated Current : 320mA – 1.55A
CDRH3D16/LD 			Inductance : 3.3 μ H – 47 μ H D.C.R. : 66m Ω – 775m Ω Saturation Rated Current : 210mA – 800mA Temperature Rise Current (Typ) : 450mA – 2.0A
CDRH3D16/HP 			Inductance : 1.7 μ H – 33 μ H D.C.R. : 51m Ω – 870m Ω Saturation Rated Current : 460mA – 2.0A Temperature Rise Current (Typ) : 410mA – 2.4A
CDRH3D28 			Inductance : 3.3 μ H – 47 μ H D.C.R. : 72.1m Ω – 599m Ω Saturation Rated Current : 480mA – 2.0A Temperature Rise Current (Typ) : 560mA – 1.85A
CDRH3D28/LD 			Inductance : 10 μ H – 220 μ H D.C.R. : 95m Ω – 1.27 Ω Saturation Rated Current : 116mA – 500mA Temperature Rise Current (Typ) : 360mA – 1.52A
CLS4D09 			Inductance : 4.7 μ H – 22 μ H D.C.R. : 185m Ω – 910m Ω Saturation Rated Current : 350mA – 800mA Temperature Rise Rated Current : 300mA – 750mA
CLS4D11 			Inductance : 3.3 μ H – 33 μ H D.C.R. : 120m Ω – 1.1 Ω Rated Current : 300mA – 1.0A

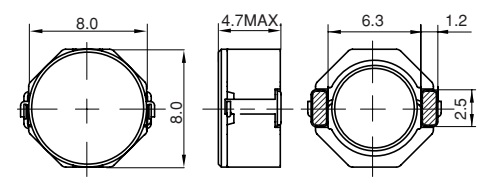

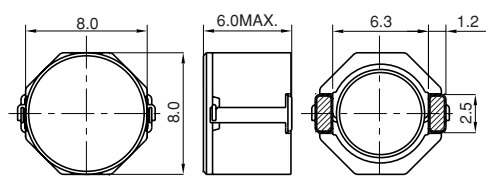

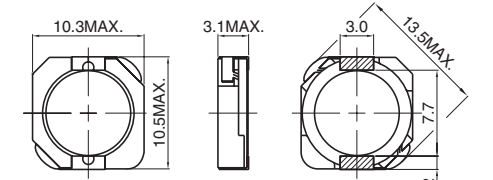

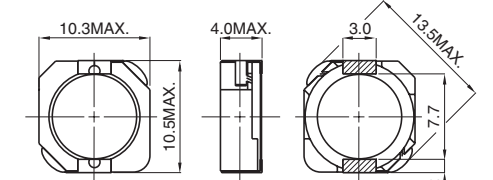



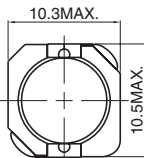
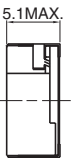
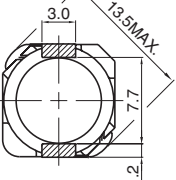

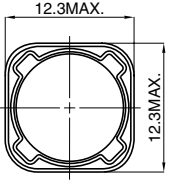
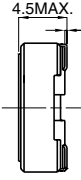
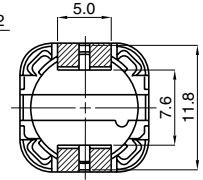

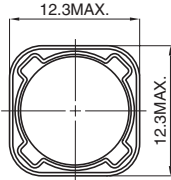
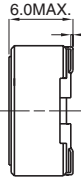
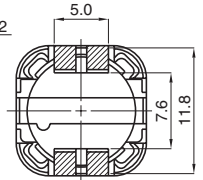

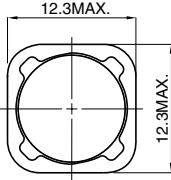

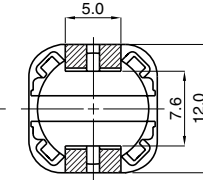

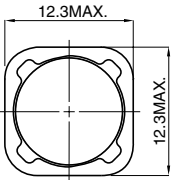

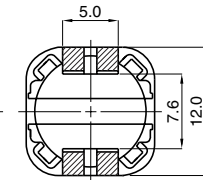
POWER INDUCTORS

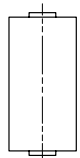
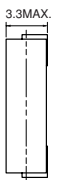
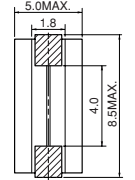
TYPE	DIMENSIONS (mm)			CONSTRUCTION	SPECIFICATIONS
CLS4D14 					Inductance : 4.7 μ H – 47 μ H D.C.R. : 110m Ω – 830m Ω Saturation Rated Current : 300mA – 900mA Temperature Rise Rated Current : 330mA – 1.0A
CDRH4D14/HP 					Inductance : 4.7 μ H – 10 μ H D.C.R. : 140m Ω – 280m Ω Saturation Rated Current : 950mA – 1.4A Temperature Rise Rated Current : 750mA – 1.1A
CDRH4D18 					Inductance : 1.0 μ H – 180 μ H D.C.R. : 45m Ω – 4.0 Ω Rated Current : 140mA – 1.72A
CDRH4D18C 					Inductance : 1.1 μ H – 100 μ H D.C.R. : 29m Ω – 1.51 Ω Rated Current : 250mA – 2.4A
CDRH4D18C/LD 					Inductance : 1.1 μ H – 100 μ H D.C.R. : 24m Ω – 962m Ω Saturation Rated Current : 200mA – 2.1A Temperature Rise Rated Current : 350mA – 3.5A
CDRH4D22 					Inductance : 1.5 μ H – 150 μ H D.C.R. : 18.3m Ω – 1.35 Ω Saturation Rated Current : 210mA – 2.0A Temperature Rise Current (Typ) : 470mA – 4.2A
CDRH4D28 					Inductance : 1.2 μ H – 180 μ H D.C.R. : 23.6m Ω – 1.54 Ω Rated Current : 220mA – 2.56A
CLS5D11 					Inductance : 4.7 μ H – 47 μ H D.C.R. : 120m Ω – 930m Ω Saturation Rated Current : 380mA – 1.1A Temperature Rise Rated Current : 350mA – 1.1A

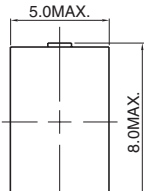

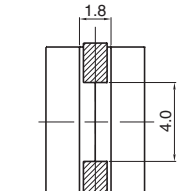

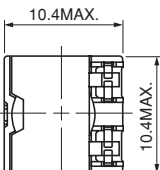
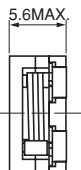
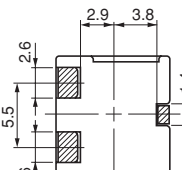





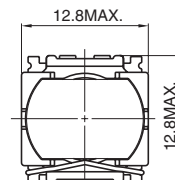
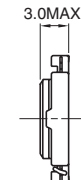
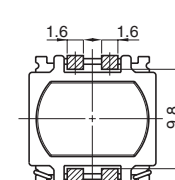

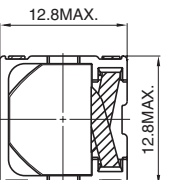

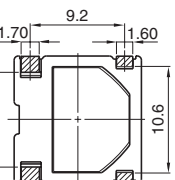

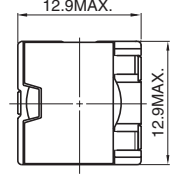
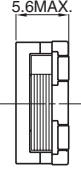
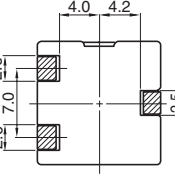
POWER INDUCTORS					
TYPE	DIMENSIONS (mm)			CONSTRUCTION	SPECIFICATIONS
CDRH5D18 					Inductance : 4.1 μ H – 100 μ H D.C.R. : 57m Ω – 1.2 Ω Rated Current : 360mA – 1.95A
CDRH5D28 					Inductance : 2.5 μ H – 100 μ H D.C.R. : 18m Ω – 520m Ω Rated Current : 420mA – 2.6A
CDRH5D28R 					Inductance : 2.5 μ H – 100 μ H D.C.R. : 17.6m Ω – 520m Ω Rated Current : 400mA – 2.6A
CDRH6D12 					Inductance : 1.0 μ H – 68 μ H D.C.R. : 37.5m Ω – 920m Ω Saturation Rated Current : 450mA – 3.5A Temperature Rise Current (Typ) : 400mA – 2.8A
CLQ61 					Inductance : 2.2 μ H – 330 μ H D.C.R. : 81m Ω – 7.15 Ω Rated Current : 70mA – 1.36A
CLQ61B 					Inductance : 2.2 μ H – 330 μ H D.C.R. : 81m Ω – 7.15 Ω Rated Current : 70mA – 1.36A
CDRH6D26 					Inductance : 2.2 μ H – 100 μ H D.C.R. : 22m Ω – 560m Ω Rated Current : 500mA – 3.2A
CDRH6D28 					Inductance : 3.0 μ H – 100 μ H D.C.R. : 24m Ω – 535m Ω Rated Current : 540mA – 3.0A

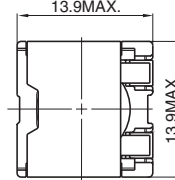
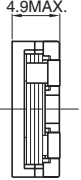
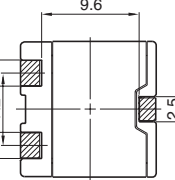
POWER INDUCTORS

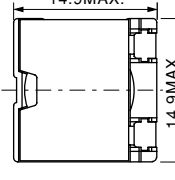
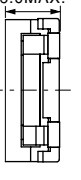
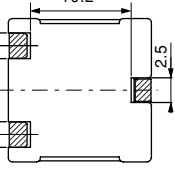

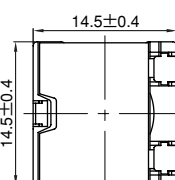
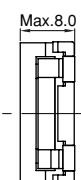
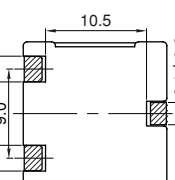

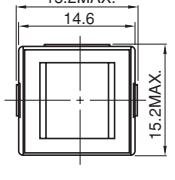
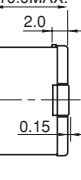
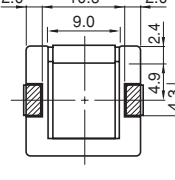





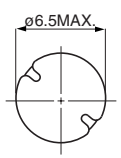
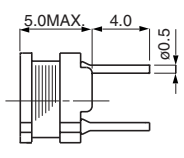
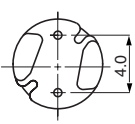

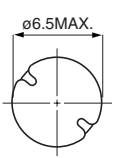
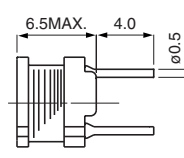
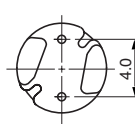

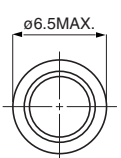
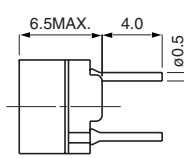
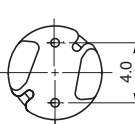
TYPE	DIMENSIONS(mm)	CONSTRUCTION	SPECIFICATIONS
CDRH6D38 			Inductance : 3.3 μ H – 100 μ H D.C.R. : 20m Ω – 358m Ω Rated Current : 650mA – 3.5A
CDRH8D28 			Inductance : 2.5 μ H – 100 μ H D.C.R. : 15.6m Ω – 430m Ω Saturation Rated Current : 750mA – 4.5A Temperature Rise Current (Typ) : 800mA – 6.4A
CDRH8D38 			Inductance : 1.8 μ H – 100 μ H D.C.R. : 15.6m Ω – 410m Ω Saturation Rated Current : 1.05A – 7.0A Temperature Rise Current (Typ) : 880mA – 6.8A
CDRH8D43 			Inductance : 2.0 μ H – 100 μ H D.C.R. : 14m Ω – 360m Ω Saturation Rated Current : 1.3A – 7.0A Temperature Rise Rated Current : 800mA – 5.5A
CDRH8D43/HP 			Inductance : 1.2 μ H – 68 μ H D.C.R. : 16.5m Ω – 363m Ω Saturation Rated Current : 1.6A – 12.6A Temperature Rise Current (Typ) : 800mA – 5.6A
CDRH8D58/LD 			Inductance : 2.8 μ H – 100 μ H D.C.R. : 15m Ω – 175m Ω Saturation Rated Current : 800mA – 4.7A Temperature Rise Current (Typ) : 1.4A – 6.9A
CDRH103R 			Inductance : 0.8 μ H – 150 μ H D.C.R. : 5.7m Ω – 871m Ω Saturation Rated Current : 840mA – 11.2A Temperature Rise Rated Current : 510mA – 8.3A
CDRH104R 			Inductance : 1.5 μ H – 330 μ H D.C.R. : 8.1m Ω – 1.09 Ω Saturation Rated Current : 700mA – 10.0A Temperature Rise Rated Current : 520mA – 6.5A

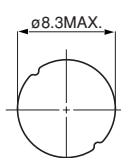
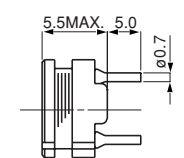
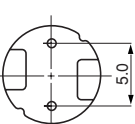
POWER INDUCTORS					
TYPE	DIMENSIONS(mm)			CONSTRUCTION	SPECIFICATIONS
CDRH105R 					Inductance : 0.8 μ H – 1.0mH D.C.R. : 4.3m Ω – 2.0 Ω Saturation Rated Current : 420mA – 9.5A Temperature Rise Rated Current : 480mA – 13.5A
CDRH124 					Inductance : 3.9 μ H – 330 μ H D.C.R. : 15m Ω – 990m Ω Rated Current : 500mA – 6.5A
CDRH125 					Inductance : 1.3 μ H – 1.0mH D.C.R. : 12m Ω – 1.53 Ω Rated Current : 400mA – 8.0A
CDRH127 					Inductance : 1.2 μ H – 1.0mH D.C.R. : 7.0m Ω – 1.82 Ω Rated Current : 550mA – 9.8A
CDRH127/LD 					Inductance : 1.0 μ H – 1.0mH D.C.R. : 6.5m Ω – 1.50 Ω Rated Current : 700mA – 14.0A
CDBM73MN 					Inductance : 100 μ H D.C.R. : Max 0.9m Ω Saturation Rated Current : 24.0A Temperature Rise Current (Typ) : 22.5A
CDBM7D28 					Inductance : 80nH – 120nH D.C.R. : Max. 1.7m Ω Rated Current : 15.0A
CDEP105 					Inductance : 0.15 μ H – 8.8 μ H D.C.R. : 1.7m Ω – 23.8m Ω Saturation Rated Current : 4.8A – 55.0A Temperature Rise Current (Typ) : 4.9A – 19.0A

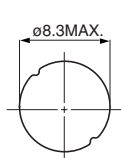
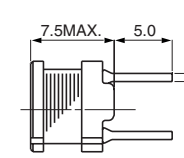
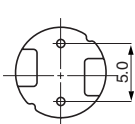

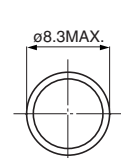
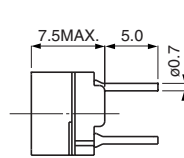
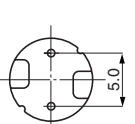

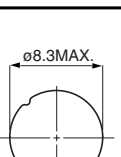
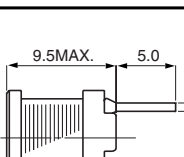
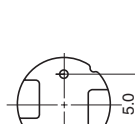

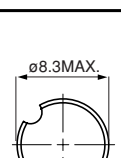
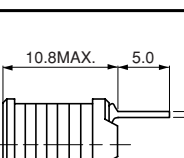
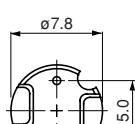



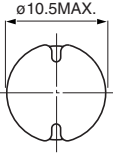
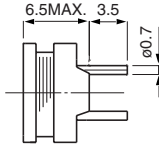
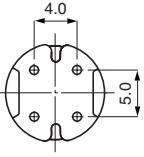

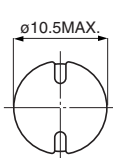
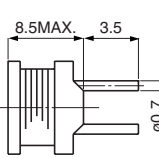
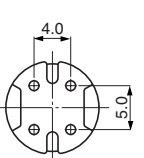

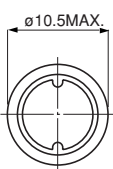
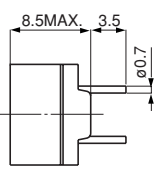
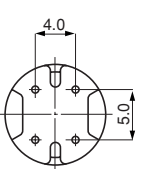

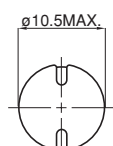
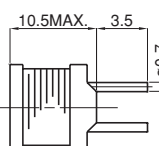
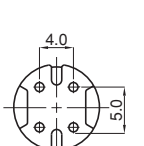
POWER INDUCTORS

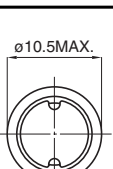
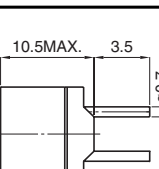
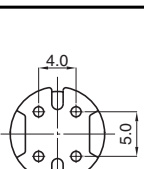
TYPE	DIMENSIONS(mm)			CONSTRUCTION	SPECIFICATIONS
CEI122(H) 					Inductance : 0.7μH – 22μH D.C.R. : 10.7mΩ – 85.0mΩ Saturation Rated Current : 2.3A – 17.0A Temperature Rise Current (Typ) : 2.3A – 6.6A
CEP123 					Inductance : 1.2μH – 8.0μH D.C.R. : 5.83mΩ – 23.0mΩ Rated Current : 4.0A – 10.0A
CEP125(H,U) 					Inductance : 0.35μH – 10.0μH D.C.R. : 1.5mΩ – 13.5mΩ Saturation Rated Current : 5.0A – 35.0A Temperature Rise Current (Typ) : 7.6A – 19.5A
CDEP134(H) 					Inductance : 0.3μH – 8.0μH D.C.R. : 1.9mΩ – 18.4mΩ Saturation Rated Current : 7.2A – 35.0A Temperature Rise Current (Typ) : 6.5A – 18.5A
CDEP145 					Inductance : 0.56μH – 6.1μH D.C.R. : 1.7mΩ – 10.8mΩ Saturation Rated Current : 10.4A – 36.0A Temperature Rise Current (Typ) : 9.5A – 23.0A
CDEP147 					Inductance : 0.7μH – 9.5μH D.C.R. : 1.86mΩ – 11.23mΩ Saturation Rated Current : 11.2A – 36.0A Temperature Rise Current (Typ) : 8.5A – 21.0A
CDEP149(H) 					Inductance : 0.45μH – 3.0μH D.C.R. : 1.1mΩ – 2.3mΩ Saturation Rated Current : 12.4A – 32.0A Temperature Rise Current (Typ) : 28.0A – 35.0A

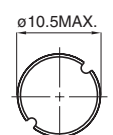
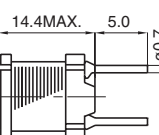
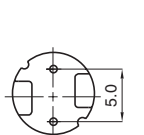

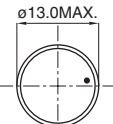
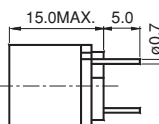
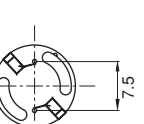
POWER INDUCTORS

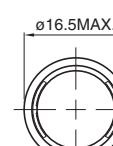
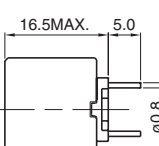
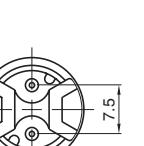
TYPE	DIMENSIONS(mm)			CONSTRUCTION	SPECIFICATIONS	
RCH-654					I	Inductance : 1.0 μ H – 1.0mH D.C.R. : 29m Ω – 7.06 Ω Rated Current : 130mA – 3.0A
RCH-664					I	Inductance : 1.0 μ H – 1.0mH D.C.R. : 18.3m Ω – 4.45 Ω Rated Current : 190mA – 4.0A
RCR-664D					I	Inductance : 2.7 μ H – 1.0mH D.C.R. : 42m Ω – 5.56 Ω Rated Current : 140mA – 2.42A
RCH-855					I	Inductance : 2.5 μ H – 10mH D.C.R. : 23m Ω – 55.7 Ω Saturation Rated Current : 81mA – 4.5A Temperature Rise Rated Current : 37mA – 3.1A
RCH-875					I	Inductance : 2.2 μ H – 10mH D.C.R. : 13.7m Ω – 33.0 Ω Saturation Rated Current : 84mA – 5.8A Temperature Rise Rated Current : 54mA – 3.0A
RCR-875D					I	Inductance : 1.2 μ H – 10mH D.C.R. : 18m Ω – 35.0 Ω Rated Current : 74mA – 4.14A
RCH-895					I	Inductance : 2.5 μ H – 47mH D.C.R. : 13.7m Ω – 96.4 Ω Saturation Rated Current : 38mA – 5.0A Temperature Rise Rated Current : 31mA – 3.2A
RCH8011					I	Inductance : 10 μ H – 1.0mH D.C.R. : 35m Ω – 1.92 Ω Saturation Rated Current : 490mA – 4.4A Temperature Rise Current (Typ) : 470mA – 4.1A

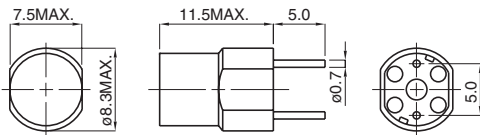

POWER INDUCTORS

TYPE	DIMENSIONS(mm)			CONSTRUCTION	SPECIFICATIONS
RCH-106 					Inductance : 1.0 μ H – 1.0mH D.C.R. : 5.0m Ω – 3.2 Ω Rated Current : 360mA – 9.3A
RCH-108 					Inductance : 2.2 μ H – 1.0mH D.C.R. : 8.5m Ω – 2.1 Ω Rated Current : 450mA – 7.9A
RCR-108D 					Inductance : 1.0 μ H – 1.0mH D.C.R. : 6.5m Ω – 2.3 Ω Rated Current : 280mA – 9.15A
RCH-110 					Inductance : 10 μ H – 1.0mH D.C.R. : 22m Ω – 1.7 Ω Rated Current : 530mA – 5.3A
RCR-110D 					Inductance : 10 μ H – 1.0mH D.C.R. : 23m Ω – 1.5 Ω Rated Current : 350mA – 3.51A
RCH-114 					Inductance : 6.3 μ H – 39mH D.C.R. : 26m Ω – 58 Ω Rated Current : 90mA – 4.3A
RP1315 					Inductance : 10 μ H – 33 μ H D.C.R. : 19m Ω – 70m Ω Saturation Rated Current : 4.5A – 8.1A Temperature Rise Rated Current : 2.3A – 4.5A
RCR1616 					Inductance : 4.7 μ H – 1.0mH D.C.R. : 6.7m Ω – 665m Ω Saturation Rated Current : 850mA – 12.6A Temperature Rise Rated Current : 930mA – 9.2A

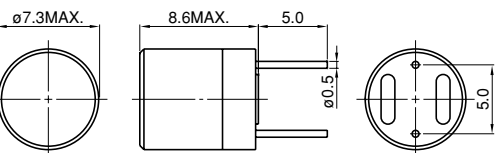

FIXED INDUCTORS

TYPE	DIMENSIONS(mm)	CONSTRUCTION	SPECIFICATIONS
RC-875 	 <p>7.5MAX. 11.5MAX. 5.0 $\phi 8.3$MAX. $\phi 0.7$ 5.0</p>		Inductance : Max. 47mH Operating Freq. : Max. 1MHz

Molded case type
 Excellent maximum allowable DC current characteristics

RX-7P 	 <p>$\phi 7.3$MAX. 8.6MAX. 5.0 $\phi 0.5$ 5.0</p>		Inductance : Max. 6.8mH Operating Freq. : Max. 1MHz
--	---	--	--

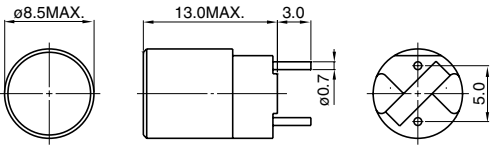
Magnetically shielded type

RX-8P 	 <p>$\phi 8.5$MAX. 13.0MAX. 3.0 $\phi 0.7$ 5.0</p>		Inductance : Max. 33mH Operating Freq. : Max. 1MHz
---	---	--	---

Magnetically shielded type

High Reliability Inverter Transformers

OUTLINE

The leakage transformer has a special core that allows for co-axial winding.
 Suitable for large LCD panel, and complies to customer needs of high open voltage and high lamp wattage.
 Inverter transformer corresponding to multiple CCFL lamps driving for large LCD TV application
 It is possible to drive 2 CCFLs in 1 transformer. No ballast capacitor is required

INVERTER TRANSFORMERS

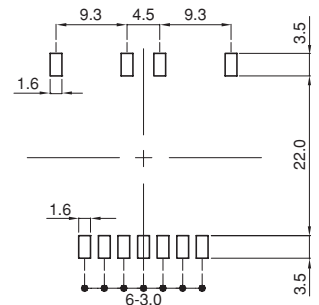
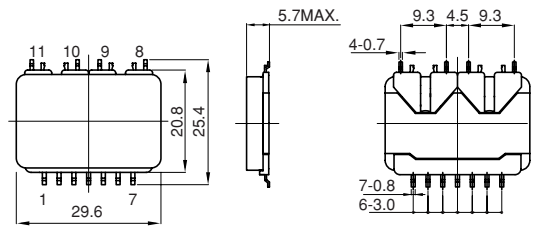
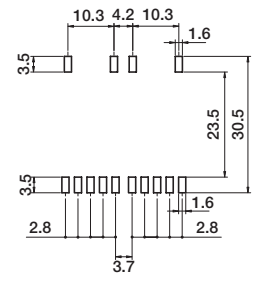
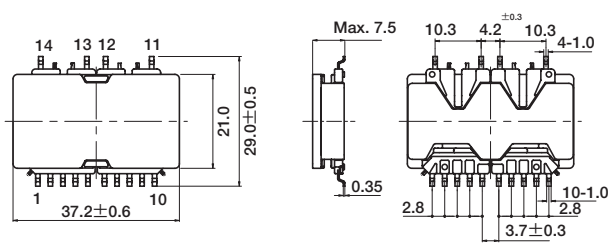
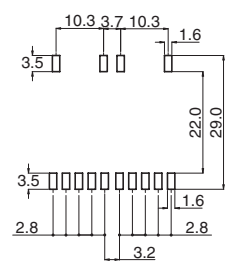
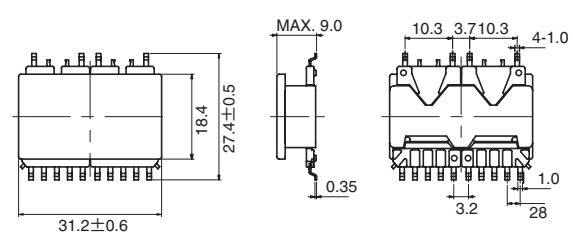
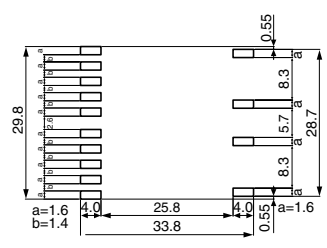
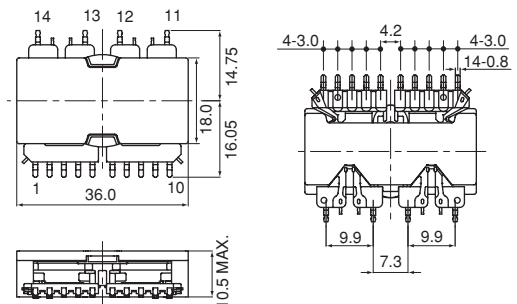
CPUDL294
● DIMENSIONS(mm)
● LAND PATTERNS (mm)

CEIDL318
● DIMENSIONS(mm)
● LAND PATTERNS (mm)

CEIDL377
● Dimensions(mm)
● Recommended land patterns(mm)

CEIDL369
● DIMENSIONS(mm)
● LAND PATTERNS (mm)

High Reliability Inverter Transformers

EIDL369



PROVISIONAL

● DIMENSIONS (mm)

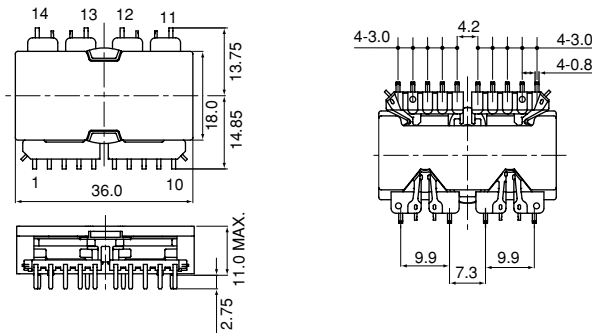

■ CHARACTERISTICS

- Unique shielding reduces noise emissions.
- Leakage transformer types are magnetically shielded.
- No ballast capacitor is required due to leakage structure of the transformer.
- High temperature reflow soldering is permitted. (Pb free)

◆ APPLICATION

1. Large LCD TV
2. LCD monitor

● Schematic

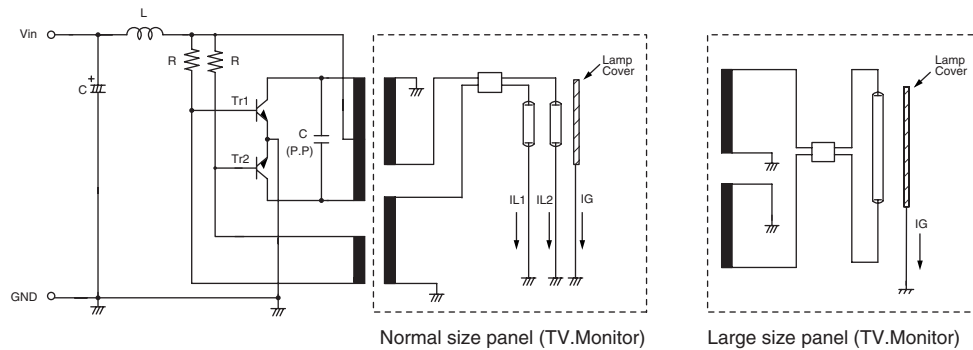

● Schematic

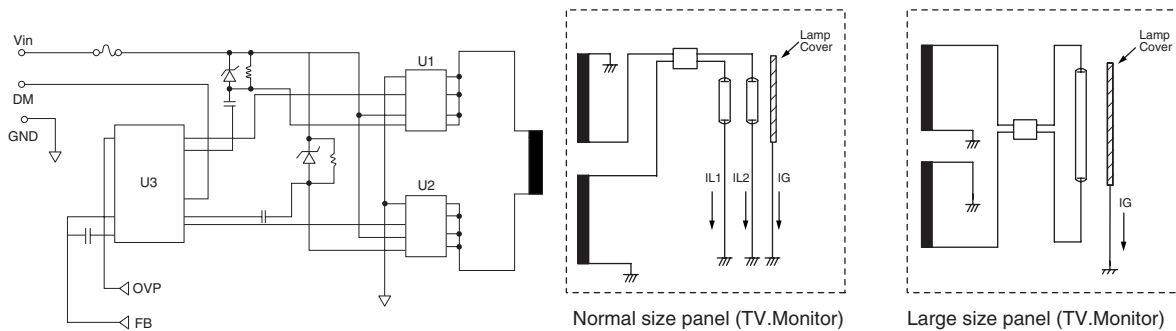

● SPECIFICATIONS

Product Type	Frequency Range	Max. Open Voltage	Max. Lamp Wattage
CPUDL294	35kHz~70kHz	1500Vrms	3W×2
CEIDL318	35kHz~65kHz	1500Vrms (1800Vrms, 3sec)	7.5W×2
CEIDL377	35kHz~65kHz	1500Vrms (1800Vrms, 3sec)	7.5W×2
CEIDL369	40kHz~65kHz	1600Vrms (2000Vrms, 3sec)	10W×2
EIDL369	40kHz~65kHz	1600Vrms (2000Vrms, 3sec)	10W×2

About CPUDL294, CEIDL369, EIDL369

※This specification might be changed without notice due to under developing and improving. Thank you for your understanding.

High Reliability Inverter Transformers

OUTLINE

Slim type Inverter transformer corresponding to multiple CCFL lamps driving for large LCD TV application
 Designed secondary winding for out put voltage check
 High efficiency suitable for IC controlled type circuit

CIUH11D66
● DIMENSIONS(mm)

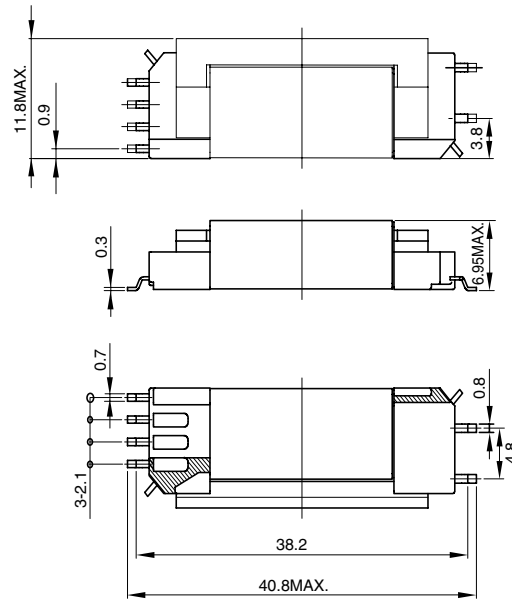
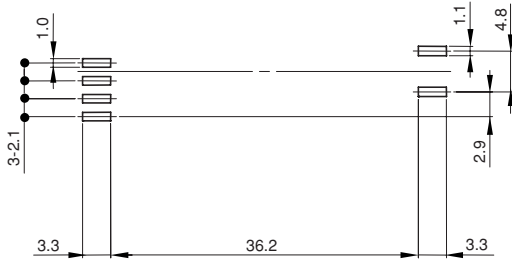
● LAND PATTERNS(mm)

● SPECIFICATIONS

Frequency Range	50kHz~300kHz
Max. Open Voltage	1600Vrms
Max. Lamp Wattage	8.0W

INVERTER TRANSFORMERS

NEW PRODUCTS

INVERTER UNIT

OUTLINE

1. Inverter unit for powering CCFL in 27" TV application
2. Line communication type circuitry
3. Polyphase circuitry

IV120307

NEW

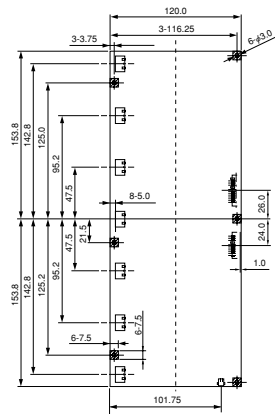

COMPONENT SIDE

DIMENSIONS (mm)

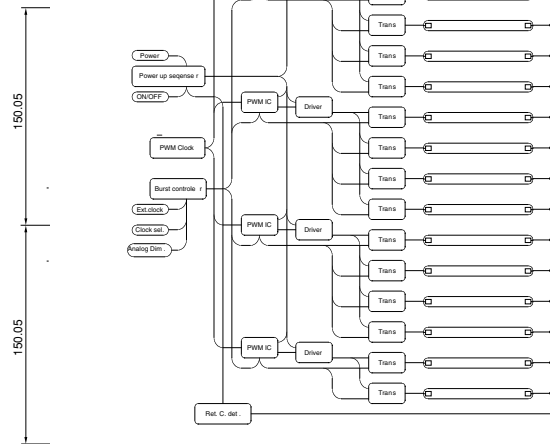

MEASUREMENT CIRCUIT DIAGRAM

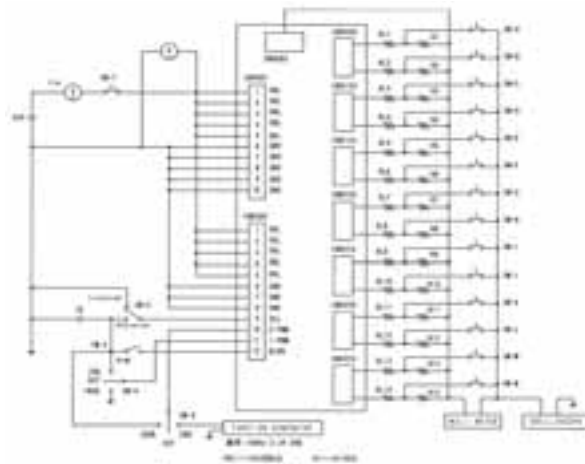











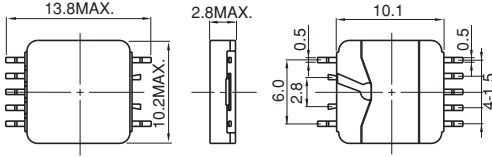

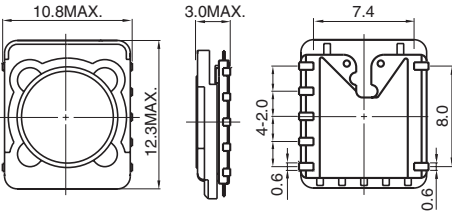

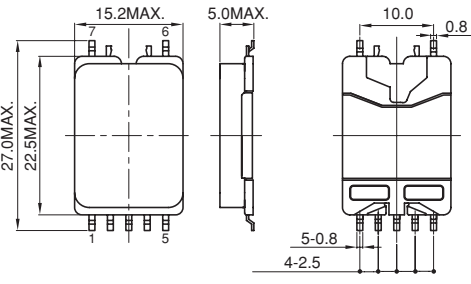
ELECTRICAL SPECIFICATIONS

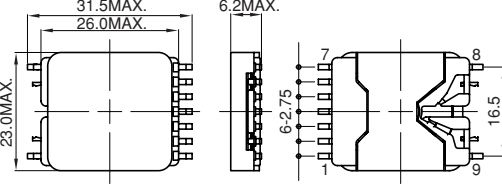
Parameter	Symbol	Condition	Specifications			Unit
			min.	typ.	max.	
Input Voltage	Vin	Vin=24.0V±0.1V	21.6	24.0	26.4	V
Input Current	Iin	Vin=24.0V±0.1V	—	—	5.91	A
Frequency	Fosc	Vin=24.0V±0.1V	54.0	56.0	58.0	kHz
Lamp Current (Current/a Lamp)	IL	Vin=24.0V±0.1V Duty Ratio=100%	4.4	4.7	5.0	mArms

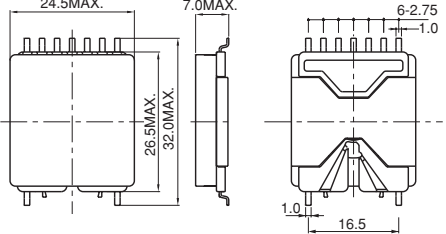
FEATURES

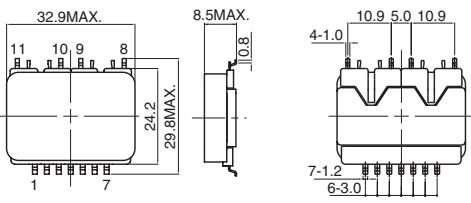
1. Lead-free available
2. For light adjustment, both PWM and voltage methods are used.
3. Effective protection functionality: Excessive-voltage protection and lamp-open detection circuitry.

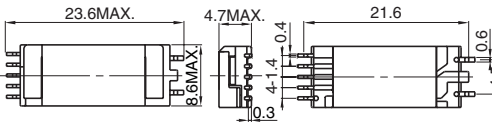
INVERTER TRANSFORMERS

TYPE	DIMENSIONS(mm)	CONSTRUCTION	SPECIFICATIONS
CPU9D25 			Operating Freq. : Max. 140kHz Max. Open Voltage : 750Vrms Max. Lamp Wattage : 1.5W
CLQ122 			Operating Freq. : Max. 140kHz Max. Open Voltage : 750Vrms Max. Lamp Wattage : 1.2W
CPU144C  PROVISIONAL			Operating Freq. : Max. 100kHz Max. Open Voltage : 1,500Vrms Max. Lamp Wattage : 4W
GPU215 			Operating Freq. : Max. 80kHz Max. Open Voltage : 1,800Vrms Max. Lamp Wattage : 6W
CPUL236 			Operating Freq. : Max. 100kHz Max. Open Voltage : 1,500Vrms Max. Lamp Wattage : 7.5W
CPUDL328 			Operating Freq. : Max. 65kHz Max. Open Voltage : 1,500Vrms Max. Lamp Wattage : 6W×2
CIUH84 			Operating Freq. : Max. 300kHz Max. Open Voltage : 1,000Vrms Max. Lamp Wattage : 1.2W









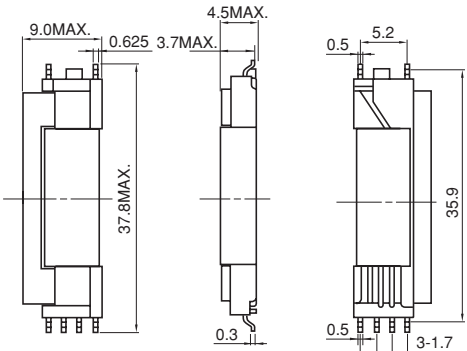

INVERTER TRANSFORMERS

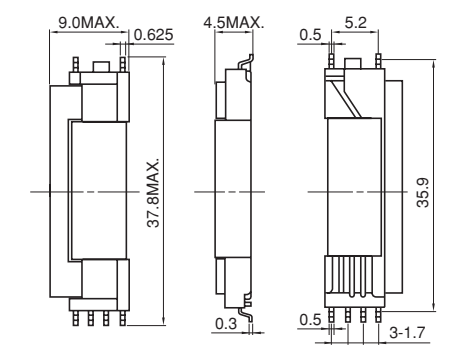
INVERTER TRANSFORMERS

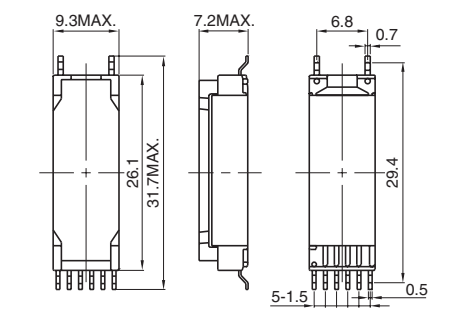
TYPE	DIMENSIONS(mm)	CONSTRUCTION	SPECIFICATIONS
CEPH145B 			Operating Freq. : Max. 300kHz Max. Open Voltage : 1,300Vrms Max. Lamp Wattage : 2.5W
CEPH165 			Operating Freq. : Max. 300kHz Max. Open Voltage : 1,300Vrms Max. Lamp Wattage : 3.0W
CEPH209 			Operating Freq. : Max. 100kHz Max. Open Voltage : 2,000Vrms Max. Lamp Wattage : 10.0W
CEPH249 			Operating Freq. : Max. 100kHz Max. Open Voltage : 2,000Vrms Max. Lamp Wattage : 15.0W
CEPH115 			Operating Freq. : Max. 150kHz Max. Open Voltage : 1,300Vrms Max. Lamp Wattage : 3.0W
CIU7D32 			Operating Freq. : Max. 100kHz Max. Open Voltage : 1,600Vrms Max. Lamp Wattage : 3.5W
CIUH7D45 			Operating Freq. : Max. 200kHz Max. open voltage : 1,600Vrms Max. lamp wattage : 4.0W

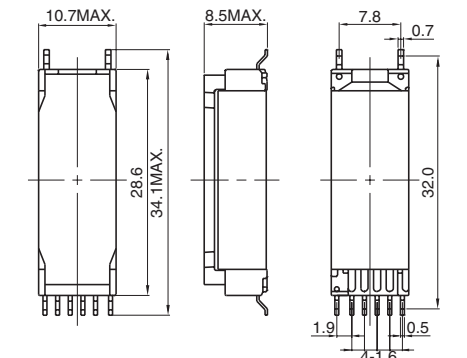

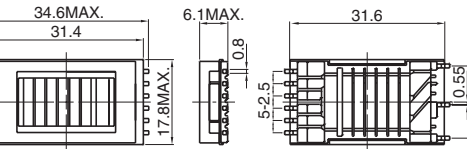







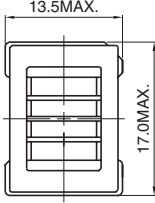
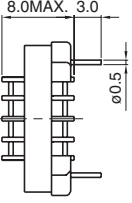
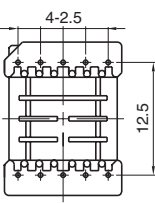

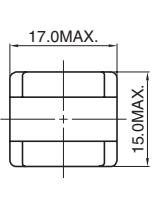
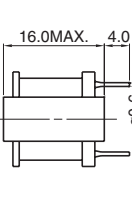
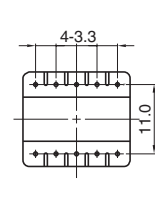
INVERTER TRANSFORMERS

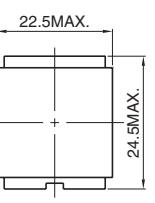
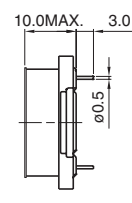
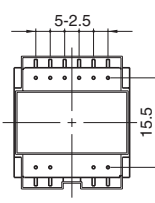
INVERTER TRANSFORMERS

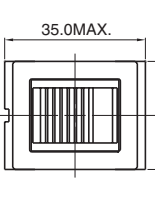
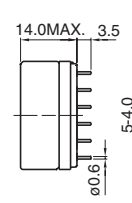
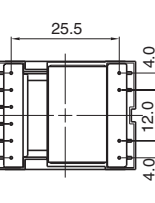
TYPE	DIMENSIONS(mm)	CONSTRUCTION	SPECIFICATIONS
CIUH8D34 			Operating Freq. : Max. 200kHz Max. Open Voltage : 1,600Vrms Max. Lamp Wattage : 3.5W
CIUH8D42 			Operating Freq. : Max. 200kHz Max. Open Voltage : 1,600Vrms Max. Lamp Wattage : 3.5W
CIU86 			Operating Freq. : Max. 200kHz Max. Open Voltage : 1,500Vrms Max. Lamp Wattage : 3.0W
CIU98 			Operating Freq. : Max. 300kHz Max. Open Voltage : 1,800Vrms Max. Lamp Wattage : 6.0W
CI0H175 			Operating Freq. : Max. 150kHz Max. Open Voltage : 1,800Vrms Max. Lamp Wattage : 5.0W

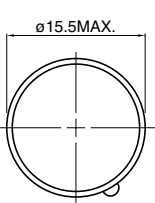
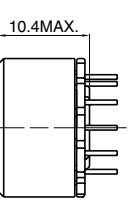
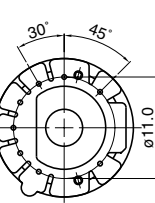
INVERTER TRANSFORMERS

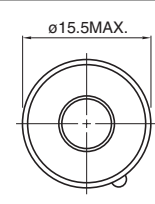
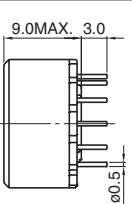
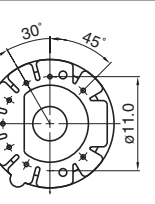
INVERTER TRANSFORMERS

TYPE	DIMENSIONS(mm)			CONSTRUCTION	SPECIFICATIONS
<p>EW-12H</p> 	 <p>13.5MAX. 17.0MAX.</p>	 <p>8.0MAX. 3.0 ø0.5</p>	 <p>4-2.5 12.5</p>		<p>Operating Freq. : Max. 300kHz Max. Open Voltage : 900Vrms Max. Lamp Wattage : 1.7W</p>
<p>SEP-16</p> 	 <p>17.0MAX. 15.0MAX.</p>	 <p>16.0MAX. 4.0 ø0.6</p>	 <p>4-3.3 11.0</p>		<p>Operating Freq. : Max. 300kHz Max. Open Voltage : 1,200Vrms Max. Lamp Wattage : 4.0W</p>
<p>EP208B</p> 	 <p>22.5MAX. 24.5MAX.</p>	 <p>10.0MAX. 3.0 ø0.5</p>	 <p>5-2.5 15.5</p>		<p>Operating Freq. : Max. 300kHz Max. Open Voltage : 1,600Vrms Max. Lamp Wattage : 4.0W</p>
<p>EEH2513</p> 	 <p>35.0MAX. 26.3MAX.</p>	 <p>14.0MAX. 3.5 ø0.6</p>	 <p>25.5 5-4.0 4.0 12.0 4.0</p>		<p>Operating Freq. : Max. 500kHz Max. Open Voltage : 2,200Vrms Max. Lamp Wattage : 15.0W</p>
<p>MC159</p> 	 <p>ø15.5MAX.</p>	 <p>10.4MAX.</p>	 <p>30° 45° ø11.0</p>		<p>Operating Freq. : Max. 100kHz Max. Open Voltage : 900Vrms Max. Lamp Wattage : 1.5W</p>
<p>LC158</p> 	 <p>ø15.5MAX.</p>	 <p>9.0MAX. 3.0 ø0.5</p>	 <p>30° 45° ø11.0</p>		<p>Operating Freq. : Max. 100kHz Max. Open Voltage : 900Vrms Max. Lamp Wattage : 2.5W</p>

Transformer for UP-Down or Up Converter

OUTLINE

This is small size and high efficient up-down converter transformer which is 2 in 1 construction. (ex. SEPIC converter)
 It is possible to output the high voltage which is hard to obtain with an ordinary inductor with sufficient accuracy.
 It is available for a white LED back light drive.

CLS4D18

DIMENSIONS (mm)

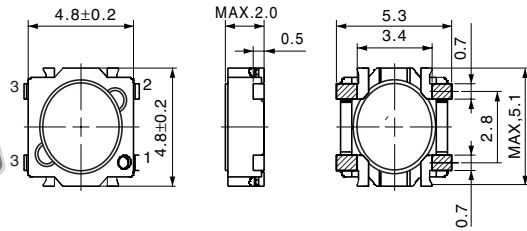

LAND PATTERNS (mm)

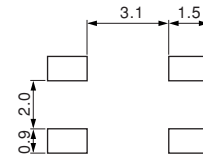

CLS4D28

DIMENSIONS (mm)

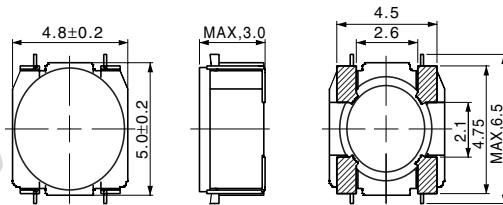

LAND PATTERNS (mm)

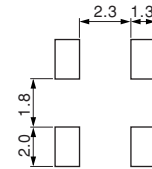

CLS6D28

DIMENSIONS (mm)

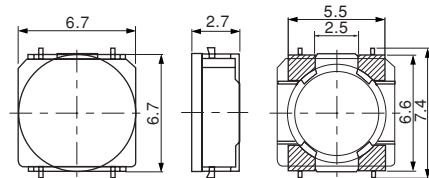

LAND PATTERNS (mm)

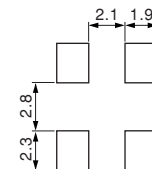

SEPIC CONVERTER SCHEMATIC

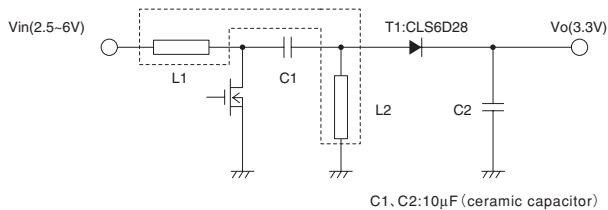

SEPIC CONVERTER CHARACTERISTIC

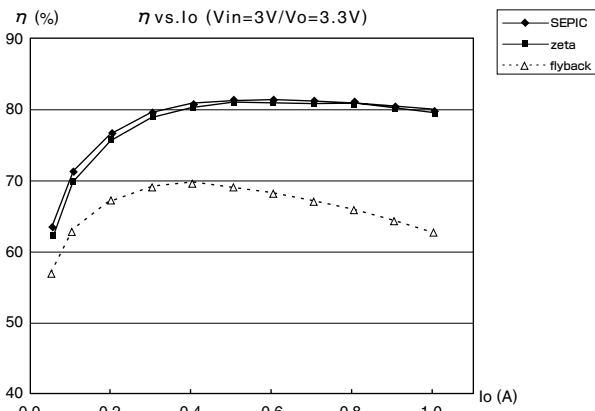
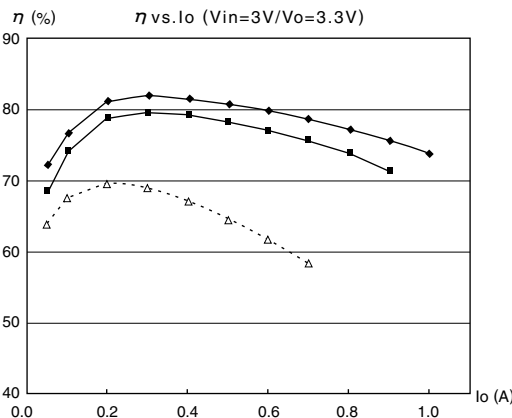

About CLS4D18, CLS4D28

※This specification might be changed without notice due to improving. Thank you for your understanding.

DC/DC Converter Transformers

OUTLINE

This is the transformer of multiple output type, which has size lineup.

There are Max.3.0mm high×5mm square and Max.2.5mm high×7mm square.

It is designed as a special structure to prevent wire breaking and solves the space reduction problem in the DSCs and DVCs.

CLQ5D27

DIMENSIONS (mm)

NEW



PROVISIONAL

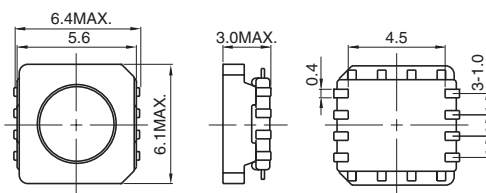

LAND PATTERNS (mm)

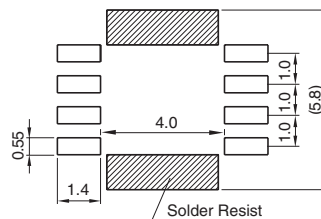

※In order to prevent short-circuiting, a solder resist is recommended.

SPECIFICATIONS

Max. Operating frequency	1MHz
Max. Operating power	350mW @ 300kHz
	580mW @ 500kHz
	1.1W @ 1MHz

CLQ7D23

DIMENSIONS (mm)

NEW

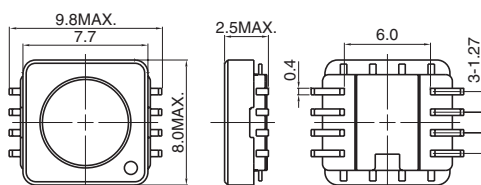

LAND PATTERNS (mm)

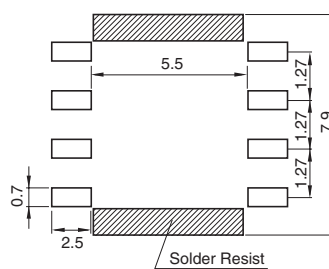

※In order to prevent short-circuiting, a solder resist is recommended.











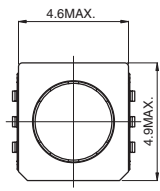
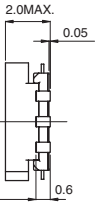
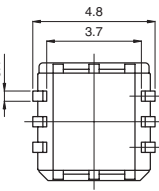

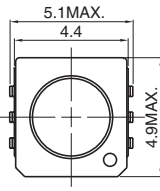
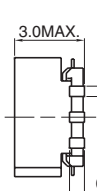
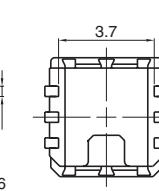

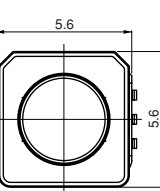
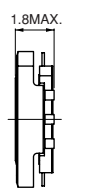
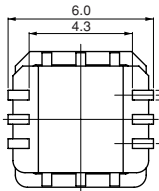

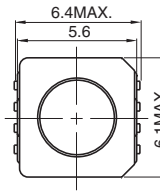
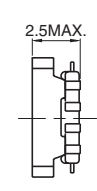
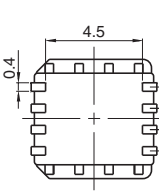
SPECIFICATIONS

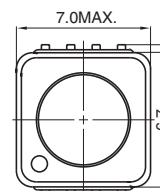
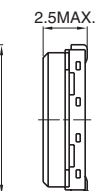
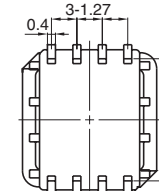
Max. Operating frequency	1MHz
Max. Operating power	450mW @ 300kHz
	700mW @ 500kHz
	1.4W @ 1MHz

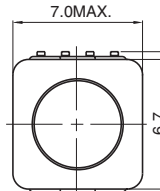
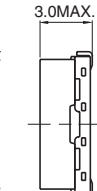
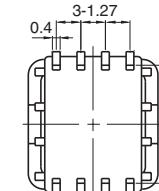

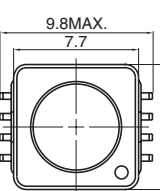
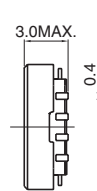
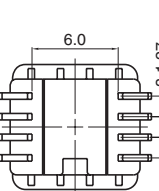

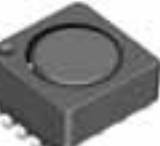
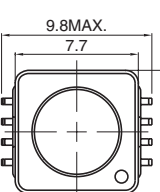
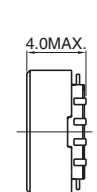
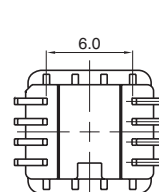





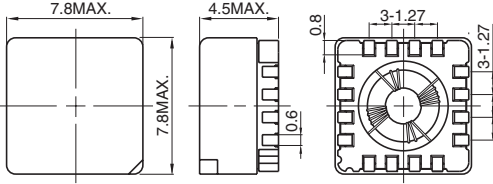

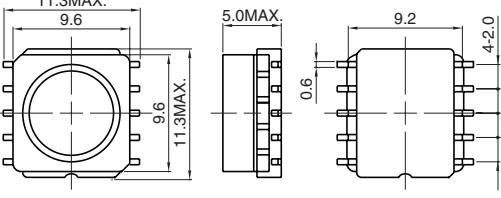

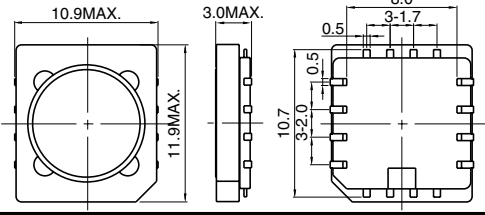

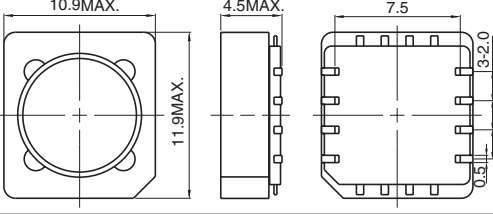
About CLQ5D27

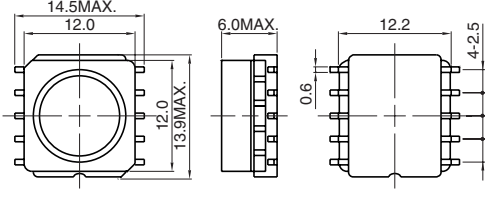
※This specification might be changed without notice due to improving. Thank you for your understanding.

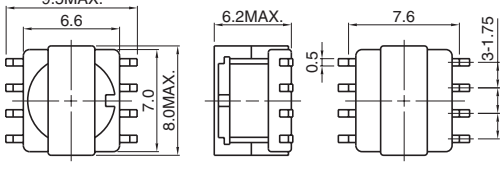

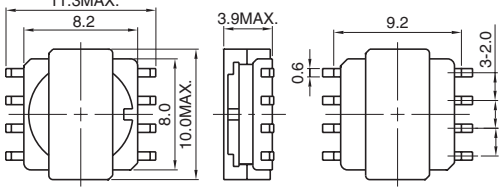

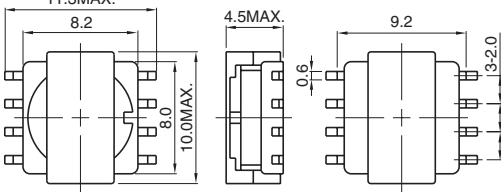





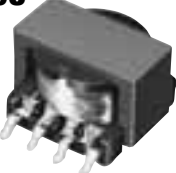
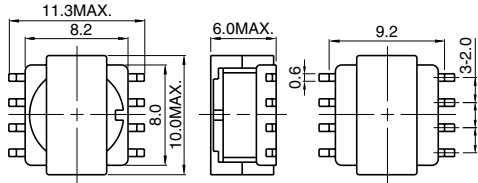

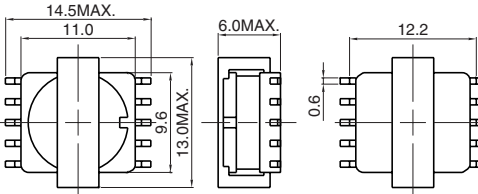

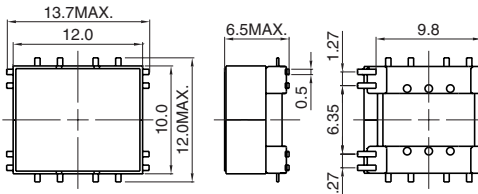

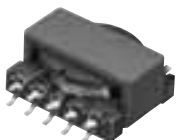
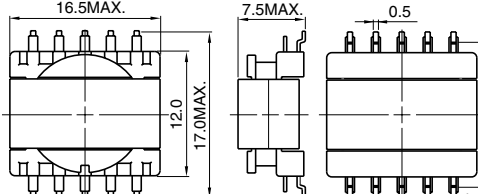
DC/DC COVERTER TRANSFORMERS

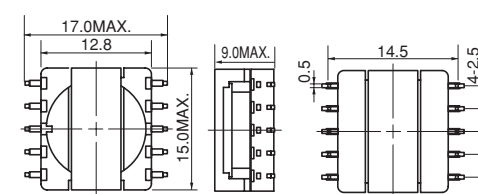
TYPE	DIMENSIONS(mm)			CONSTRUCTION	SPECIFICATIONS
CLQ4D18 					Inductance : Max.500 μ H Operating Freq. : Max. 1MHz Max. Operating Power : 100mW (300kHz) 175mW (500kHz) 350mW (1MHz)
CLQ4D27 					Inductance : Max.500 μ H Operating Freq. : Max. 1MHz Max. Operating Power : 160mW (300kHz) 270mW (500kHz) 540mW (1MHz)
CLQ5D16 					Inductance : Max.500 μ H Operating Freq. : Max. 1MHz Max. Operating Power : 290mW (300kHz) 480mW (500kHz) 930mW (1MHz)
CLQ52 					Inductance : Max.800 μ H Operating Freq. : Max. 1MHz Max. Operating Power : 290mW (300kHz) 480mW (500kHz) 930mW (1MHz)
CLQ72B 					Inductance : Max. 2.0mH Operating Freq. : Max. 1MHz Max. Operating Power : 220mW (300kHz) 380mW (500kHz) 780mW (1MHz)
CLQ72 					Inductance : Max. 3.0mH Operating Freq. : Max. 1MHz Max. Operating Power : 240mW (300kHz) 400mW (500kHz) 800mW (1MHz)
CLQ7D27 					Inductance : Max. 4mH Operating Freq. : Max. 1MHz Max. Operating Power : 640mW (300kHz) 1.0W (500kHz) 2.0W (1MHz)
CLQ7D37 					Inductance : Max. 5.2mH Operating Freq. : Max. 1MHz Max. Operating Power : 1.0W (300kHz) 1.8W (500kHz) 3.0W (1MHz)

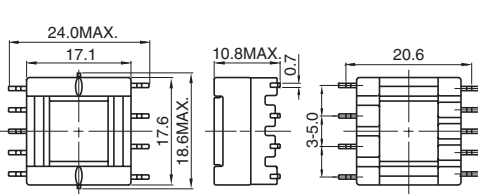
DC/DC COVERTER TRANSFORMERS

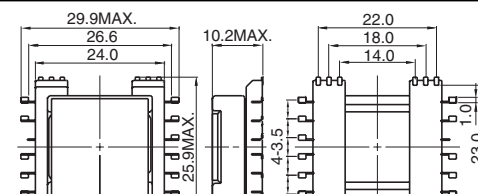

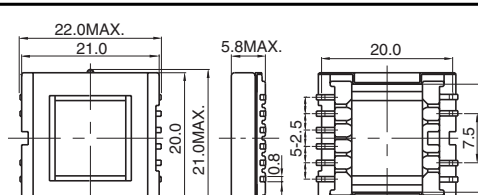







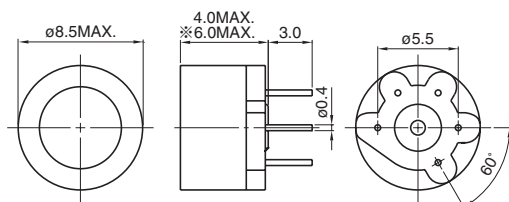

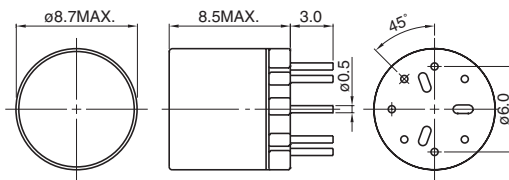

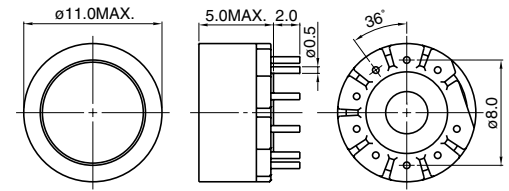

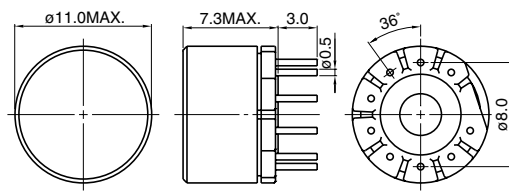
TYPE	DIMENSIONS(mm)	CONSTRUCTION	SPECIFICATIONS
CBM74	 		Inductance : Max. 1mH Operating Freq. : Max. 1MHz Max. operating power : 700mW(500kHz)
CLS-10	 		Inductance : Max. 4.3mH Operating Freq. : Max. 500kHz Max. Operating Power : 650mW (100kHz) 1.5W (300kHz) 2.2W (500kHz)
CLQ102	 		Inductance : Max. 8.2mH Operating Freq. : Max. 500kHz Max. Operating Power : 600mW (100kHz) 1.4W (300kHz) 2.2W (500kHz)
CLQ104	 		Inductance : Max. 18.0mH Operating Freq. : Max. 500kHz Max. Operating Power : 800mW (100kHz) 2.0W (300kHz) 3.0W (500kHz)
CLS-12	 		Inductance : 22mH Operating Freq. : Max. 500kHz Max. Operating Power : 1.2W (100kHz) 2.9W (300kHz) 4.3W (500kHz)
CEE-78	 		Inductance : Max. 300mH Operating Freq. : Max. 500kHz Max. Operating Power : 700mW (100kHz) 1.6W (300kHz) 2.4W (500kHz)
CEE93	 		Inductance : Max. 40mH Operating Freq. : Max. 500kHz Max. Operating Power : 400mW (100kHz) 900mW (300kHz) 1.8W (500kHz)
CEE94	 		Inductance : Max. 300mH Operating Freq. : Max. 500kHz Max. Operating Power : 870mW (100kHz) 2.0W (300kHz) 3.0W (500kHz)

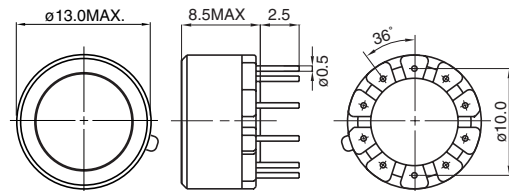
DC/DC COVERTER TRANSFORMERS

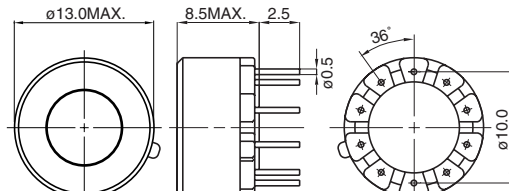

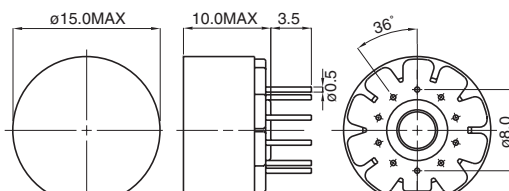

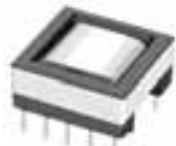
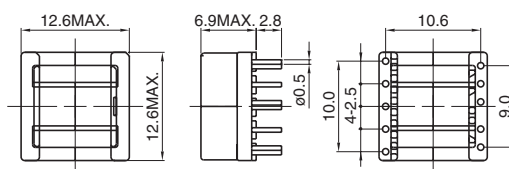





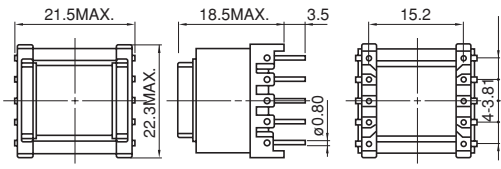

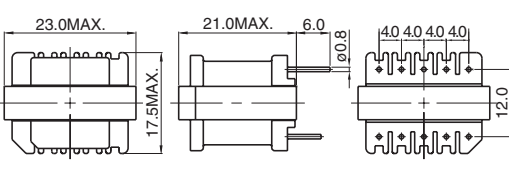

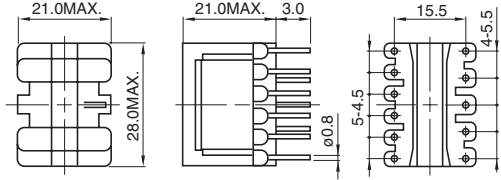

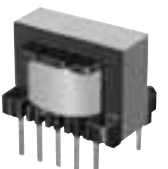
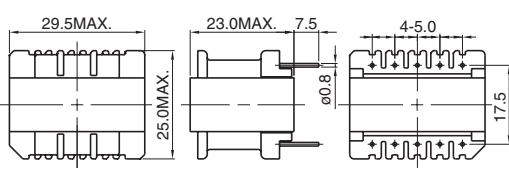

TYPE	DIMENSIONS(mm)	CONSTRUCTION	SPECIFICATIONS
CEE-98 			Inductance : Max. 1.1H Operating Freq. : Max. 500kHz Max. Operating Power : 1.1W (100kHz) 2.8W (300kHz) 4.2W (500kHz)
CEI-120 			Inductance : Max.2.0H Operating Freq. : Max. 500kHz Max. Operating Power : 1.2W (100kHz) 3.8W (300kHz) 6.3W (500kHz)
CEEH126 			Inductance : Max. 5.2mH Operating Freq. : Max. 500kHz Max. Operating Power : 1.0W (100kHz) 2.3W (300kHz) 3.4W (500kHz)
CEE156 			Inductance : Max. 125mH Operating Freq. : Max. 500kHz Max. Operating Power : 2.5W (100kHz) 6.0W (300kHz) 8.8W (500kHz)
CEE158 			Operating Freq. : Max. 500kHz Max. Operating Power : 2.6W (100kHz) 6.2W (300kHz) 9.3W (500kHz)
CEPH1710 			Inductance : Max. 700mH Operating Freq. : Max. 500kHz Max. Operating Power : 4.0W (100kHz) 10.0W (300kHz) 14.0W (500kHz)
CEPH199 			Inductance : Max. 130mH Operating Freq. : Max. 500kHz Max. Operating Power : 3.2W (100kHz) 7.5W (300kHz) 11.0W (500kHz)
CEPH205 			Inductance : Max. 3.0H Operating Freq. : Max. 500kHz Max. Operating Power : 800mW (100kHz) 2.5W (300kHz) 4.2W (500kHz)

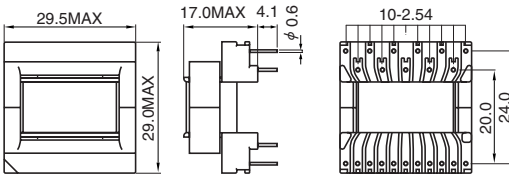
DC/DC CONVERTER TRANSFORMERS

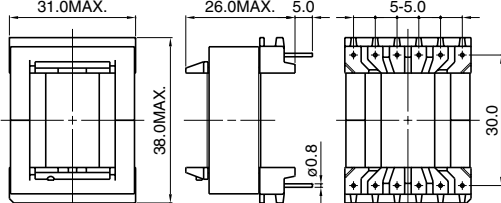

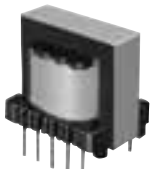
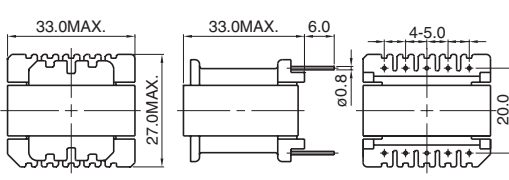
DC/DC CONVERTER TRANSFORMERS

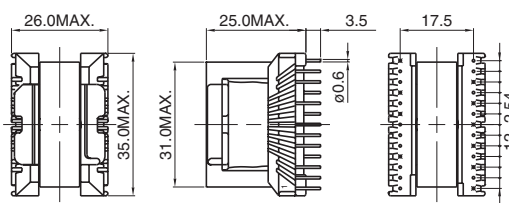
TYPE	DIMENSIONS(mm)	CONSTRUCTION	SPECIFICATIONS
LC-8/※LC-8U 			LC-8, LC-8U Operating Freq. : Max. 500kHz LC-8 Max. Operating Power : 320mW (100kHz) 750mW (300kHz) LC-8U Max. Operating Power : 370mW (100kHz) 1.1W (300kHz) 1.8W (500kHz)
MC-080U 			Operating Freq. : Max. 500kHz Max. Operating Power : 330mW (100kHz) 1.0W (300kHz) 1.7W (500kHz)
LC-10 			Operating Freq. : Max. 500kHz Max. Operating Power : 360mW (100kHz) 1.1W (300kHz) 1.8W (500kHz)
MC-100C 			Operating Freq. : Max. 500kHz Max. Operating Power : 960mW (100kHz) 2.2W (300kHz) 3.4W (500kHz)
LC-128 			Operating Freq. : Max. 500kHz Max. Operating Power : 1.5W (100kHz) 3.6W (300kHz) 5.0W (500kHz)
LC128B 			Operating Freq. : Max. 500kHz Max. Operating Power : 0.8W (100kHz) 1.9W (300kHz) 2.9W (500kHz)
LC-15 			Operating Freq. : Max. 300kHz Max. Operating Power : 2.7W (100kHz) 6.5W (300kHz)
EEH116 			Inductance : Max. 5.4mH Operating freq. : Max. 500kHz Max. Operating Power : 2.5W (100kHz) 5.8W (300kHz) 8.6W (500kHz)

DC/DC CONVERTER TRANSFORMERS

TYPE	DIMENSIONS(mm)	CONSTRUCTION	SPECIFICATIONS
EF2017 			Operating Freq. : Max. 500kHz Max. Operating Power : 3.3W (100kHz) 10.0W (300kHz) 16.5W (500kHz)
EI-22 			Operating Freq. : Max. 300kHz Max. Operating Power : 7.8W (100kHz) 18.0W (300kHz)
EI-255B 			Operating Freq. : Max. 300kHz Max. Operating Power : 16.0W (100kHz) 38.0W (300kHz)
EI-28 			Operating Freq. : Max. 300kHz Max. Operating Power : 22.0W (100kHz) 51.0W (300kHz)
EPH2815  			Operating Freq. : Max. 300kHz Max. Operating Power : 14.0W (100kHz) 32.0W (300kHz)
ERH2826 			Operating Freq. : Max. 500kHz Max. Operating Power : 11.0W (100kHz) 27.0W (300kHz) 40.0W (500kHz)
EI-30 			Operating Freq. : Max. 300kHz Max. Operating Power : 29.0W (100kHz) 67.0W (300kHz)
ER3023 			Operating Freq. : Max. 500kHz Max. operating power : 20W(500kHz) Weight : 30g

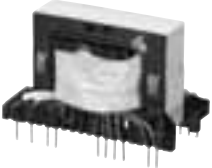
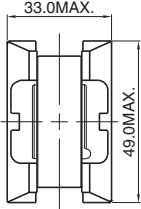
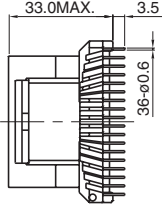
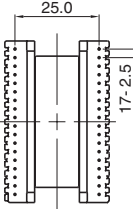
DC/DC CONVERTER TRANSFORMERS

TYPE	DIMENSIONS(mm)			CONSTRUCTION	SPECIFICATIONS
ER4831 					Inductance : Max. 56mH Operating Freq. : Max. 500kHz Max. operating power : 60W(500kHz) Weight : 75g

DC/DC CONVERTER TRANSFORMERS

Common Mode Choke Coils for DC LINES

SIGNAL COMMON MODE CHOKE COILS

■ OUTLINE

DC line noise filter for LCDTV, PC and Electronic Equipments.

CPFC805



● DIMENSIONS (mm)

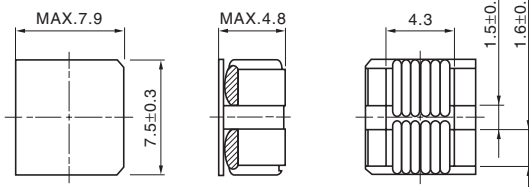

● LAND PATTERNS (mm)

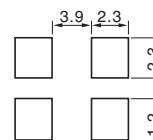

● SPECIFICATIONS

Impedance at 100MHz	D.C.R (1-4) (2-3)	Rated current
500Ω or more	7.5mΩ or less	4.5A

● IMPEDANCE CHARACTERISTICS

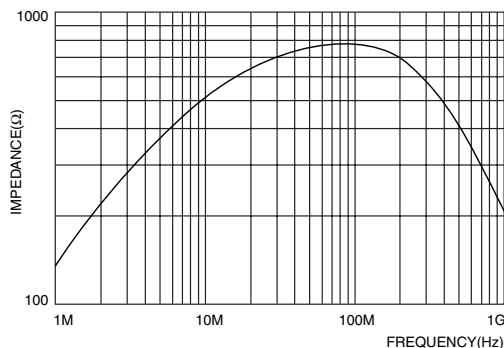

CPF6D36



● DIMENSIONS (mm)

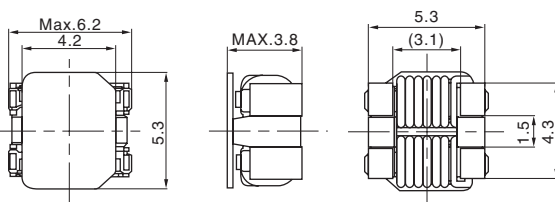

● LAND PATTERNS (mm)

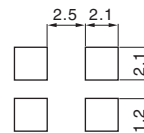

● SPECIFICATIONS

Impedance at 100MHz	D.C.R (1-4) (2-3)	Rated current
600Ω or more	22mΩ or less	2.5A

● IMPEDANCE CHARACTERISTICS

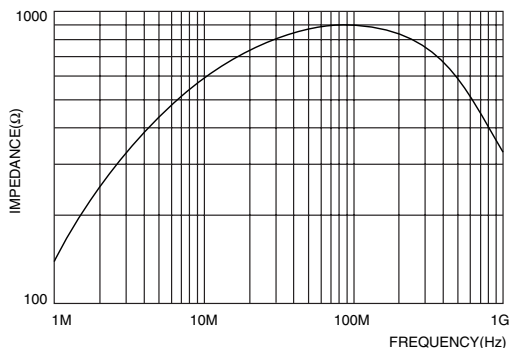

About CPF6D36

※This specification might be changed without notice due to improving. Thank you for your understanding.

Common Mode Choke Coil for Communication

OUTLINE

It is common mode noise filter of small and SMD type
It has 4-line construction and is suitable to IEEE1394.

CBM6068

DIMENSIONS(mm)



PROVISIONAL

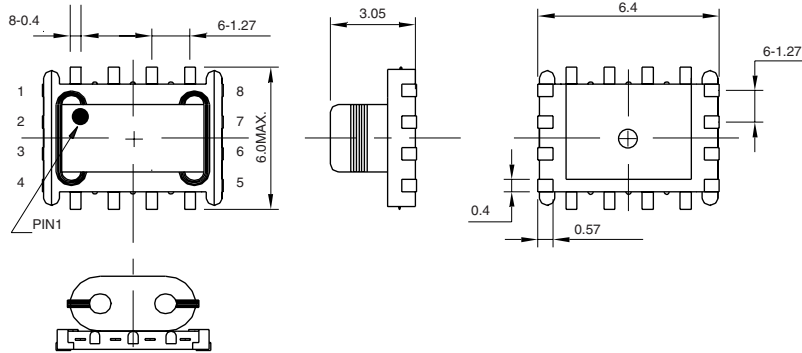

MEASUREMENT CIRCUIT DIAGRAM

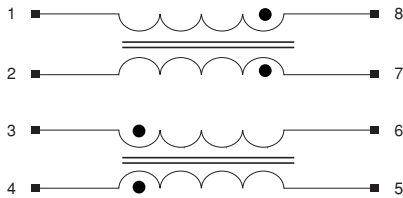

LAND PATTERNS(mm)

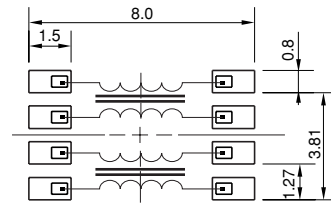

SUGGEST PCB LAYOUT TOLERANCE:







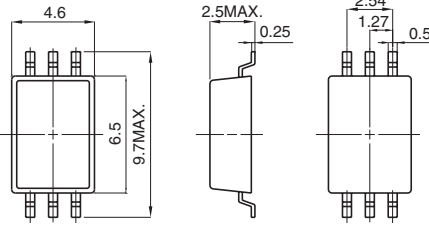

SPECIFICATIONS

ITEM	SPECIFICATION	CONDITION
D.C.R (1-8), (2-7), (3-6), (4-5)	0.3Ω MAX	20°C
I _{dc}	0.65 A MAX	
INSERTION LOSS	-2.8±2.0dB	50 MHz
	-7.3±2.5dB	100 MHz
	-12.0±3.0dB	300 MHz
	-14.0±3.0dB	500 MHz
HIPOT (1-8) TO (2,3,4, CORE),(2-7) TO (3,4, CORE) (3-6) TO (4, CORE),(4-5) TO CORE	DC 100 V	0.5mA, 1 minute.
INSULATION RESISTANCE (1-8) TO (2,3,4, CORE),(2-7) TO (3,4, CORE), (3-6) TO (4, CORE),(4-5) TO CORE	100 MΩ MIN	100Vdc, 1 minute
COMMON MODE IMPEDANCE	185Ω Typical	100 MHz

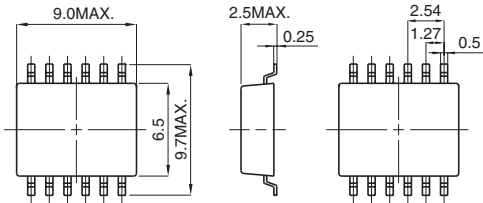

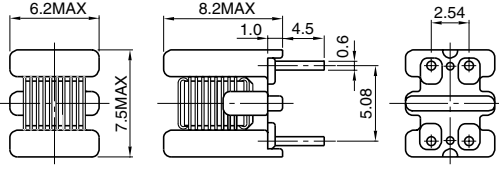

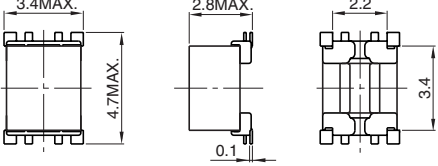

About CBM6068

※This specification might be changed without notice due to improving. Thank you for your understanding.

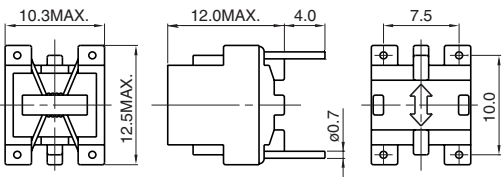

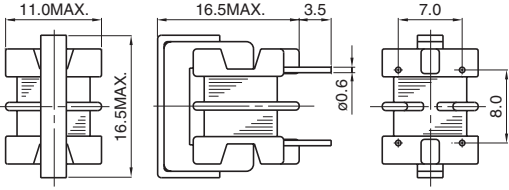

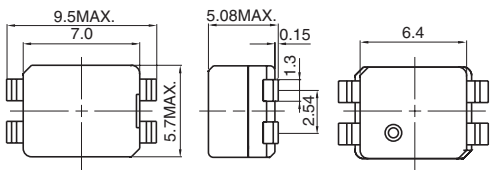





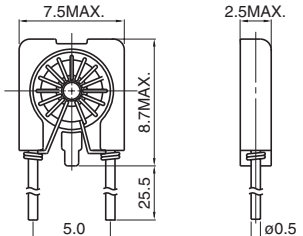

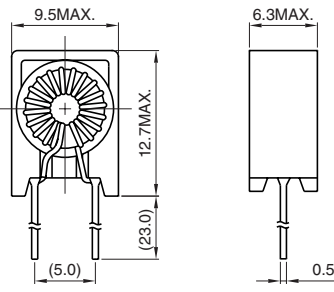
SIGNAL COMMON MODE CHOKE COILS

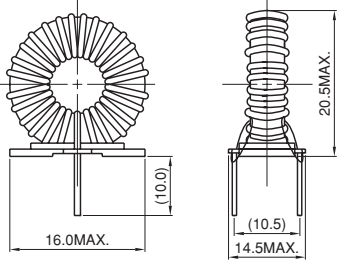
TYPE	DIMENSIONS(mm)	CONSTRUCTION	SPECIFICATIONS
CLP42 			Inductance : 50 μ H – 500 μ H Leakage Inductance : Max.0.3 μ H – Max.0.35 μ H Line capacitance : Max.6.0pF – Max.10.0pF D.C.R : Max.250m Ω – Max.300m Ω
CLP82 			Inductance : Max.500 μ H Leakage Inductance : Max.0.25 μ H Line capacitance : Max.10.0pF D.C.R : Max.700m Ω
SFC68 			Inductance : 4.3 μ H – 121.5 μ H D.C.R : 19.5m Ω – 114m Ω Rated Current : 600mA – 2.9A
CRR32 			Impedance : 350 Ω – 800 Ω (at 100MHz) D.C.R : 200m Ω – 500m Ω Rated Current : 400mA – 800mA

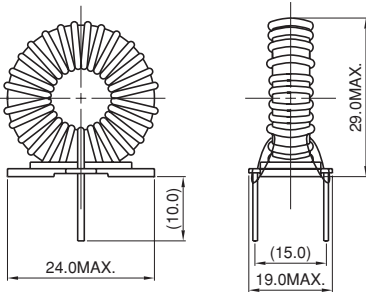
DC COMMON MODE CHOKE COILS

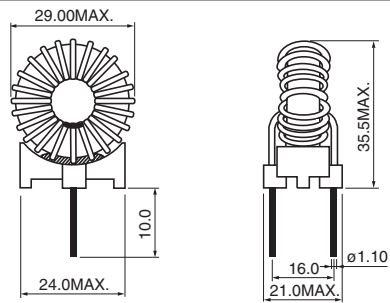

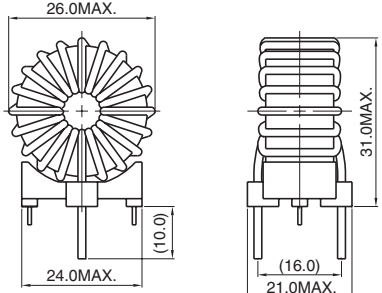







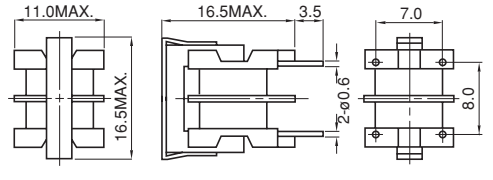

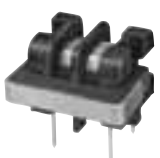
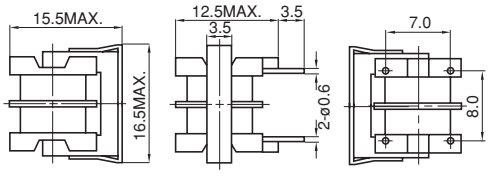

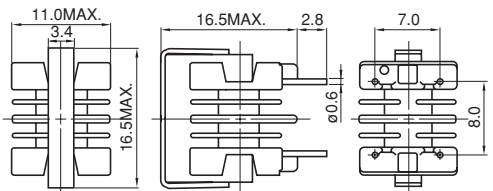

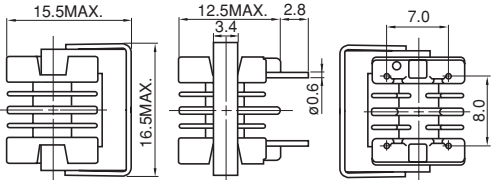
TYPE	DIMENSIONS(mm)	CONSTRUCTION	SPECIFICATIONS
BM1012LF 			Inductance : 0.20 μ H – 2.69 μ H Rated current : 2.2A – 3.4A
UU9TF 			Inductance : 8.6mH D.C.R : 3.0 Ω Rated current : 300mA
CPFC74 			Impedance : 100 Ω – 1k Ω (at100MHz) D.C.R : 60m Ω – 120m Ω Rated current : 1.5A – 3.0A

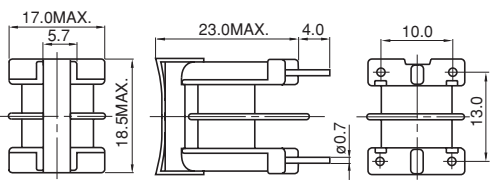
NORMAL MODE CHOKE COILS

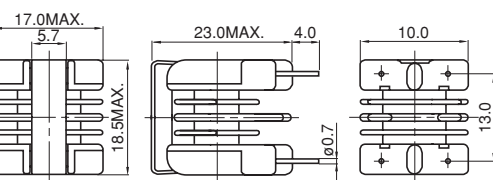
TYPE	DIMENSIONS(mm)	CONSTRUCTION	SPECIFICATIONS
BM27 			Impedance : 300Ω – 900Ω (10MHz) D.C.R : 150mΩ – 250mΩ
SLF0912 			Inductance : 18.0μH D.C.R : 44mΩ Rated current : 1.8A
PFN1316 			Inductance : 21μH – 37μH D.C.R : 43mΩ – 58mΩ Rated current : 2.0A – 5.4A
PFN1825 			Inductance : 32μH – 88μH D.C.R : 31mΩ – 53mΩ Rated current : 3.7A – 4.9A
PFN2029 			Inductance : 52μH – 83μH D.C.R : 30mΩ – 38mΩ Rated current : 5.4A – 6.1A
PFN2028 			Inductance : 52μH – 83μH D.C.R : 30mΩ – 38mΩ Rated current : 5.4A – 6.1A

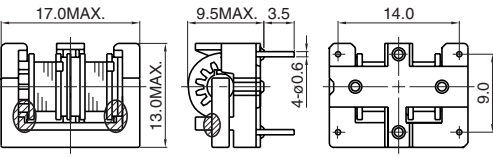

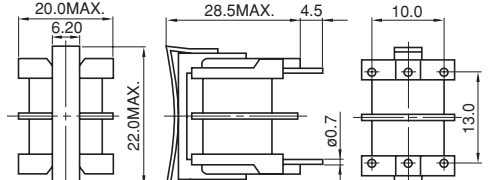







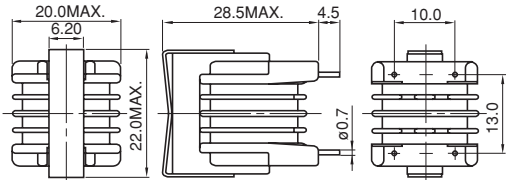

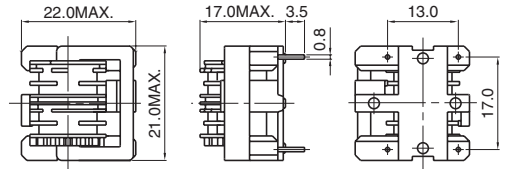

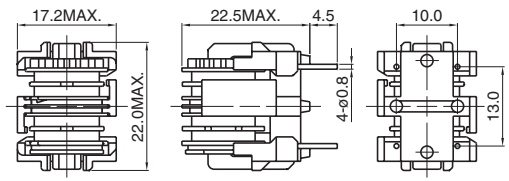
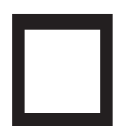
NORMAL MODE CHOKE COILS

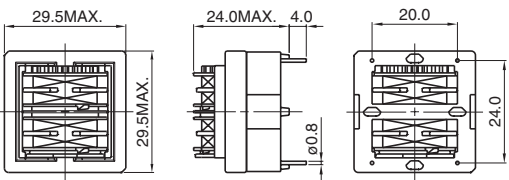
AC COMMON MODE CHOKE COILS

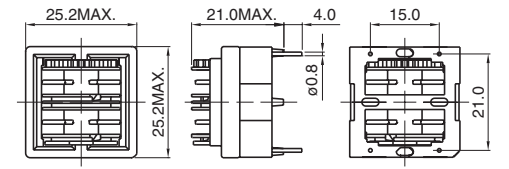
TYPE	DIMENSIONS(mm)	CONSTRUCTION	SPECIFICATIONS
UU9LF 			Inductance : 470 μ H – 10.0mH D.C.R. : 150m Ω – 4.0 Ω Rated current : 200mA – 1.0A
UU9LFH 			Inductance : 470 μ H – 10.0mH D.C.R. : 150m Ω – 40 Ω Rated current : 200mA – 1.0A
UU9LFB 			Inductance : Min. 19.0mH D.C.R. : 6.5 Ω Rated current : 150mA
UU9LFBH 			Inductance : Min.19.0mH D.C.R. : 6.5 Ω Rated current : 150mA
UU10LF 			Inductance : 3.3mH – 51.0mH D.C.R. : 710m Ω – 9.12 Ω Rated current : 150mA – 650mA
UU10LFB 			Inductance : 3.3mH – 51.0mH D.C.R. : 710m Ω – 9.12 Ω Rated current : 150mA – 650mA
LF1290 			Inductance : 470 μ H – 10.0mH D.C.R. : 150m Ω – 4.0 Ω Rated current : 200mA – 1.1A
UU16LF 			Inductance : 1.5mH – 30mH D.C.R. : 125m Ω – 2.5 Ω Rated current : 400mA – 1.9A

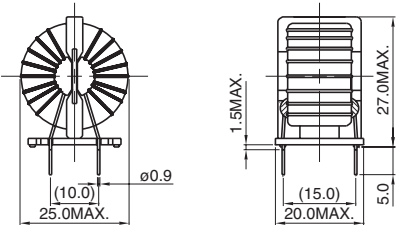
AC COMMON MODE CHOKE COILS

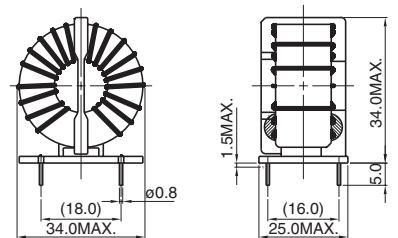
AC COMMON MODE CHOKE COILS

TYPE	DIMENSIONS(mm)	CONSTRUCTION	SPECIFICATIONS
UU16LFB 			Inductance : 1.5mH – 30mH D.C.R. : 200mΩ – 2.5Ω Rated current : 400mA – 1.9A
LF2115 			Inductance : 2.2mH – 33mH D.C.R. : 240mΩ – 3.42Ω Rated current : 300mA – 1.3A
LF2020 			Inductance : 2.2mH – 33mH D.C.R. : 240mΩ – 3.42Ω Rated current : 300mA – 1.3A
LF2823 			Inductance : 1.8mH – 68.0mH D.C.R. : 72mΩ – 1.82Ω Rated current : 600mA – 2.6A
LF2420 			Inductance : 2.5mH – 35mH D.C.R. : 130mΩ – 1.58Ω Rated current : 600mA – 2.0A
PFC2225B 			Inductance : 450μH – 7.0mH D.C.R. : 8.5mΩ – 135mΩ Rated AC current : 2.5A – 10.0A
PFC2831 			Inductance : 600μH – 1.5mH D.C.R. : 4.8mΩ – 18.5mΩ Rated current : 8.5A – 17A

Transponder • RF-ID (TX)

■ OUTLINE

Suitable for Key less enter and Home security system's Tx-ant

AS737

● DIMENSIONS(mm)

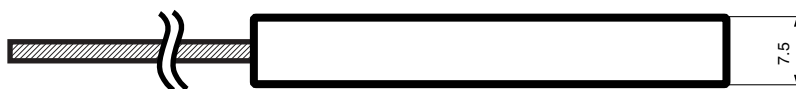
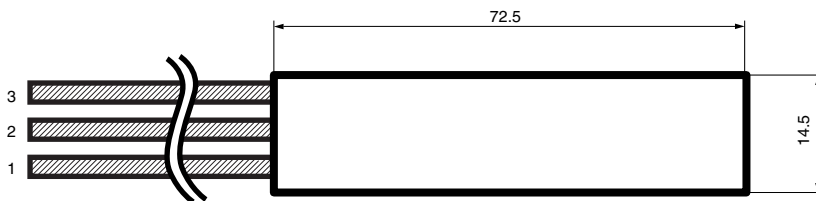
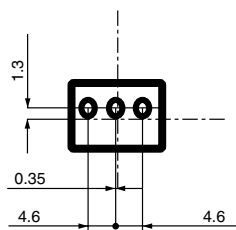

PROVISIONAL

● SCHEMATICS

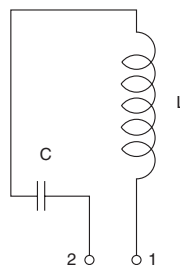
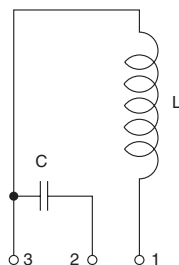

* It is possible 2 terminal type (①—②)

◆ FEATURES

1. Pre-tune Ant provide high efficiency in customer line
2. Molding improved from environmental suffering
3. 2 terminals out available
4. Packaging can be available (with Harness, Connector and Casing)

● SPECIFICATIONS(REFERENCE)

Tuning Frequency	125.0±1.0kHz within
Impedance	1.0Ω (typ.)

* It is possible for customer specification at harness length and connector form.

※This specification might be changed without notice due to under developing and improving. Thank you for your understanding.

Noise Filter

OUTLINE

It is AM Radio Noise reduction filter which is combined with an antenna of Smart Entry System.

CEP79

DIMENSIONS(mm)

SCHEMATICS

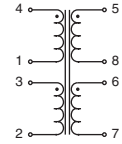
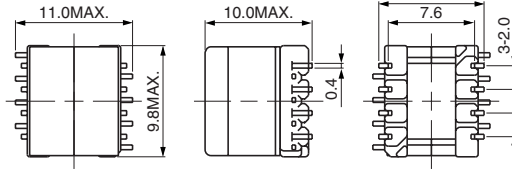

SPECIFICATIONS

Inductance (4-1)	260μH ±35%	(2-1, 4-3 tie)
D.C.R (4-1)	50mΩ below	(3-4, 2-1 tie)
D.C.R (8-5)	50mΩ below	(5-6, 8-7 tie)
Temperature Rise	2.5A@Δ=30°C (D.C.Current)	
Current (Typ.)	6.8A@Δ=30°C (Dummy Load Current)	

Characteristics

Common Attenuation

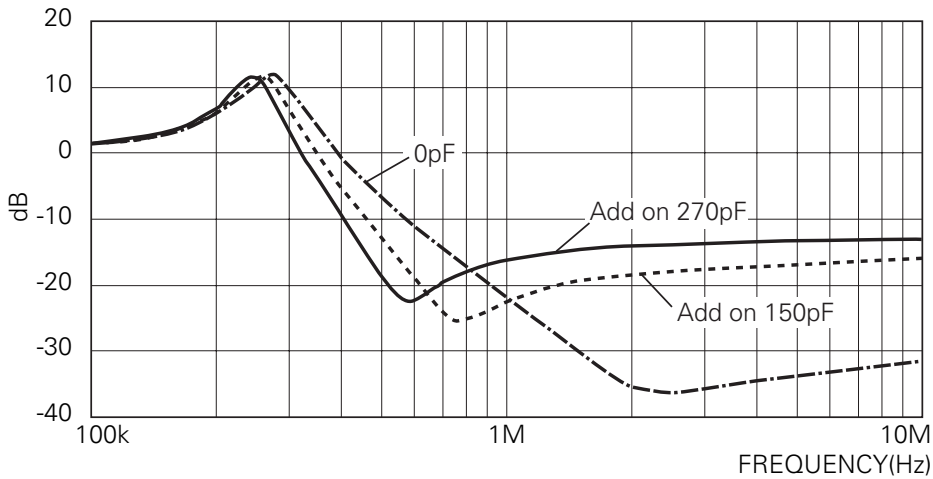

Transponder • RF-ID (RX)

OUTLINE

Antenna coils for Keyless Entry Systems, Smart Entry Systems and Passive Entry Systems RF-ID etc.

CAS11D21

NEW



DIMENSIONS (mm)

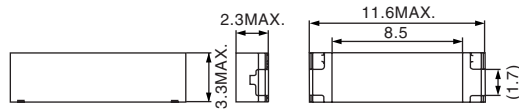

LAND PATTERNS (mm)

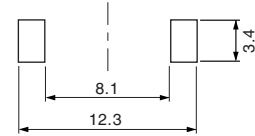

CAS11D28



DIMENSIONS (mm)

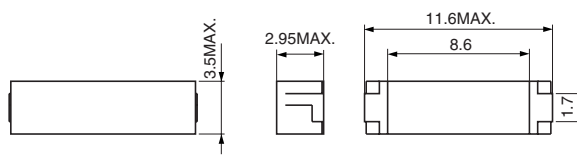

LAND PATTERNS (mm)

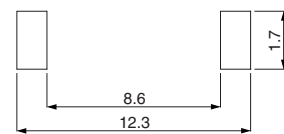

CAS14D26



DIMENSIONS (mm)

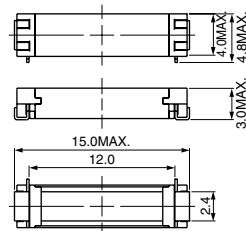

LAND PATTERNS (mm)

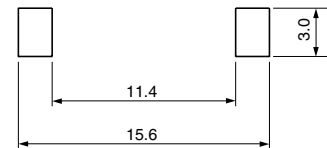

CAS16D14

NEW



DIMENSIONS (mm)

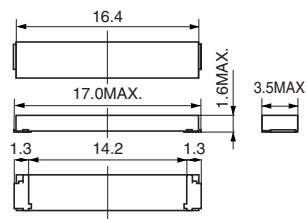

LAND PATTERNS (mm)

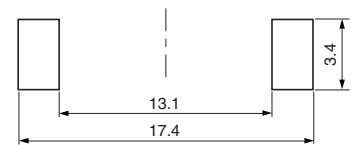

CAK15D14



DIMENSIONS (mm)

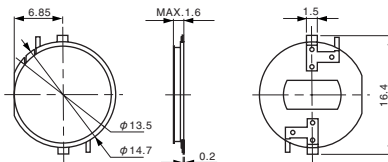

LAND PATTERNS (mm)

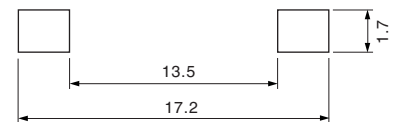

SPECIFICATIONS

Product Type	Inductance	Q	S.R.F.	Sensitivity	Frequency
CAS11D21	2.3mH	Min. 30	1MHz	Min. 29mV/A/m	125kHz
CAS11D28	500μH~7.2mH	Min. 30	700kHz	50mV/μT (7.2mH)	125kHz
CAS14D26	900μH~2.4mH	Min. 30	1MHz	38mV/μT (2.3mH)	125kHz
CAS16D14	1mH~6mH	35 (TYP.)	650kHz	68mV/μT (6mH)	125kHz
CAK15D14	1mH~6mH	13 (TYP.)	1MHz	55mV/μT	125kHz

OUTLINE

This is the RF-ID transponder coil, which is for related security equipment and keyless entry systems for automobiles.

AR9D27

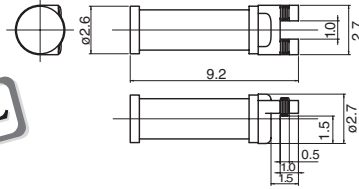
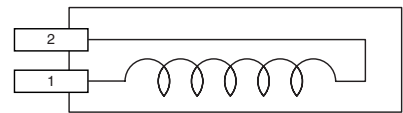
DIMENSIONS (mm)

SCHEMATICS

SPECIFICATIONS

Inductance	Q	S.R.F.	Sensitivity	Frequency
1.0mH~5.0mH	Min. 30	1000kHz	41mV/μT (5.0mH)	125kHz

※This specification might be changed without notice due to under developing and improving. Thank you for your understanding.

OUTLINE

It is transponder antenna coil which also performs as key-less entry antenna built into key case.

CAS19D17C

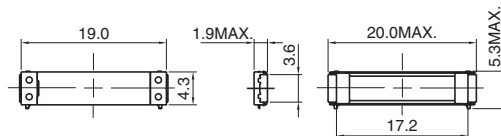
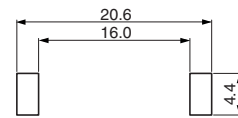
DIMENSIONS (mm)

LAND PATTERNS (mm)

SPECIFICATIONS (REFERENCE)

Inductance	Q	S.R.F.	Sensitivity	Frequency
1mH~7mH	Min. 40	Min. 400kHz	82mV/μT (7mH)	125kHz

TPMS • RF-ID

OUTLINE

It is TPMS(Tire Pressure Monitoring System)

CAS113

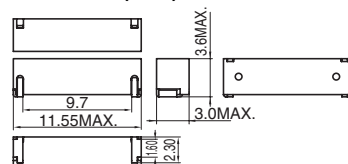
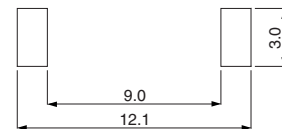
DIMENSIONS (mm)

LAND PATTERNS (mm)

SPECIFICATIONS (REFERENCE)

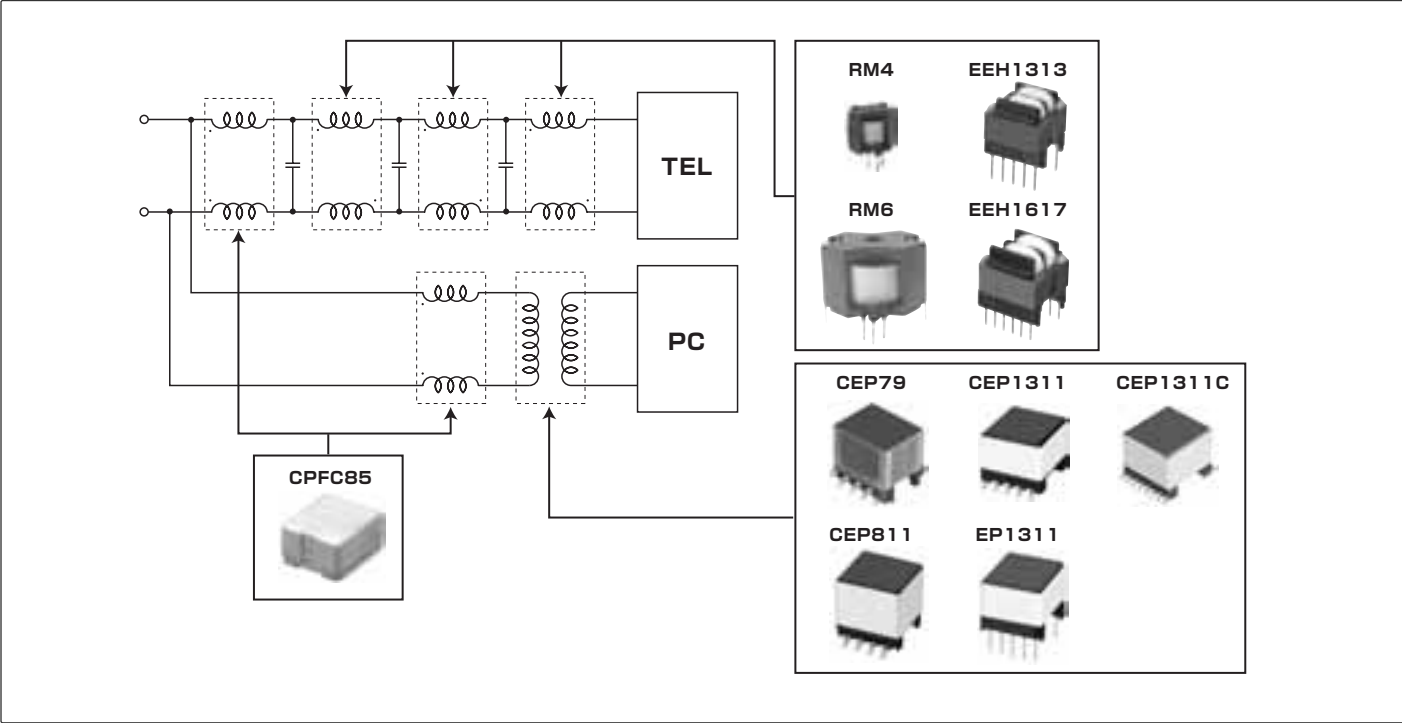
Inductance	Q	S.R.F.	Sensitivity	Frequency
7.2mH	55	700kHz	50mVp-p/μT	125kHz
2.89mH	45	700kHz	31mVp-p/μT	125kHz

For xDSL LINE TRANSFORMER & SPLITTER COILS



For xDSL LINE TRANSFORMER & SPLITTER COILS

Line Transformer

OUTLINE

It is a xDSL line transformer which corresponds to the smaller foot print demand for limited equipment installation space in central offices.

Application is the xDSL line transformer used in central offices.

CEP79



DIMENSIONS(mm)

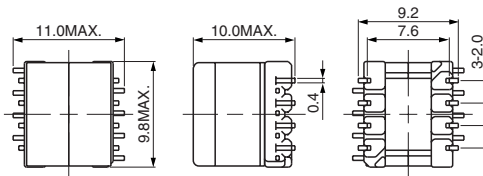

SCHEMATICS

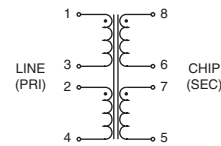

APPLICATION

Line transformer for control operation side.

SPECIFICATIONS

Impedance (1-4)	Designed to reflect 100Ω on the PRI with 100Ω load on SEC.	
Inductance (1-4)	850μH ±10%	(10kHz 0.1V) 2+3 tie
Turns Ratio	1 : 1 (±1%)	(PRI : SEC)
Leakage Inductance (1-5)	3.6μH (TYP)	(100kHz 0.1V) 2+3, 6+7 tie, 5+8 short
D.C.R (1-3)	1.2Ω(TYP)	(20°C)
D.C.R (2-4)	0.9Ω(TYP)	(20°C)
D.C.R (5-7)	0.85Ω(TYP)	(20°C)
D.C.R (6-8)	0.8Ω(TYP)	(20°C)
Insertion loss	0.1dB(TYP)	(30kHz-1.1MHz)
Total Harmonic Distortion	-75dB(TYP)	(40kHz, 5.3Vrms)
	-90dB(TYP)	(100kHz, 5.3Vrms)
Longitudinal Balance	70dB(TYP)	(100kHz) (6, 7 GND)
Isolation Voltage	1875Vrms 1SEC (50Hz/60Hz) between PRI-SEC	

Longitudinal Balance : This characteristic was measured with our longitudinal test circuit board.

xDSL LINE TRANSFORMER

NEW PRODUCTS

OUTLINE

Application is the xDSL line transformer.

CPE1311C

DIMENSIONS(mm)

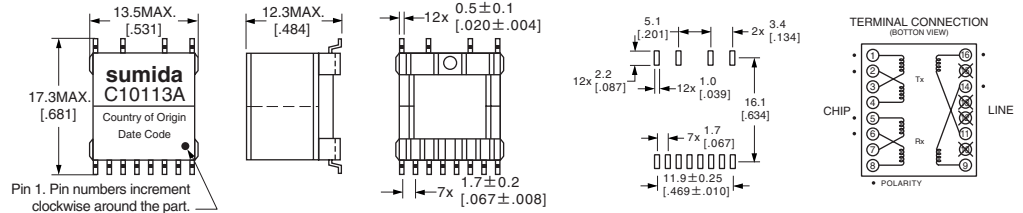

FEATURES

- Approved by GlobespanVirata for use with the following chipsets : Argon™ II / II Plus, Argon™ III / III Plus, Centragate™, Titanium™ Ultra/Ultra Plus, and Viking™ II
- Superb THD performance (-93 dB typ. from 20 kHz, Tx and Rx windings)
- Complies with EN 60950/UL60950/BABT/TÜV supplementary insulation requirements for working voltages up to 250 Vrms

ELECTICAL SPECIFICATIONS

Parameter	Conditions	Limit	Units	Tolerance
Inductance(OCL)	line side, 10kHz, 0.1V, (16-9) [tie 11+14]	700	μH	±6%
Turns Ratio(T/R)	chip - Tx:line=(1-4):(16-9) [tie 2+3, 11+14]	1:3.95	N/A	+1.5% -1.0%
	chip - Rx:line=(5-8):(16-9) [tie 6+7, 11+14]	1:2.04	N/A	±1.5%
Total Harmonic Distortion(THD)	Tx and Rx windings, 20kHz, 5.3Vrms	-87	dB	Max.
Leakage Inductance(LL)	100kHz, 0.1V, (16-9) [tie 1+4, 2+3, 11+14]	32	μH	Max.
	100kHz, 0.1V, (16-9) [tie 5+8, 6+7, 11+14]	32	μH	Max.
Longitudinal Balance(LB)	35kHz - 650kHz (16-9) [tie 11+14]	53	dB	Min.
DC Resistance(DCR)	line side, (16-9) [tie 11+14]	3.5	Ω	Max.
	chip side - Tx, (1-4) [tie 2+3]	0.98	Ω	Max.
	chip side - Rx, (5-8) [tie 6+7]	1.74	Ω	Max.
Interwinding Capacitance(Cww)	100kHz, 0.1V, (1-16) [tie 2+3, 11+14]	50	pF	Max.
	100kHz, 0.1V, (5-16) [tie 6+7, 11+14]	50	pF	Max.
Dielectric Breakdown Isolation (equivalent to 1 min, 1500 Vrms)	1 sec, (1-16) [tie 2+3, 4+5, 6+7, 11+14]	1875	Vrms	Min.
Impedance	reflected on line side	100	Ω	Non.
	load on chip side, Tx	5.6	Ω	Non.
	load on chip side, Rx	300	Ω	Non.
Operating Temperature		-40 to +85	°C	Non.

xDSL LINE TRANSFORMER

NEW PRODUCTS

For xDSL LINE TRANSFORMERS

OUTLINE

Application is the xDSL line transformer.

CEP1311



DIMENSIONS (mm)

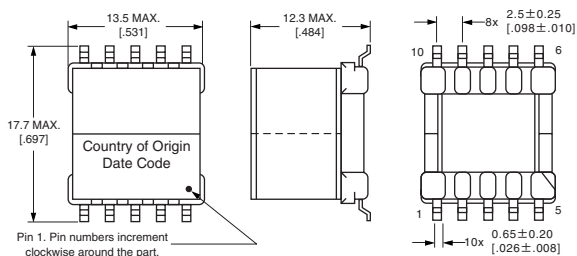

RECOMENED LAND PATTRNS

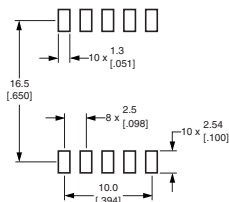

SCHEMATICS

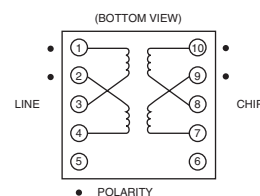

EP1311



DIMENSIONS (mm)

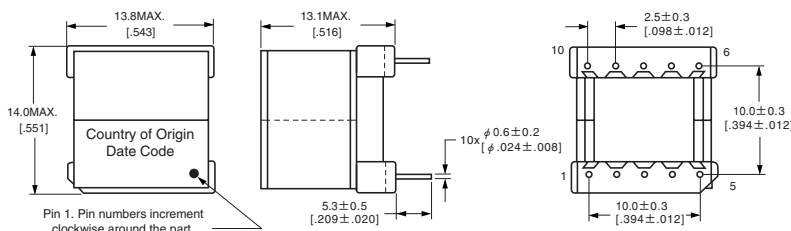

TERMINAL LAYOUT

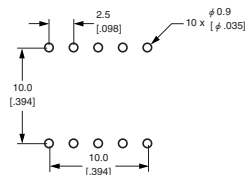

SCHEMATICS

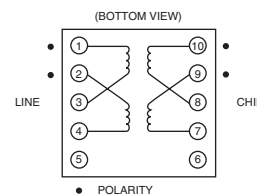

FEATURES

- Approved by TI for use with the following chipsets :
AR7, AR7V, AR7VWi.
C10120 & T10120 for Annex A.C.
C10121 & T10121 for Annex B.
- Superb LB from 30kHz to 1.1MHz
- Complies with EN 60950/BABT/TUV supplementary insulation requirements for working voltages up to 250 Vrms

ELECTRICAL SPECIFICATIONS

Sumida Type	Part No.	INDUCTANCE (Ls)1-4	TURNS RATIO	LL MAX (1-4)	THD MAX (dB)	LB MAX (dB)	DCR MAX (Ω)	IMPEDANCE
		10kHz, 0.1V, (2+3)Tie	(10-7):(1-4)	100kHz, 0.10Vac	100kHz, 5.3Vrms	30kHz-1.1MHz	(1-4)/(10-7)	(1-4)/(10-7)
CEP1311	C10120	1.5mH ±6% WITHIN	1:2(+2%)	14uH (2+3, 8+9)Tie	-90db	60db	1.82/0.76	100Ω/25Ω
CEP1311	C10121	400uH ±5% WITHIN	1:2(+2%)	7uH (2+3, 8+9)Tie	-90db	60db	0.63/0.33	100Ω/25Ω
EP1311	T10120	1.5mH ±6% WITHIN	1:2(+2%)	14uH (2+3, 8+9)Tie	-90db	60db	1.82/0.76	100Ω/25Ω
EP1311	T10121	400uH ±5% WITHIN	1:2(+2%)	7uH (2+3, 8+9)Tie	-90db	60db	0.63/0.33	100Ω/25Ω

xDSL POTS SPLITTER COILS

OUTLINE

It is pot splitter coil for xDSL. correspondence with each ITU-T (Annex-A/E/C) standard.
Using EE core for compatibility and competitive cost merit.

EEH1313

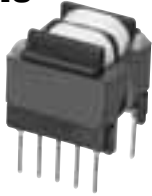

DIMENSIONS(mm)

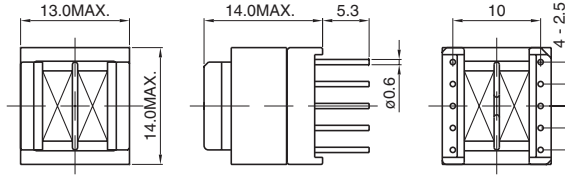

SCHEMATICS

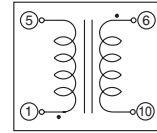

OUTLINE

Apot splitter coil for ADSL Splitter.

FEATURES

Correspondence with each ITU-T(Annex-A/E/C) standard.
Using EE core for compatibility and competitive cost merit.

APPLICATION

ADSL Splitter

SPECIFICATIONS

Part No.	Inductance	D.C.R
50M-020	2.4mH (Typ.) (at 1kHz, 0.1V)	2.7Ω(Typ.)
50M-021	0.983mH (Typ.) (at 1kHz, 0.1V)	1.0Ω(Typ.)
50M-022	0.712mH (Typ.) (at 1kHz, 0.1V)	0.9Ω(Typ.)

Weight

5g

EEH1617

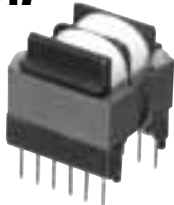

DIMENSIONS(mm)

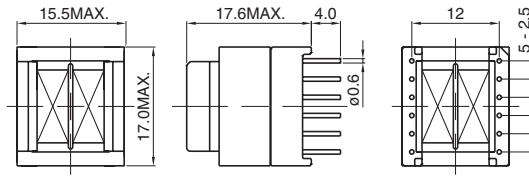

SCHEMATICS

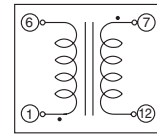

OUTLINE

Inductor available for ADSL Splitter.

FEATURES

Correspondence with each ITU-T(Annex-A/E/C) standard.
Using EE core for compatibility and competitive cost merit.

APPLICATION

ADSL Splitters

SPECIFICATIONS

Part No.	Inductance	D.C.R
50M-026	10.5mH(Typ.) (at 1kHz,0.1V)	5.8Ω(Typ.)
50M-027	4.5mH(Typ.) (at 1kHz,0.1V)	2.3Ω(Typ.)
50M-028	4.0mH(Typ.) (at 1kHz,0.1V)	2.2Ω(Typ.)

Weight

10g

Application Circuit

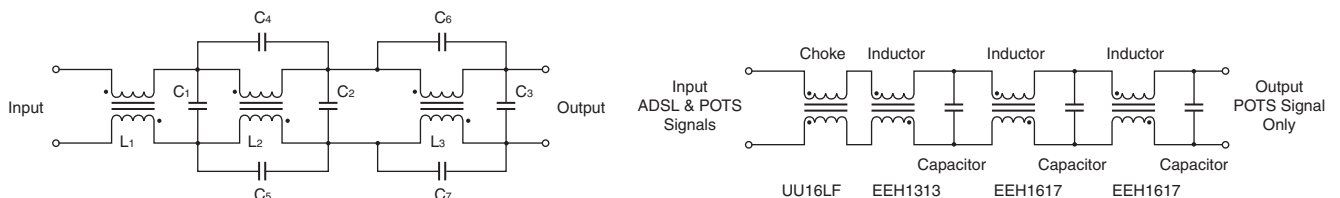

xDSL POTS SPLITTER COILS

CEEH1011

● DIMENSIONS (mm)

● RECOMENED LAND PATTRNS

● SCHEMATICS

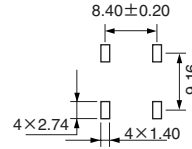
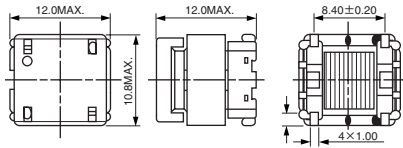

◆ FEATURES

- Small footprint for Central Office applications
- For use with Legerity's Intergrated Voice and Data (IVD) solution
- Customized inductance values available

● SPECIFICATIONS

Part No.	Inductance MIN (mH)				LL MAX 100kHz, 0.10 Vac	THD MAX (dB) 50kHz, 12.3Vrms	LB MAX (dB) 200Hz-3200Hz	DCR MAX (Ω) PRI/SEC
	20kHz 0.1 Vac, 0 Adc	20kHz 0.1 Vac, 0.12 Adc	20kHz 0.1 Vac, 0.23 Adc	20kHz 0.1 Vac, 0.46 Adc				
C15100	8.74	8.46	4.00		25μH	-85db	65db	26.0/26.0
C15108	3.42	3.40		1.00	11μH	-85db	65db	18.5/18.5

RM4

● DIMENSIONS (mm)

● SCHEMATICS

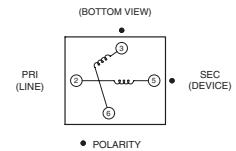
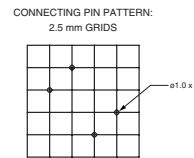

◆ FEATURES

- Small footprint for Central Office applications
- For use with Legerity's Intergrated Voice and Data (IVD) solution
- Customized inductance values available

● SPECIFICATIONS

Part No.	Inductance MIN (mH)			LL MAX 100kHz, 0.10 Vac	THD MAX (dB) 50kHz, 12.3Vrms	LB MAX (dB) 200Hz-3200Hz	DCR MAX (Ω) PRI/SEC
	20kHz 0.1 Vac, 0 Adc	20kHz 0.1 Vac, 0.12 Adc	20kHz 0.1 Vac, 0.23 Adc				
T15107	8.74	8.46	4.00	8μH	-85db	65db	26/26

T= Through Hole

RM6

● DIMENSIONS (mm)

● SCHEMATICS

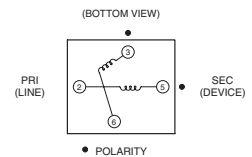
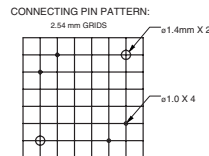
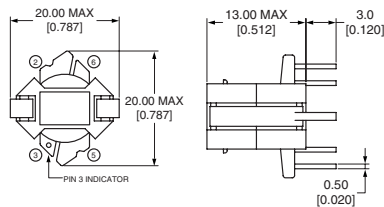

◆ FEATURES

- Excellent Longitudinal Balance
- For use with Legerity's Intergrated Voice and Data (IVD) solution
- Customized inductance values available

● SPECIFICATIONS

Part No.	Inductance MIN (mH)			LL MAX 100kHz, 0.10 Vac	THD MAX (dB) 50kHz, 12.3Vrms	LB MAX (dB) 200Hz-3200Hz	DCR MAX (Ω) PRI/SEC
	20kHz 0.1 Vac, 0 Adc	20kHz 0.1 Vac, 0.12 Adc	20kHz 0.1 Vac, 0.23 Adc				
T15101	6.44	6.30	4.00	8μH	-85db	65db	11/11
T15102	8.74	8.46	4.00	8μH	-85db	65db	13.6/13.6

T= Through Hole

xDSL COMMON MODE CHOKE COIL

OUTLINE

SMD Common Mode Choke avail for xDSL modem.
This is small size, SMD and having that impedance is 15kΩ at 1.0MHz.

CPFC85

DIMENSIONS(mm)

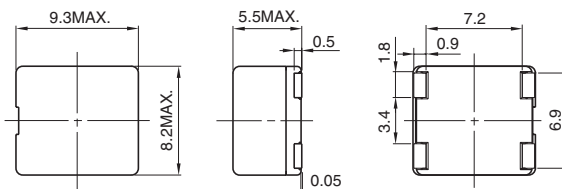

SCHEMATICS

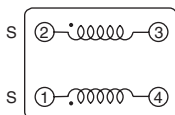

IMPEDANCE/COMMON MODE ATTENUATION CHAR.

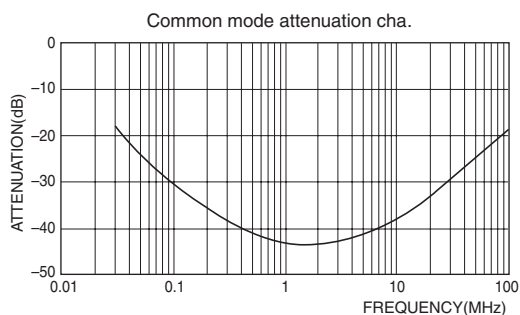
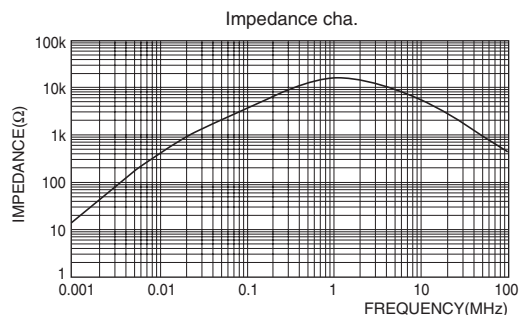

ELECTRICAL SPECIFICATIONS

INDUCTANCE	Min. 3.3mH	100kHz
D. C. R (1-4) (2-3)	Max. 0.6Ω	
IMPEDANCE (1-4) (2-3)	Min. 2.3Ω	100kHz
IMPEDANCE (1-4) (2-3)	Min. 9.8Ω	1MHz
IMPEDANCE (1-4) (2-3)	Min. 4.2Ω	10MHz
COMMON MODE ATTENUATION	30 dB(typ.)	100kHz
COMMON MODE ATTENUATION	43 dB(typ.)	1MHz
COMMON MODE ATTENUATION	38 dB(typ.)	10MHz
WITHSTAND VOLTAGE (line-line)	Min. 700Vrms (2 sec.)	50Hz/60Hz

◆FEATURES

1. EMI Filter of 15kΩ Impedance at 1.0MHz.
2. Small size.
3. Reflow soldering is possible as SMD type.

◆APPLICATION

1. ADSL Modem
2. Telecom applications

STB/FAX/MODEM TRANSFORMERS

OUTLINE

This is a Fax modem transformer of V.32(9.6kbps) to V.92 (56kbps) conformity.
It is a UL/BABT authorization article.

MT1610/MT1610B

DIMENSIONS (mm)

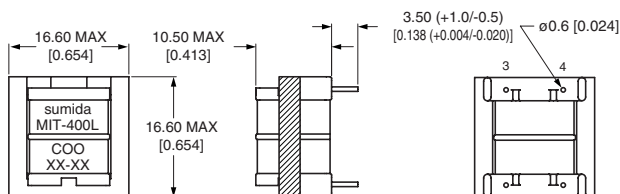
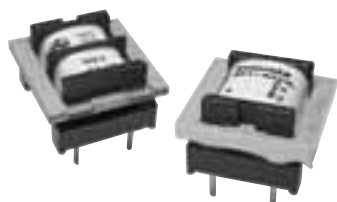

SCHEMATICS

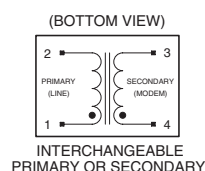

FEATURES

- Internationally Safety Approved for Supplementary Isolation
- EN 60950/BABT/TUV
- Low cost
- V.92 (56kbps) to V.32 bis (14.4kbps) THT fax/modem transformer
- Reinforced safety encapsulated versions also available

SPECIFICATIONS

Part No.	Speed	Impedance(Ω) PRI:SEC	THD@600Hz (dB)	IL (dB)	RL (dB)	LL (mH)	DCR (Ω) PRI:SEC
MIT4033L	V.92	600:420	-85	1.90	20	3.7	82/106
MIT2050L	V.92	600:560	-87	1.55	17	17	70/70
MIT250L	V.34	600:560	-84	1.55	17	17	70/70
MIT400L	V.32bis	600:600	-62	1.80	14	15	70/70

- MIT4033L Approved By TDK use for 79M1903chip.

MT2212

DIMENSIONS (mm)

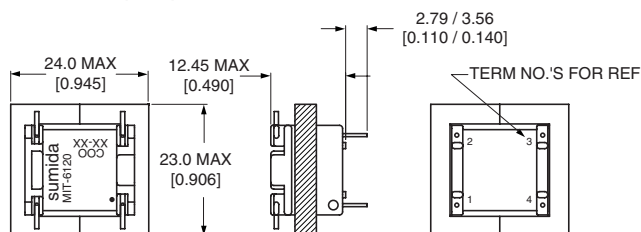
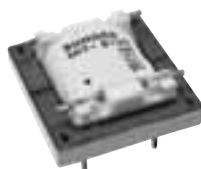

SCHEMATICS

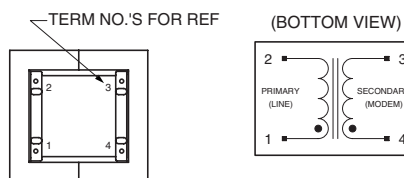

FEATURES

- Internationally Safety Approved for Supplementary Isolation
- EN 60950/BABT/TUV
- Low cost
- V.32 (9.6 kbps) THT fax/modem "Wet" Transformer ("Wet" means ability to withstand some current.)

SPECIFICATIONS

Part No.	Speed	Impedance(Ω) PRI:SEC	IL (dB)	RL (dB)	LL (mH)	DCR (Ω) PRI:SEC	DC Current PRI (mA DC)
MIT6120	V.32	600:301	3.75	17	11	152/152	65
MIT4115V	V.32	600:470	2.65	14	7.5	110/128	100

- MIT4115V Approved By TDK use for 73M2901, 73M2901cand 73C 2901CL chip.

STB/FAX/MODEM TRANSFORMERS

CMT97B

● DIMENSIONS(mm)

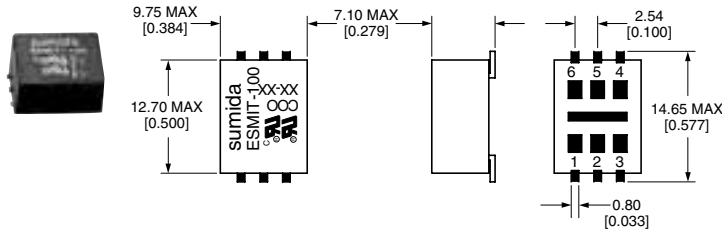

● LAND PATTERNS(mm)

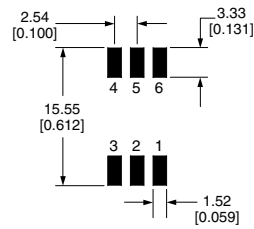

● SCHEMATICS

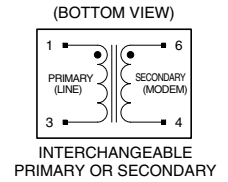

◆ FEATURES

- Internationally Safety Approved for Reinforced Isolation
- EN 60950/BABT/ÜV
- V.92 (56kbps) to V.32 bis (14.4kbps) encapsulated SMT fax/modem transformer

● SPECIFICATIONS

Part No.	Speed	Impedance(Ω) PRI:SEC	THD@600Hz (dB)	IL (dB)	RL (dB)	LL (mH)	DCR (Ω) PRI:SEC
ESMIT3300	V.92	600:260	-89	3.50	20	10.3	180/180
ESMIT3181	V.92	600:280	-90	4.60	20	9.3	235/260
ESMIT300	V.92	600:330	-84	2.50	22	7.5	150/150
ESMIT190	V.32bis	600:420	-78	1.85	21	4.6	90/90
ESMIT100	V.32bis	600:390	-80	2.0	24	5.6	115/115

CBM5D20

● DIMENSIONS(mm)

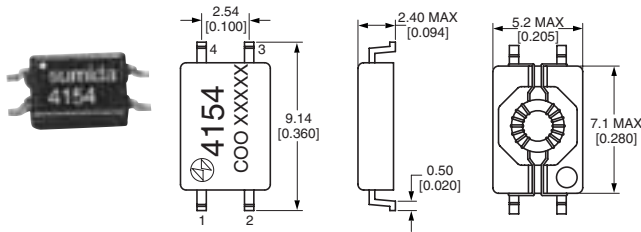

● LAND PATTERNS(mm)

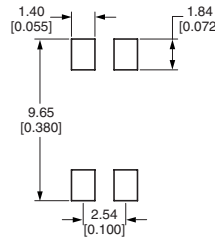

● SCHEMATICS

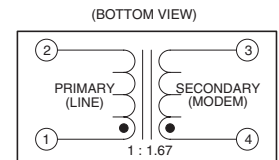

◆ FEATURES

- EN 60950/BABT/ÜV
- V.92 (56kbps) Digital Isolation Barrier for Conexant DAAs

● SPECIFICATIONS

Part No.	Speed	Turns Ratio	LsPRI@100kHz Min. (μH)	Cww (pF)	Self Res IR (MHz)	D.C.R.(Ω) PRI/SEC
EMIT4152	V.92	1:2.6	40	4	8.0	0.250/0.450
EMIT4153	V.92	1:2.0	40	4	8.0	0.250/0.450
EMIT4155	V.92	1:1.67	30 (at 10kHz)	3	8.0	0.250/0.325

CBM5D33

● DIMENSIONS(mm)

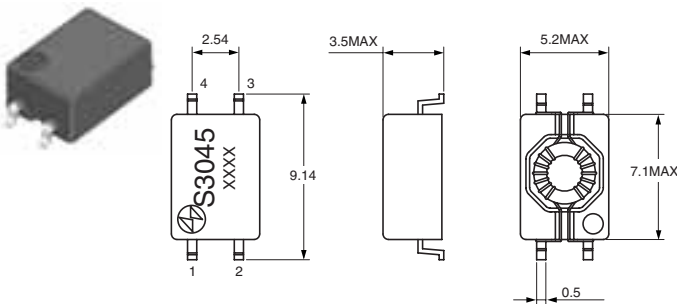

● LAND PATTERNS(mm)

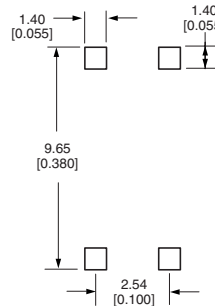

● SCHEMATICS

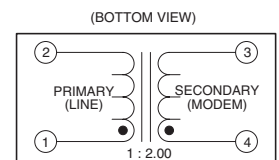

◆ FEATURES

- Safety standard approved
- V.92 (56 kbps) Digital Isolation Barrier for Conexant DAAs

● SPECIFICATIONS

Part No.	Speed	Turns Ratio	LsPRI@100kHz Min. (μH)	D.C.R.(Ω) PRI/SEC
ESMIT4163	V.92	1:2.0	40	0.250/0.450
ESMIT4165	V.92	1:1.67	30(at 10KHz)	0.250/0.325

STB/FAX/MODEM TRANSFORMER

MT1910

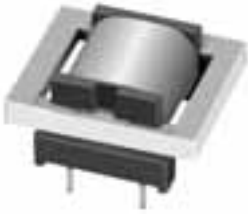

● DIMENSIONS (mm)

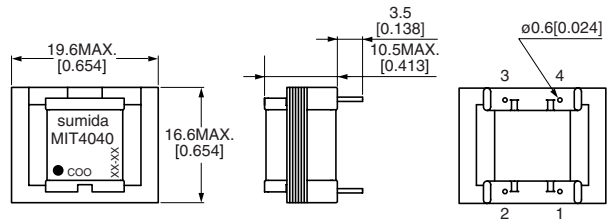

● TERMINAL LAYOUT

● SCHEMATICS

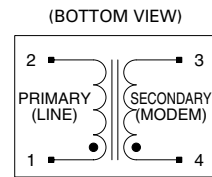
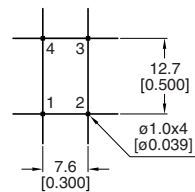
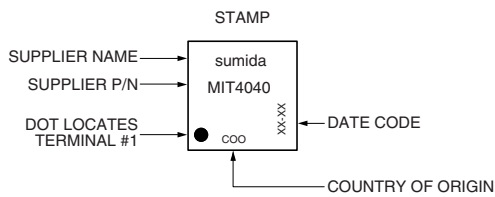

◆ FEATURES

- V.32 (9.6kbps) THT fax/modem "Dry" Transformer. ("Dry" means un-ability to withstand Current).

● SPECIFICATIONS

PARAMETERS	CONDITIONS	MIN	TYP	MAX	UNITS
Impedance	Reflected on Primary	-	600	-	Ohms
	With Load on Secondary	-	530	-	Ohms
Total Harmonic Distortion	@ 600 Hz, -10 dBm	-	-80	-	dB
Insertion Loss	Per IEEE method; @ 1000 Hz	-	-	1.00	dB
Dielectric Rating	1 Minute	1500	-	-	Vrms
	Trip Leakage Current	-	-	200	μA
DC Resistance @ 20°C, ± 10 %	Primary Winding	-	37	-	Ohms
	Secondary Winding	-	37	-	Ohms
DC Current in Primary	-	-	0	-	mADC
Turns Ratio	Primary to Secondary; ± 2%	-	1 : 1	-	-

STB/FAX/MODEM TRANSFORMERS

MIT-6101/MIT-6225 style



● DIMENSIONS(mm)

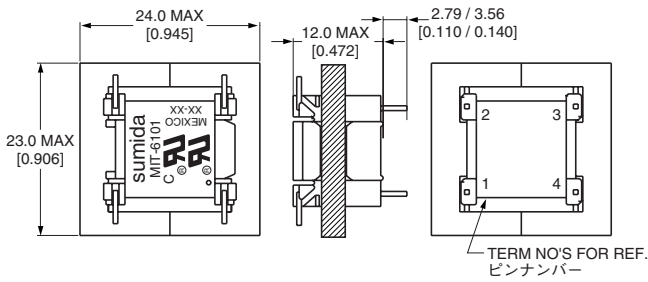

● TERMINAL LAYOUT

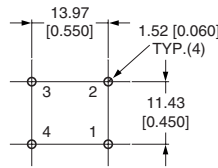

● SCHEMATICS

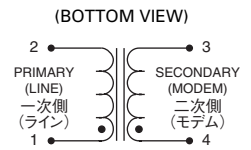

● SPECIFICATIONS

Part No.	Speed	Impedance(Ω) PRI:SEC	THD@600Hz (dB)	IL (dB)	RL (dB)	LL (mH)	D.C.R (Ω) PRI:SEC	DC Current PRI (mA DC)
MIT-6101	V.32	600:260	- 60.0	3.5	8.0	19.0	170/170	50(Typ)
MIT-6225	V.34	600:260	- 79.0	3.3	10.0	19.0	170/170	50(Typ)

MIT-4177 style



● DIMENSIONS(mm)

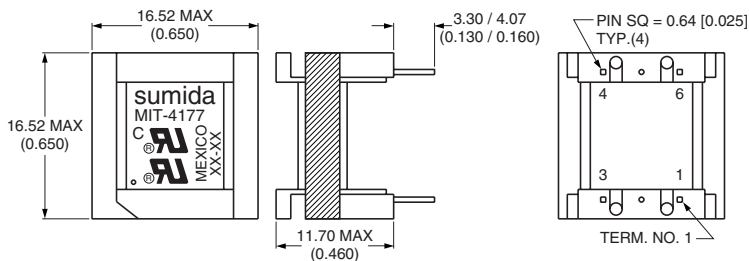

● TERMINAL LAYOUT

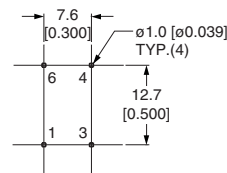

● SCHEMATICS

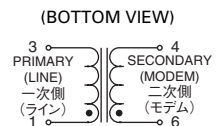

● SPECIFICATIONS

Part No.	Speed	Impedance(Ω) PRI:SEC	THD@600Hz (dB)	IL (dB)	RL (dB)	LL (mH)	DCR (Ω) PRI:SEC
MIT-4177	V.92/V.90	600:301	- 95.0	3.0	18.0	7.8	135/135
MIT-3177	V.92/V.90	600:301	- 92.0	2.6	20.0	3.3	150/150

STB/FAX/MODEM TRANSFORMERS

STB/FAX/MODEM TRANSFORMERS

MT1812B



● DIMENSIONS (mm)

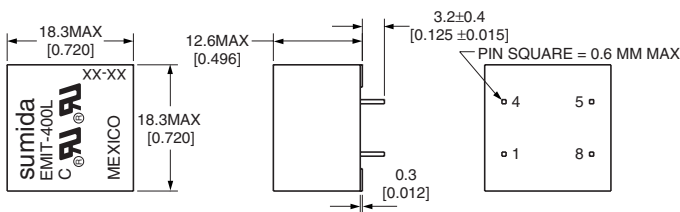

● TERMINAL LAYOUT

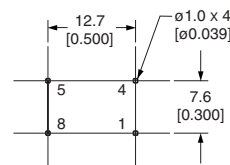

● SCHEMATICS

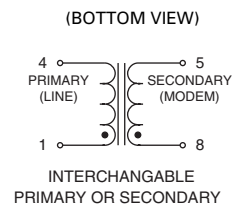

● SPECIFICATIONS

Part No.	Speed	Impedance(Ω) PRI:SEC	THD@600Hz (dB)	IL (dB)	RL (dB)	LL (mH)	D.C.R (Ω) PRI:SEC
EMIT-2001L	V.92/V.90	600:560	- 93.0	1.2	18.0	16.0	67/67
EMIT-2050L	V.92/V.90	600:560	- 87.0	1.55	17.0	17.0	70/70
EMIT-200L	V.34	600:560	- 85.0	1.6	17.5	17.0	70/70
EMIT-1250L	V.34	600:560	- 84.0	1.2	18.0	15.7	67/67
EMIT-200L	V.32bis	600:560	- 74.0	1.5	14.0	12.1	67/67
EMIT-400L	V.32bis	600:600	- 62.0	1.8	14.0	15.0	70/70

MT1812



◆ FEATURES

- Internationally Safety Approved for Reinforced Isolation
- EN 60950/BABT/TÜV
- V.92 (56kbps) to V.32 bis (14.4kbps) encapsulated THT fax/modem transformer

● DIMENSIONS (mm)

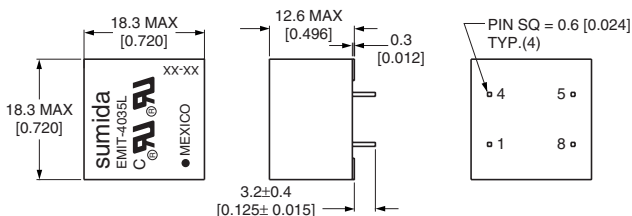

● TERMINAL LAYOUT

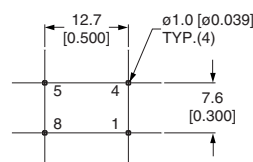

● SCHEMATICS

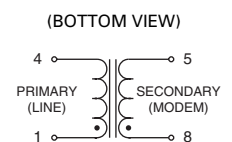

● SPECIFICATIONS

Part No.	Speed	Impedance(Ω) PRI:SEC	THD@600Hz (dB)	IL (dB)	RL (dB)	LL (mH)	D.C.R (Ω) PRI:SEC
EMIT-4035L	V.92/V.90	600:420	- 92.0	1.55	22.0	2.7	82/106
EMIT-4031L	V.32	600:600	- 73.0	1.1	18.0	1.1	55/62

LAN PULSE TRANSFORMERS

OUTLINE

This is very low profile SMD pulse transformer.
This is used whether pulse transformer or common mode choke coil.

CLP42

DIMENSIONS (mm)

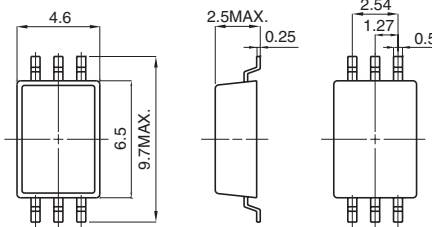

CLP82

DIMENSIONS (mm)

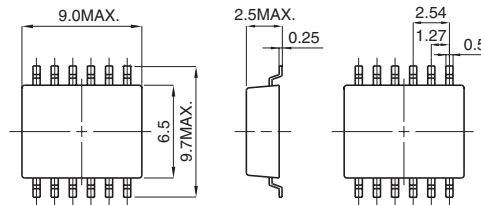

SPECIFICATIONS

Part No.	Turns ratio (±5%)	Inductance (μH)	Leakage inductance Max.(μH)	Line capacitance Max. (pF)	D. C. R Max. (Ω)	ET-product Min. (μSec · V)
CLP42-500	1 : 1	50	0.3	6.0	0.25	0.8
CLP42-750	1 : 1	75	0.35	8.0	0.3	1.0
CLP42-101	1 : 1	100	0.3	9.0	0.3	1.1
CLP42-151	1 : 1	150	0.3	10.0	0.3	1.3
CLP42-201	1 : 1	200	0.3	10.0	0.3	1.5
CLP82-401	TX:RX 1CT:1CT	400	0.25	10.0	0.7	1.2

SPECIFICATIONS

These are very low profile SMD pulse transformers used in PCMCIA cards.
CLP42 : Built in either one pulse transformer or one common-mode choke coil.
CLP82 : Built in either two or three pulse transformers or two or three common-mode choke coils.

10/100 BASE PULSE TRANSFORMERS

OUTLINE

This is a pulse transformer + filter module for LAN 10/100Base-T (IEEE802.3).

CLP11D30



DIMENSIONS (mm)

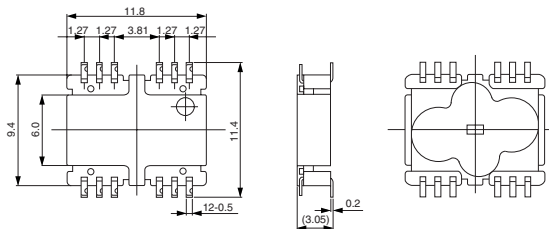

SCHEMATICS

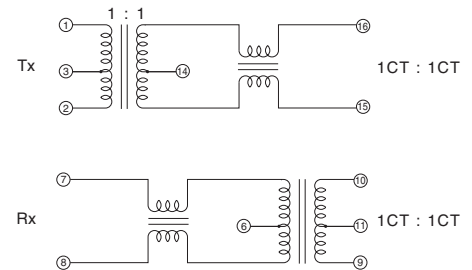

ELECTRICAL SPECIFICATIONS

Operating frequency	f=0.1~100MHz
Inductance	350μH or more (f=100kHz, 0.5V)
Insertion Loss	1.0dB below (f=0.1=100MHz)
Return Loss	16dB or more (f=30MHz)
Differential to common mode rejection	40dB or more (f=30MHz)
Crosstalk	40dB or more (f=30MHz)
Voltage Isolation	AC1650V 6sec.

LAND PATTERNS (mm)

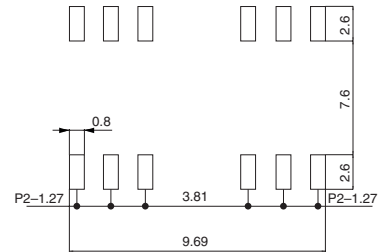

CLP236

DIMENSIONS (mm)

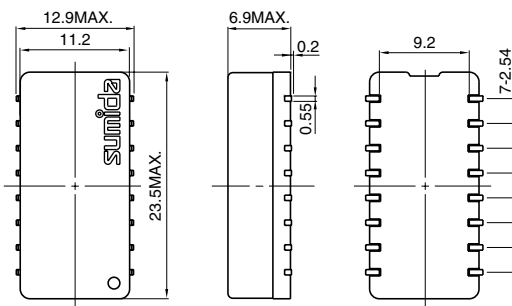

SCHEMATICS

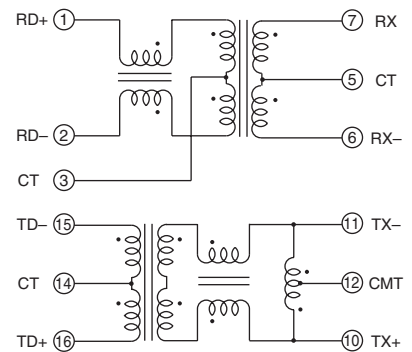

ELECTRICAL SPECIFICATIONS

		RX	TX
Insertion Loss	(0.1~100MHz)	1.0dB Max.	1.0dB Max.
Return Loss	(0.1~60MHz)	19dB typ.	18dB typ.
	(60~100MHz)	14dB typ.	14dB typ.
Differential to common mode rejection ratio	(0.1~60MHz)	43dB Min.	43dB Min.
	(60~100MHz)	40dB Min.	40dB Min.
Inductance	(100KHZ)	350μH Min.	
Voltage Isolation		1500 Vrms Min. For 1 Minute	

Part No.	Turns Ratio	
	RX	TX
SD68515	1CT : 1CT	1CT : 1CT
SD68517	1CT : 1CT	1CT : 1CT
SD49783	1CT : 1CT	1.4CT : 1CT
SD1013	1CT : 1CT	1.4CT : 1CT
SD49743	1CT : 1CT	2CT : 1CT

This filter module is used in LAN 10/100 BASE-T (IEEE802.3) of Personal Computer cards.

RADIO CONTROL CLOCK ANTENNAS

OUTLINE

It is the radio controlled clock antenna with capacitor which is already preset for resonant frequency.

ACL27

DIMENSIONS(mm)

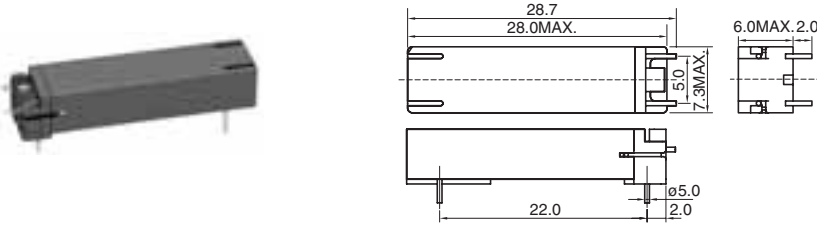

SPECIFICATIONS

Part No.	Tuning Frequency	Tuning Impedance	Sensitivity		
			(60dB μ V/m)	(50dB μ V/m)	(40dB μ V/m)
ACL27-40	40.0 \pm 0.20kHz within	Min. 80k Ω	8.91 μ V (output volt)	2.64 μ V	0.89 μ V
ACL27-60	60.0 \pm 0.20kHz within	Min. 65k Ω	11.03 μ V	3.26 μ V	1.10 μ V

ACL80A/B

DIMENSIONS(mm)

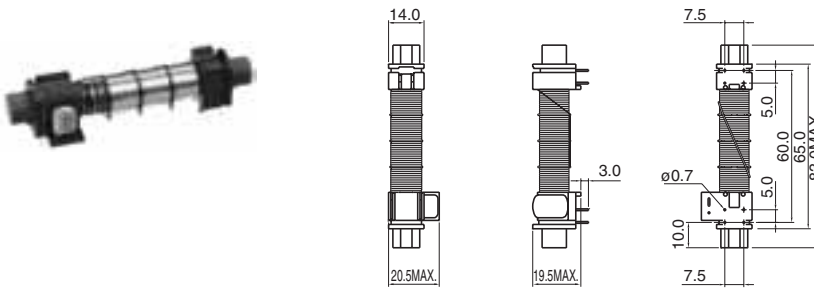

SPECIFICATIONS

Part No.	Spec. No.	Inductance	Resonant Capacitor	Resonant Frequency	Suitable IC
40K08S	S-074-094	588 μ H	27000pF	40kHz, 60kHz	LA1650

Resonant frequencies (40kHz, 60kHz) are preset by suitable inductance and capacitors

AUDIO FILTERS

TYPE	DIMENSIONS(mm)			CONSTRUCTION	SPECIFICATIONS
CFB-6 					1. By combining 1 to 2 pieces, various kinds of LC filter combinations are possible. ※CFB-6,CFB2-6 2. Low profile type (7.5 mm Max.) ※CFB-6,CFB2-6 3. Two capacitors are able to be built in 1coil, therefore an additional capacitor is unnecessary. 4. Surface mounting on PCB and reflow soldering is possible ※CFB-6,CFB2-6
CFB2-6 					
FB-7DG 					

VIDEO FILTERS











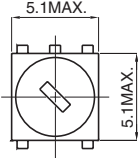
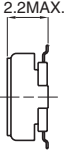
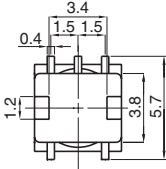

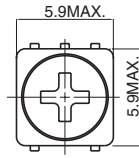
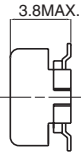
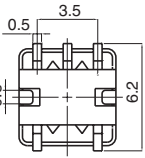

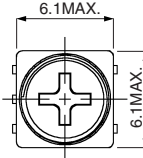
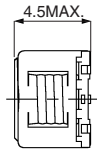
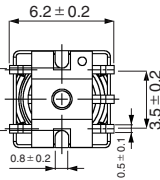

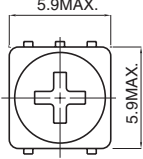
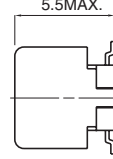
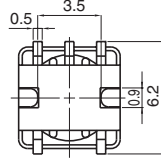

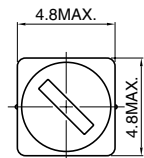
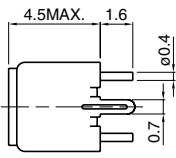
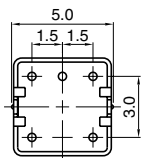
TYPE	DIMENSIONS(mm)			CONSTRUCTION	SPECIFICATIONS
CY-4 					1. Filter with shield case 2. From 1 to 3 pieces combinations are possible for low pass, high pass, band pass and delay lines 3. Low profile (H: 5.2MAX mm) 4. Two capacitors are able to be built in 1 coil. 5. Reflow soldering is possible.
CY-4W 					
CY-4T 					

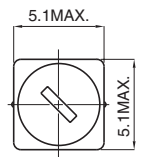
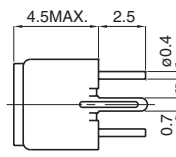
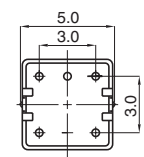
● SPECIFICATIONS

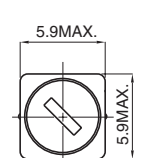
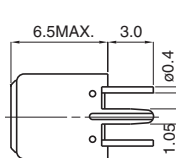
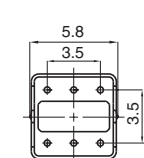

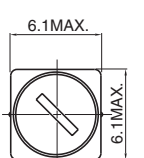
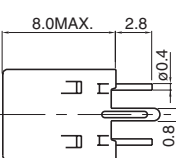
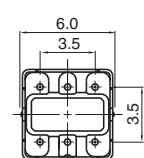
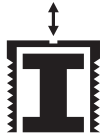

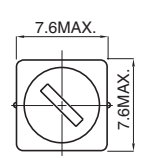
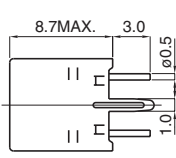
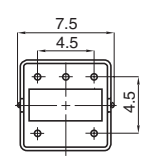





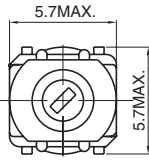
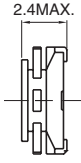
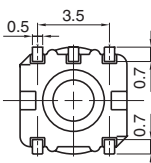

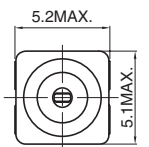
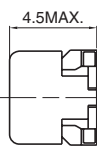
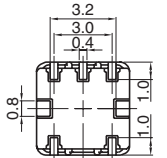

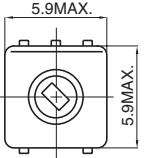
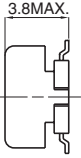
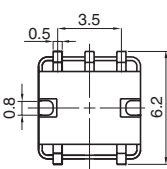

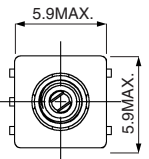
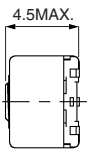
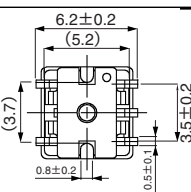
Parts No.	Application	Type	Impedance Rin : Rout	Electric characteristics		
				Cut-off Freq	Delay time	Attenuation
2567-021	1.5MHz L. P. F.	CY-4	1kΩ : 1kΩ	1.5MHz (at 3.0dB)	320nS at 1.0MHz	Min. 23dB (at 3.0 MHz) Min. 40dB (at 5.0 MHz)
2569-T033	3.81MHz L. P. F.	CY-4W	1kΩ : 1kΩ	3.81MHz (at 3.0dB)	140nS at 3.0MHz	Min. 25dB (at 4.8 MHz) Min. 35dB (at 9.5 MHz)
2569-T021	10MHz L. P. F.	CY-4W	1kΩ : 1kΩ	10MHz (at 2.5dB)	32nS at 0.2MHz	Min. 45dB (at 12.2 MHz) Min. 51dB (at 14.3 MHz)
2567-026	5.06MHz B. P. F.	CY-4	1kΩ : 1kΩ	4.85MHz (at 3.0dB) 5.25MHz (at 3.0dB)	—	Min. 20dB (at 3.8 MHz) Min. 17dB (at 6.3 MHz)
2567-034	4.21MHz B. P. F.	CY-4	1kΩ : 1kΩ	4.01MHz (at 2.5dB) 4.41MHz (at 2.5dB)	—	Min. 25dB (at 2.94MHz) Min. 17dB (at 5.47MHz)
2570-T007	10.7MHz B. P. F.	CY-4T	330Ω : 330Ω	10.2MHz (at 2.5dB) 11.2MHz (at 2.5dB)	720nS at 10.7MHz	Min. 15dB (at 9.7MHz)
2569-T017	3.58MHz B. P. F.	CY-4W	1kΩ : 1kΩ	2.46MHz (at 3.0dB) 4.7MHz (at 3.0dB)	187nS at 3.58MHz	Min. 15dB (at 1.0MHz) Min. 17dB (at 7.0MHz)

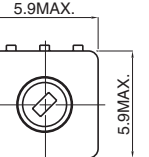
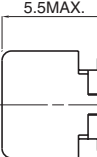
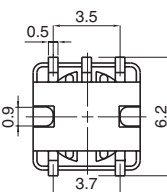
AUDIO / VIDEO FILTERS

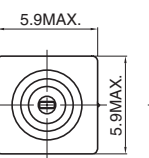
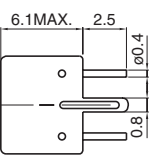
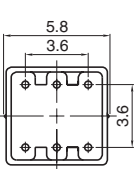
IFT

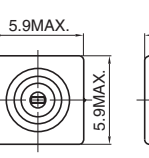
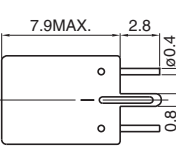
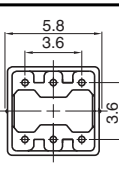
TYPE	DIMENSIONS(mm)			CONSTRUCTION	SPECIFICATIONS
CP-4LB 					Inductance : Max. 246 μ H Operation Freq. : Max. 15MHz Variable range of L : L \pm 1.5%
CP53 					Inductance : Max. 800 μ H Operation Freq. : Max. 15MHz Variable range of L : L \pm 2%
CP54 					Inductance : Max. 1mH Operation Freq. : Max. 20MHz Variable range of L : L \pm 3%
CP55 					Inductance : Max. 1mH Operation Freq. : Max. 15MHz Variable range of L : L \pm 3%
P-4SC 					Inductance : Max. 680 μ H Operation Freq. : Max. 25MHz Variable range of L : L \pm 3%
P-4SB 					Inductance : Max. 680 μ H Operation Freq. : Max. 25MHz Variable range of L : L \pm 3%
P-5DJ 					Inductance : 1 μ H – 680 μ H Operation Freq. : Max. 20MHz Variable range of f & L : f \pm 2%, L \pm 4% Internal capacitors : Max. 470pF Good reliability characteristic Hi Q type
PG57 					Inductance : 1 μ H – 820 μ H Operation Freq. : Max. 20MHz Variable range of f & L : f \pm 2%, L \pm 4% Internal capacitors : Max. 470pF
PG78 					Inductance : 1 μ H – 820 μ H Operation Freq. : Max. 20MHz Variable range of f & L : f \pm 2%, L \pm 4% Internal capacitors : Max. 430pF

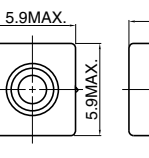
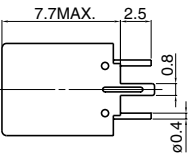
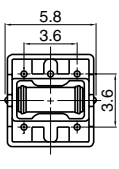
RF COILS

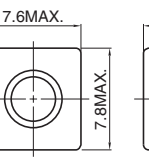
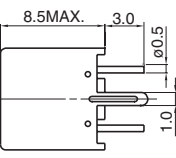
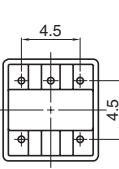
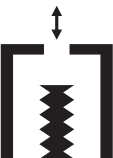
TYPE	DIMENSIONS(mm)			CONSTRUCTION	SPECIFICATIONS
CS-5LN 					Inductance : Max. 1.5 μ H Operation freq. : Max. 150MHz Variable range of L : L \pm 1%
CS-4 					Inductance : Max. 1.0 μ H Operation freq. : Max. 300MHz Variable range of L : L \pm 2%
CS53 					Inductance : Max. 5 μ H Operation freq. : Max. 150MHz Variable range of L : L \pm 1%
CS54 					Inductance : Max. 5 μ H Operation freq. : Max. 150MHz Variable range of L : L \pm 1%
CS55 					Inductance : Max. 5 μ H Operation freq. : Max. 150MHz Variable range of f : f \pm 1% Internal capacitors : Max. 100pF
S-5LE 					Inductance : 0.1 μ H – 1.0 μ H Operation freq. : Max. 300MHz Variable range of L : L \pm 4%
S-5LF 					Inductance : Max. 1.0 μ H Operation freq. : Max. 300MHz Variable range of f & L : f \pm 2%, L \pm 4% Internal capacitors : Max. 56pF
S-5CL3 					Inductance : Max. 30 μ H Operation freq. : Max. 300MHz Variable range of f & L : f \pm 2%, L \pm 4% Internal capacitors : Max. 56pF
S-7LC 					Inductance : 0.1 μ H – 10 μ H Operation freq. : Max. 300MHz Variable range of f & L : f \pm 2%, L \pm 4% Internal capacitors : Max. 100pF

QUADRATURE DETECTOR COILS
QU57

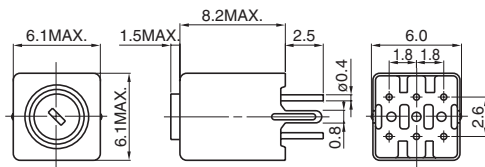
● DIMENSIONS (mm)

● SPECIFICATIONS

Inductance : 0.1 μ H – 25 μ H
 Operation freq. : Max. 15MHz
 Variable range of f : f \pm 1%
 Internal capacitors : Max. 100pF
 Low temperature coefficient

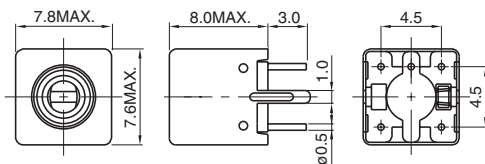
QU-7L

● DIMENSIONS (mm)

● SPECIFICATIONS

Inductance : 0.1 μ H – 25 μ H
 Operation freq. : Max. 30MHz
 Variable range of f : f \pm 1%
 Internal capacitors : Max. 100pF
 High Stability
 Low temperature coefficient

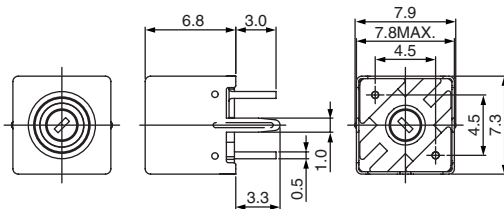
VCO COIL
SM76

● DIMENSIONS (mm)

● SPECIFICATIONS (REFERENCE)

Tuning Capacitance Range (1-2)	10.5pF \pm 2% over variable (at 200MHz)
Unloaded Q	147 (at 200MHz)

Maximum Turn : 3 1/2 T(ϕ 0.5)

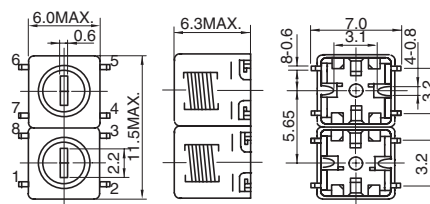
HELICAL FILTER
CH56W

● DIMENSIONS (mm)

● SPECIFICATIONS



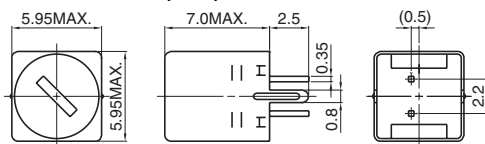



Center Frequency (F0)	480MHz
-1dB Bandwidth at F0	Min.18MHz
Attenuation F0+80MHz	Min.25dB
Attenuation F0-80MHz	Min.19dB
Insertion Loss	Max.3.5dB
Ripple in Passband	Max.1dB

ANTENNA LOADING COIL
MG56

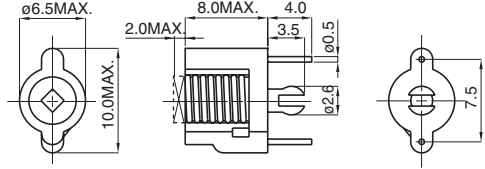
● DIMENSIONS (mm)

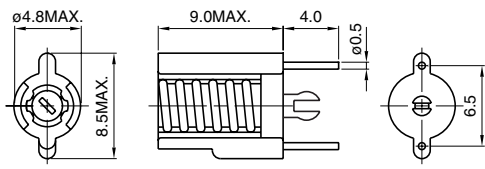
● SPECIFICATIONS

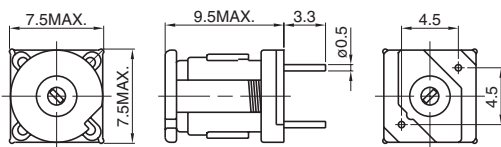





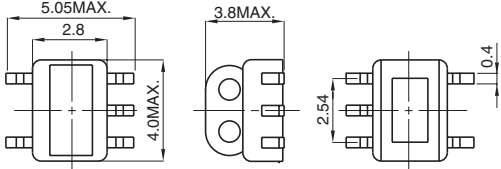

High inductance type used in LW band with high sensitivity

MOLD COILS

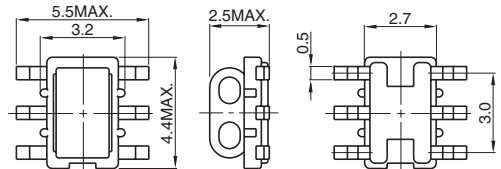

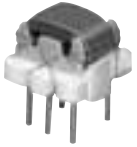
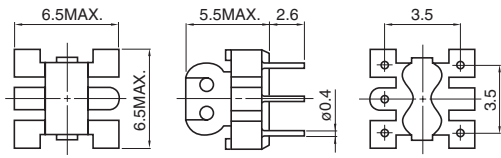

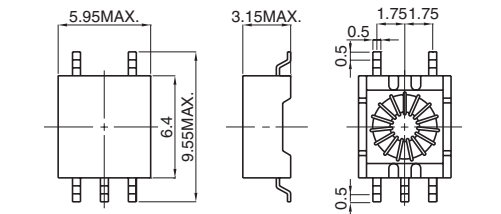
TYPE	DIMENSIONS(mm)	CONSTRUCTION	SPECIFICATIONS
FEM-10BL 			Inductance : 0.05 μ H – 0.1 μ H Operation Freq. : Max. 200MHz Variable range of L : L \pm 3%
FEM-85B 			Inductance : 0.05 μ H – 0.13 μ H Operation Freq. : Max. 200MHz Variable range of L : L \pm 3%
FEM-7BLN 			Inductance : 0.05 μ H – 0.1 μ H Operation Freq. : Max. 200MHz Variable range of L : L \pm 3%

MOLD COILS, BALUN

BALUN

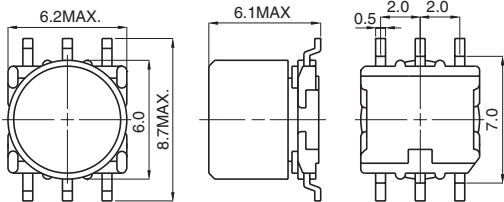

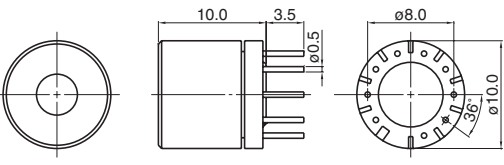







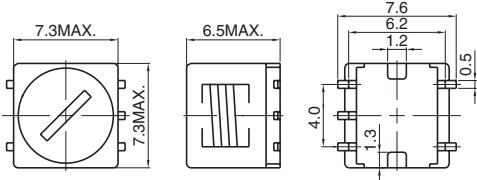
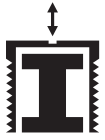

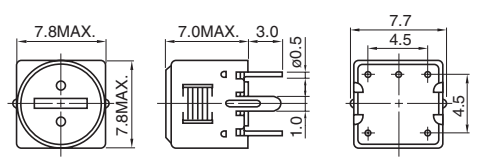
TYPE	DIMENSIONS(mm)	CONSTRUCTION	SPECIFICATIONS
CBM33 			Operation Freq. : 50MHz – 1GHz
CBM42 			Operation Freq. : 100kHz – 1GHz
BM-6N 			Operation Freq. : Max. 500MHz
CBM63 			Operation Freq. : 100kHz – 1GHz

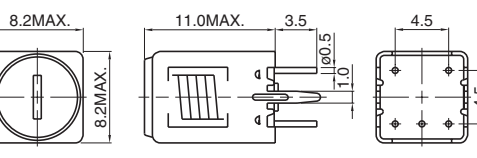
FIXED INDUCTORS FOR TAPE RECORDER

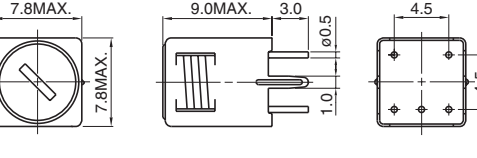
TYPE	DIMENSIONS(mm)	CONSTRUCTION	SPECIFICATIONS
CMS65 			Inductance : Max. 10mH Operation Freq. : Max. 500kHz Max. operation power : 300mW(100kHz) 610mW(200kHz) 910mW(300kHz)
MC-102 			Inductance : Max. 80mH Operation Freq. : Max. 400kHz

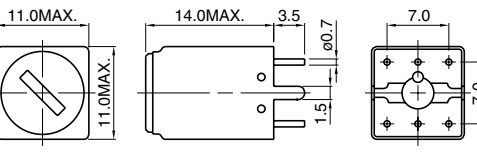
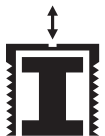
FIXED INDUCTORS FOR TAPE RECORDER

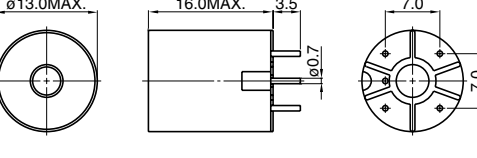
VARIABLE INDUCTORS

TYPE	DIMENSIONS(mm)	CONSTRUCTION	SPECIFICATIONS
CMG65 			Inductance : Max. 27mH Operation freq. : 10 – 250kHz Variable range of L : L±10%
M-7GLB 			Inductance : Max. 4.5mH Operation freq. : Max. 250kHz Variable range of L : L±5%
M-8G 			Inductance : Max. 27mH Operation freq. : Max. 500kHz Variable range of L : L±8%
MG78 			Inductance : Max. 100mH Operation freq. : Max. 500kHz Variable range of L : L±5%
M-10B 			Inductance : Max. 20mH Operation freq. : Max. 500kHz Variable range of L : L±10%
MC-129J 			Inductance : Max. 82mH Operation freq. : Max. 250kHz Variable range of L : L±10%

VARIABLE INDUCTORS

Sparctube™ - SWITCHING SPARK GAPS

OUTLINE

Sparctube™ is a range of switching spark gaps designed specifically for voltage controlled switching of capacitive discharge circuits, where a high energy, low loss, and a fast rate of switching is required. Ideally suited to applications where a capacitive discharge is utilised with a transformer to obtain pulses of very high voltage levels in the order of several thousand volts.



APPLICATIONS / 適用

- Igniters for Architectural and Automotive Xenon discharge lamps
- Ignition of Ultra High Pressure Gas Discharge Lamps for Data and Video Projectors
- Electronic Igniters for Gas Heating and Gas Domestic Appliances, e.g. Cookers
- Ignition Control for Plasma Discharge Welders

TYPICAL DATA

- Product Voltage Range220 - 2000V
- Switching Time< 50ns
- Switching Current< 1000A
- Energy Per Discharge< 200mJ
- Service Life (operations)> 200,000*
- Arc Voltage10 - 100V

FEATURES / 特徴

- Fast Switching Rate
- High Energy Low Loss Capability
- Wide Operating Temperature Range
- Excellent Service Life
- High Insulation Resistance
- Small Size
- Rugged Ceramic Metal Construction
- Non Radioactive

SPECIFICATIONS

Product Code	Switching Voltage	Switching Frequency	Insulation Resistance	Capacitance	Operating Temperature
ST 0220	220V	<400Hz	>100 M	<2 pF	-40 ~ +160 °C
ST 0350	350V	<400Hz	>100 M	<2 pF	-40 ~ +160 °C
ST 0400	400V	<400Hz	>100 M	<2 pF	-40 ~ +160 °C
ST 0600	600V	<400Hz	>100 M	<2 pF	-40 ~ +160 °C
ST 0800*	800V	<400Hz	>100 M	<2 pF	-40 ~ +160 °C
ST 1000	1000V	<400Hz	>100 M	<2 pF	-40 ~ +160 °C
ST 2000	2000V	<400Hz	>100 M	<2 pF	-40 ~ +160 °C

*ST 0800 is available with a service life > 1,000,000 switchings.

Sparctube™ is a trademark of Jensen Devices AB.

NEW PRODUCTS

Sparctube™ - SWITCHING SPARK GAPS

■ BASIC APPLICATION CIRCUIT

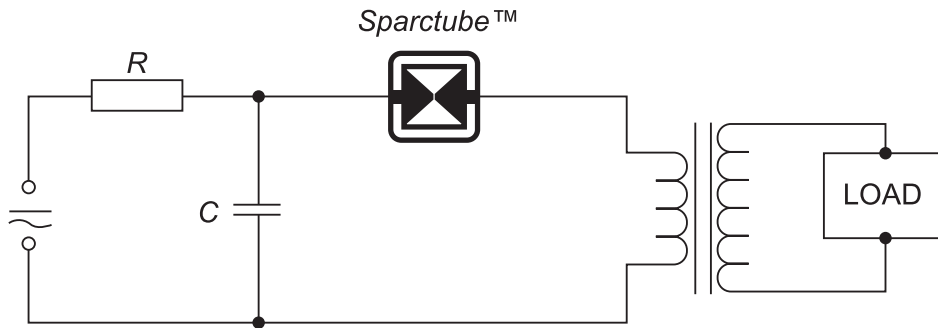

■ MECHANICAL DIMENSIONS

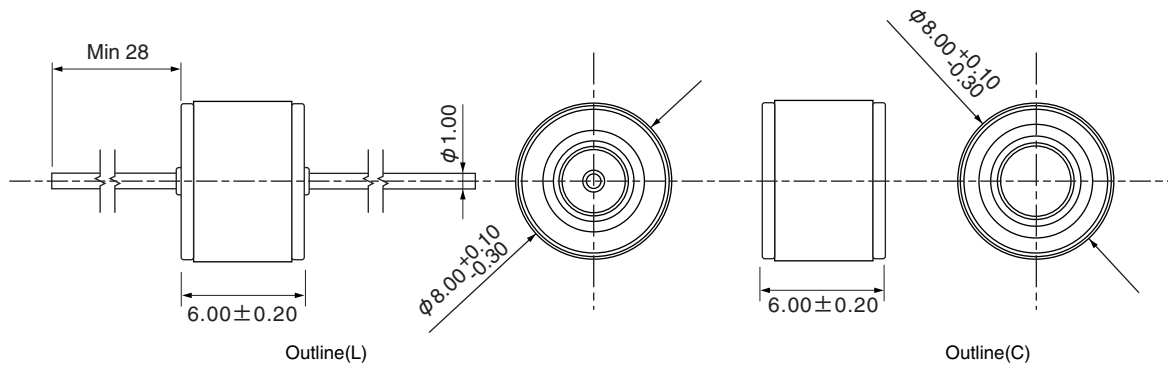

■ ORDERING INFORMATION

ST XXXXX X X - STD

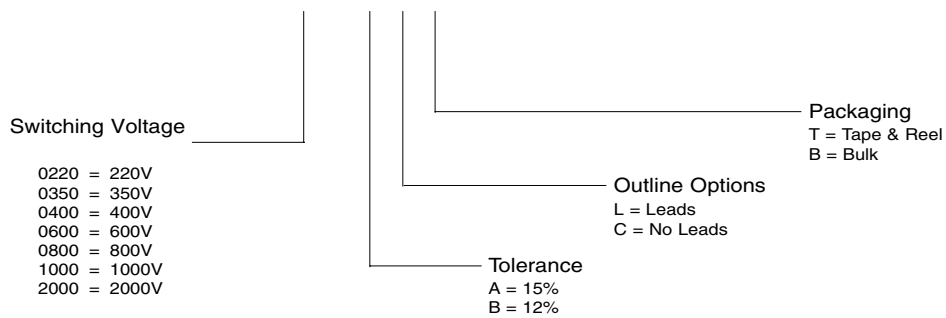

Sparctube™ is a trademark of Jensen Devices AB.

Dimensions for embossed tape and reel packing with packed QTY

Tape Dimensions (mm)

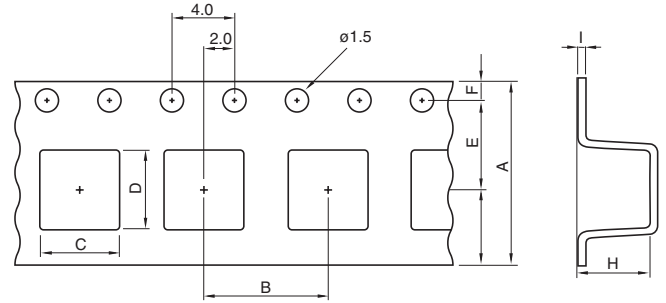

TYPE	DIMENSION(mm)								QYT (PCS/Reel)
	A	B	C	D	E	F	H	I	
CAS14D26	24.0	8.0	5.6	15.0	11.5	1.75	3.0	0.4	2000
CBM33	12.0	8.0	4.4	5.6	5.5	1.75	3.3	0.4	500
CBM42	12.0	8.0	4.8	5.8	5.5	1.75	2.8	0.4	500
CBM63	16.0	8.0	6.1	10.3	7.5	1.75	3.3	0.4	500
CDBM7D28	16.0	4.0	5.1	8.1	7.5	1.75	3.1	0.4	2000
CDC5D23	12.0	8.0	6.0	6.0	5.65	1.50	2.6	0.4	2000
CDEP104(L.S)	24.0	16.0	10.5	10.5	11.5	1.75	5.8	0.4	500
CDEP105(L.S.H)	24.0	16.0	10.5	10.5	11.5	1.75	5.8	0.4	500
CDEP134(H)	24.0	16.0	14.1	14.1	11.5	1.75	5.2	0.4	500
CDEP149	24.0	24.0	15.1	15.1	11.5	1.75	10.3	0.4	250
CDPH4D19F	12.0	8.0	5.1	5.1	5.65	1.75	2.1	0.4	1000
CDR7D28MN	16.0	12.0	7.6	7.6	7.5	1.75	3.3	0.4	1000
CDRH103R	24.0	16.0	10.4	10.4	11.5	1.75	3.1	0.4	1000
CDRH104R	24.0	16.0	10.4	10.4	11.5	1.75	4.1	0.4	1000
CDRH105R	24.0	16.0	10.4	10.4	11.5	1.75	5.1	0.4	500
CDRH124	16.0	16.0	12.4	12.4	11.5	1.75	4.5	0.5	500
CDRH125	24.0	16.0	12.4	12.4	11.5	1.75	6.0	0.5	500
CDRH127	24.0	16.0	12.4	12.4	11.5	1.75	7.9	0.5	500
CDRH127/LD	24.0	16.0	10.0	12.4	11.5	1.75	7.9	0.5	500
CDRH2D11	12.0	8.0	3.3	3.3	5.5	1.75	1.3	0.4	1500
CDRH2D14	12.0	8.0	3.3	3.3	5.5	1.75	1.6	0.4	1000
CDRH2D18/HP	12.0	8.0	3.3	3.3	5.5	1.75	2.1	0.4	1000
CDRH2D18/LD	12.0	8.0	3.3	3.3	5.5	1.75	2.1	0.4	1000
CDRH3D16	12.0	8.0	4.3	4.3	5.5	1.75	1.9	0.4	1000
CDRH3D16/HP	12.0	8.0	4.3	4.3	5.5	1.75	1.9	0.4	1000
CDRH3D16/LD	12.0	8.0	4.3	4.3	5.5	1.75	1.9	0.4	1000
CDRH3D28	12.0	8.0	4.3	4.3	5.5	1.75	3.1	0.4	500
CDRH3D28/LD	12.0	8.0	4.3	4.3	5.5	1.75	3.1	0.4	500
CDRH4D16F/LD	12.0	8.0	4.6	4.6	5.5	1.75	2.05	0.4	1000
CDRH4D18	12.0	8.0	5.1	5.1	5.65	1.75	2.1	0.4	1000
CDRH4D18C	12.0	8.0	5.1	5.1	5.65	1.75	2.1	0.4	1000
CDRH4D18C/LD	12.0	8.0	5.1	5.1	5.65	1.75	2.1	0.4	1000
CDRH4D22	12.0	8.0	5.1	5.1	5.65	1.75	2.5	0.4	2000
CDRH4D28	12.0	8.0	5.1	5.1	5.6	1.75	3.1	0.4	2000
CDRH4D28C	12.0	8.0	5.1	5.1	5.65	1.75	3.1	0.4	2000
CDRH4D28C/LD	12.0	8.0	5.1	5.1	5.65	1.75	3.1	0.4	2000
CDRH5D16F/LD	12.0	8.0	5.5	5.5	5.5	1.75	2.05	0.4	1000
CDRH5D18	12.0	8.0	6.0	6.0	5.65	1.50	2.1	0.4	2000
CDRH5D28	12.0	8.0	6.0	6.0	5.65	1.50	3.1	0.4	2000
CDRH5D28R	12.0	8.0	6.3	6.4	5.65	1.50	3.1	0.4	2000
CDRH6D12	16.0	12.0	6.8	6.8	7.5	1.75	1.7	0.4	1000
CDRH6D26	16.0	12.0	7.1	7.1	7.5	1.75	3.1	0.4	1500
CDRH6D28	16.0	12.0	7.1	7.1	7.5	1.75	3.1	0.4	1500
CDRH6D38	16.0	12.0	7.1	7.1	7.5	1.75	4.1	0.4	1000
CDRH8D28	16.0	16.0	10.5	8.2	7.5	1.75	3.1	0.4	1000
CDRH8D38	16.0	16.0	8.2	8.2	7.5	1.75	4.1	0.4	1000
CDRH8D43	16.0	16.0	10.5	8.2	7.5	1.75	4.7	0.4	500
CEE156	24.0	24.0	16.9	15.4	11.5	1.75	7.1	0.5	300
CEE-78	24.0	16.0	9.0	9.7	11.5	1.75	6.1	0.5	500
CEE93	24.0	16.0	11.0	12.0	11.5	1.75	4.6	0.5	500
CEE94	24.0	16.0	11.0	12.0	11.5	1.75	4.6	0.5	500
CEE98	24.0	16.0	11.0	12.0	11.5	1.75	6.1	0.5	500
CEI120	24.0	16.0	14.0	15.1	11.5	1.75	6.1	0.5	500
CEI122(H)	24.0	16.0	12.9	12.9	11.5	1.75	3.6	0.4	1000
CEI-128	24.0	16.0	14.0	15.1	11.5	1.75	6.1	0.5	500
CEP123	24.0	16.0	12.9	12.9	11.5	1.75	3.6	0.4	1000

Dimensions for embossed tape and reel packing with packed QTY

TYPE 形名	DIMENSION(mm)								QYT (PCS/Reel)
	A	B	C	D	E	F	H	I	
CEP125(H,U)	24.0	16.0	13.0	13.0	11.5	1.75	5.8	0.4	500
CEP12D38	24.0	16.0	12.9	12.9	11.5	1.75	4.1	0.4	1000
CEPH199	44.0	36.0	26.1	30.6	20.2	1.75	10.1	0.4	100
CER95	24.0	16.0	11.0	12.8	11.5	1.75	6.3	0.5	500
CFB-6	16.0	12.0	7.1	8.2	7.5	1.75	7.6	0.5	500
CFB2-6	24.0	12.0	8.2	13.9	11.5	1.75	7.6	0.5	500
CLP236	32.00	16.0	13.4	23.5	14.2	1.75	7.0	0.3	500
CLP42	16.00	8.0	5.2	9.8	7.5	1.75	2.6	0.4	500
CLP82	16.0	12.0	9.2	9.8	11.5	1.75	2.6	0.4	500
CLQ102	24.0	16.0	11.9	10.9	11.5	1.75	3.1	0.4	1000
CLQ104	24.0	16.0	11.9	10.9	11.5	1.75	4.6	0.4	500
CLQ122	24.0	20.0	12.4	14.0	11.5	1.75	3.1	0.4	500
CLQ143	24.0	20.0	14.9	17.0	11.5	1.75	3.5	0.4	500
CLQ4D27	12.0	8.0	5.0	5.2	5.5	1.75	3.3	0.4	1500
CLQ52	12.0	8.0	6.0	6.4	5.5	1.75	2.6	0.4	1500
CLQ72	16.0	12.0	8.0	7.1	7.5	1.75	3.1	0.4	1500
CLQ72B	16.0	12.0	7.1	8.0	7.5	1.75	3.1	0.4	1500
CLQ7D27	16.0	12.0	8.0	9.9	7.5	1.75	3.1	0.4	1000
CLS10	24.0	16.0	11.4	11.4	11.5	1.75	5.1	0.5	500
CLS12	24.0	16.0	13.8	14.7	11.5	1.75	6.1	0.5	500
CLS4D09	12.0	8.0	5.1	5.1	5.5	1.75	1.5	0.4	1000
CLS4D11	12.0	8.0	5.1	5.1	5.5	1.75	1.5	0.4	1000
CLS4D14	12.0	8.0	5.1	5.1	5.5	1.75	1.7	0.4	1000
CLS5D11	12.0	8.0	6.2	6.2	5.65	1.5	1.5	0.4	1000
CLS5D14	12.0	8.0	6.2	6.2	5.65	1.5	1.7	0.4	1000
CMD4D06	12.0	8.0	6.0	7.0	5.5	1.75	1.5	0.4	1000
CMD4D08	12.0	8.0	6.0	7.0	5.5	1.75	1.7	0.4	1000
CMD4D11	12.0	8.0	4.5	5.9	5.5	1.75	1.5	0.4	1000
CMD4D13	12.0	8.0	4.5	5.9	5.5	1.75	1.7	0.4	1000
CMD5D11	16.0	8.0	5.9	7.5	7.5	1.75	1.5	0.4	1000
CMD5D13	16.0	8.0	5.9	7.5	7.5	1.75	1.8	0.4	1000
CMD6D11B	16.0	12.0	7.3	8.0	7.5	1.75	1.5	0.4	2000
CMG65	16.0	12.0	7.1	8.2	7.5	1.75	6.6	0.5	500
CP-4LB	12.0	8.0	5.2	6.4	5.5	1.75	3.3	0.3	500/2000
CP53	12.0	12.0	7.0	6.0	5.5	1.75	4.3	0.4	1000
CP55	12.0	12.0	7.0	6.0	5.5	1.75	6.0	0.4	750
CPFC74	16.0	8.0	5.9	9.5	7.5	1.75	4.6	0.4	1000
CPFC85	16.0	12.0	8.3	9.3	7.5	1.75	5.5	0.4	1000
CPU9D25	24.0	16.0	10.4	14.2	11.5	1.75	3.2	0.4	1000
CR105	24.0	12.0	9.5	10.4	11.5	1.75	5.9	0.4	500
CR10D37	24.0	16.0	10.4	10.4	11.5	1.75	4.2	0.4	1000
CR32	12.0	8.0	3.75	4.1	5.5	1.75	3.0	0.4	2000
CR43	12.0	8.0	4.4	4.9	5.5	1.75	3.5	0.4	1500
CR54	12.0	8.0	5.7	6.2	5.5	1.75	5.0	0.4	1500
CR75	16.0	12.0	7.4	8.2	7.5	1.75	5.5	0.4	1000
CS-4	12.0	8.0	5.1	5.1	5.65	1.50	4.6	0.4	500/1500
CS53	12.0	12.0	7.0	6.0	5.5	1.75	4.3	0.4	1000
CS55	12.0	12.0	7.0	6.0	5.5	1.75	6.0	0.4	750
CS-5LN	12.0	8.0	5.6	5.6	5.65	1.50	2.6	0.4	500/2500
CY-4	12.0	8.0	5.5	6.5	5.5	1.75	5.3	0.4	1000
CY-4T	24.0	8.0	6.4	14.75	11.5	1.75	5.2	0.4	1000
CY-4W	24.0	8.0	6.4	11.1	11.5	1.75	5.2	0.4	1000

Dimensions for embossed tape and reel packing with packed QTY

■ HEAD OFFICE

Sumida Electric Co., Ltd.

3-3-6, Nihonbashi-Ningyocho, Chuo-ku, Tokyo, Japan, 103-8589
TEL. +81-3-3667-3302 FAX. +81-3-3667-3408

■ OVERSEAS SALES OFFICES

Sumida Trading Company Limited

14 / F., Eastern Centre, 1065 King's Road, Quarry Bay, Hong Kong
TEL. +852-2880-6688 FAX. +852-2565-9600 E-mail : sales@hk.sumida.com

Sumida Trading Company Limited (Munich Office)

Stefan-George-Ring 29, Munich, D-81929 Germany
TEL. +49-89-930-86161 FAX. +49-89-930-86422 E-mail : sales@eu.sumida.com

Taiwan Sumida Electronics Inc. (Taiwan Head Office)

171 Fu Teh St., Hsin-I, Taipei, Taiwan R.O.C.
TEL. +886-22726-2177 FAX. +886-22728-2726 E-mail : sales@tw.sumida.com

Taiwan Sumida Electronics Inc. (Tainan Office)

Room B, 5F, Shan-Hua Building, No. 291 Ta-Cheng Road, Shan-Hua, Tainan County, Taiwan 741
TEL. +886-6-5834836 FAX. +886-6-5834768 E-mail : sales@tw.sumida.com

Taiwan Sumida Electronics Inc. (Hsinchu Office)

Room2, 10F, No.537 Sec.2, Kuang Fu Road, Hsinchu, Taiwan R.O.C.
TEL. +886-3561-0554 FAX. +886-3561-0564 E-mail : sales@tw.sumida.com

Dongguan Sumida (Taiping) Electric Co., Ltd. (Shenzhen Sales Office)

Room 3905, Block A, United Plaza, 5022 Binhe Road, Futian District, Shenzhen, Guangdong, PRC, 518026
TEL. +86-755-82910228 FAX. +86-755-82910338 E-mail : shenzhen.sales@cn.sumida.com

Suzhou Sumida Electric Co., Ltd.

No.15 Dongxing Road, Loufeng Sub-district, Suzhou Industrial Park, Suzhou, Jiangsu, China PRC 215021
TEL. +86-512-6760-9280 FAX. +86-512-6760-9512 E-mail : suzhou.sales@cn.sumida.com

Sumida Europe S.A.

Chaussee de Tervuren 113A, B-1160 Brussels, Belgium
TEL. +32-2673-9565 FAX. +32-2672-0454 E-mail : sales@eu.sumida.com

Sumida Trading Pte Limited

996 Bendemeer Road, #04-05 to 06, Singapore 339944
TEL. +65-6296-3388 FAX. +65-6296-3390 E-mail : sales@sg.sumida.com

SMD Marketing (M) Sdn. Bhd. (Malaysia Head Office)

Suite 704 Level 7, Menara, Apex, Off Jalan Semenyih, Bukit Mewah, 43000 Kajang, Selangor Darul Ehsan, Malaysia
TEL. +60-3-8733-0900 FAX. +60-3-8737-7384 E-mail : sales@my.sumida.com

SMD Marketing (M) Sdn. Bhd. (Penang Office)

Unit 2-08A, Choo Plaza, 41 Lorong Abu Siti, 10400 Penang, Malaysia
TEL. +60-4-228-3505, 229-2650 FAX. +60-4-229-8512 E-mail : sales@my.sumida.com

Sumida America Inc. (U.S.A. Head Office)

1701 West Golf Road, Tower 3, Suite 400, Rolling Meadows, Illinois, IL 60008 U.S.A.
TEL. +1-847-545-6700 FAX. +1-847-545-6720 E-mail : sales@us.sumida.com

Sumida America Inc. (San Jose Office)

2841 Junction Ave., Suite 120, San Jose, CA 95134, U.S.A.
TEL. +1-408-321-9660 FAX. +1-408-321-9308 E-mail : sales@us.sumida.com

Sumida America Inc. (Detroit Office)

Suite 100, 320 East Big Beaver Road, Troy, MI 48084 U.S.A.
TEL. +1-248-528-0095 FAX. +1-248-528-0360 E-mail : sales@us.sumida.com

Jensen Devices AB

Rudbecks Väg 143, 192 51 Sollentuna, Sweden
TEL. +46-(0)8-928895 FAX. +46-(0)8-963315 E-mail : info@jensendevice.com

Jensen Devices AB(Belgium Office)

Industrieweg Noord 1118 Box 8, 3660 Oplabbeek, Belgium
TEL. +32-89-791877 FAX. +32-89-791876 E-mail : info@jensendevice.com

<http://www.sumida.com>

 is a registered trademark of SUMIDA CORPORATION, and may not be used by you without prior written approval.

AGENT