

# International IOR Rectifier

31DQ03  
31DQ04

SCHOTTKY RECTIFIER

3.3 Amp

### Major Ratings and Characteristics

Characteristics	31DQ..	Units
$I_{F(AV)}$ Rectangular waveform	3.3	A
$V_{RRM}$	30/40	V
$I_{FSM}$ @ $t_p = 5 \mu s$ sine	450	A
$V_F$ @ 3 Apk, $T_J = 25^\circ C$	0.57	V
$T_J$	-40 to 150	$^\circ C$

### Description/Features

The 31DQ.. axial leaded Schottky rectifier has been optimized for very low forward voltage drop, with moderate leakage. Typical applications are in switching power supplies, converters, free-wheeling diodes, and reverse battery protection.

- Low profile, axial leaded outline
- High purity, high temperature epoxy encapsulation for enhanced mechanical strength and moisture resistance
- Very low forward voltage drop
- High frequency operation
- Guard ring for enhanced ruggedness and long term reliability

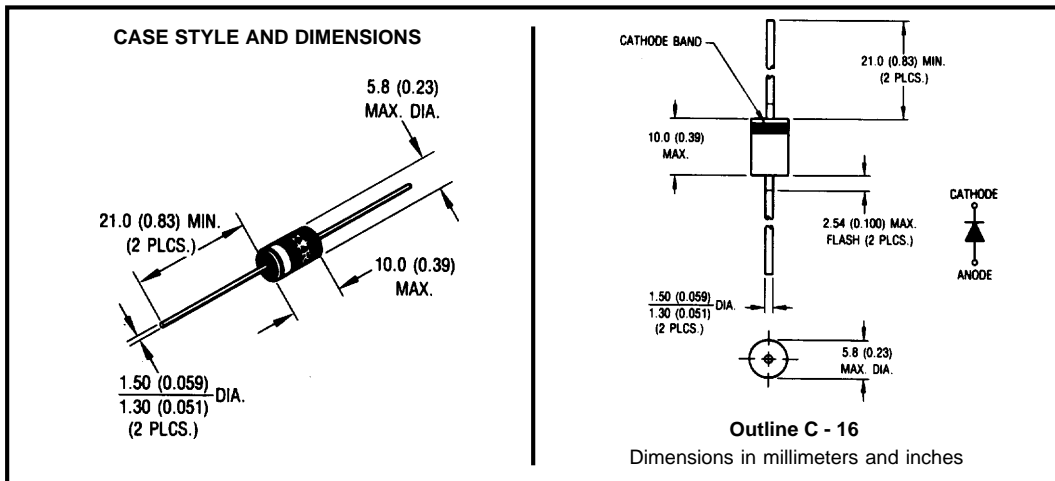

## Voltage Ratings

Part number	31DQ03	31DQ04
$V_R$ Max. DC Reverse Voltage (V)	30	40
$V_{RWM}$ Max. Working Peak Reverse Voltage (V)		

## Absolute Maximum Ratings

Parameters	31DQ..	Units	Conditions
$I_{F(AV)}$ Max. Average Forward Current * See Fig. 4	3.3	A	50% duty cycle @ $T_C = 73^\circ\text{C}$ , rectangular wave form
$I_{FSM}$ Max. Peak One Cycle Non-Repetitive Surge Current * See Fig. 6	450	A	5 $\mu\text{s}$ Sine or 3 $\mu\text{s}$ Rect. pulse
	90		10ms Sine or 6ms Rect. pulse
$E_{AS}$ Non-Repetitive Avalanche Energy	6.0	mJ	$T_J = 25^\circ\text{C}$ , $I_{AS} = 1.0$ Amps, $L = 12$ mH
$I_{AR}$ Repetitive Avalanche Current	1.0	A	Current decaying linearly to zero in 1 $\mu\text{sec}$ Frequency limited by $T_J$ max. $V_A = 1.5 \times V_R$ typical

## Electrical Specifications

Parameters	31DQ..	Units	Conditions
$V_{FM}$ Max. Forward Voltage Drop * See Fig. 1 (1)	0.57	V	@ 3A
	0.71	V	@ 6A
	0.51	V	@ 3A
	0.62	V	@ 6A
$I_{RM}$ Max. Reverse Leakage Current * See Fig. 2 (1)	1	mA	$T_J = 25^\circ\text{C}$
	20	mA	$T_J = 125^\circ\text{C}$
$C_T$ Typical Junction Capacitance	190	pF	$V_R = 5V_{DC}$ (test signal range 100Khz to 1Mhz) $25^\circ\text{C}$
$L_S$ Typical Series Inductance	9.0	nH	Measured lead to lead 5mm from package body
dv/dt Max. Voltage Rate of Change	10000	V/ $\mu\text{s}$	(Rated $V_R$ )

(1) Pulse Width < 300 $\mu\text{s}$ , Duty Cycle <2%

## Thermal-Mechanical Specifications

Parameters	31DQ..	Units	Conditions
$T_J$ Max. Junction Temperature Range (*)	-40 to 150	$^\circ\text{C}$	
$T_{stg}$ Max. Storage Temperature Range	-40 to 150	$^\circ\text{C}$	
$R_{thJA}$ Max. Thermal Resistance Junction to Ambient	80	$^\circ\text{C}/\text{W}$	DC operation Without cooling fins
$R_{thJL}$ Typical Thermal Resistance Junction to Lead	34	$^\circ\text{C}/\text{W}$	With fin 20 x 20 (0.79 x 0.79) 1.0 (0.04) thick. Dimensions in millimeters (inches)
wt Approximate Weight	1.2 (0.042)	g (oz.)	
Case Style	C - 16		

(\*)  $\frac{dP_{tot}}{dT_J} < \frac{1}{R_{th(j-a)}}$  thermal runaway condition for a diode on its own heatsink

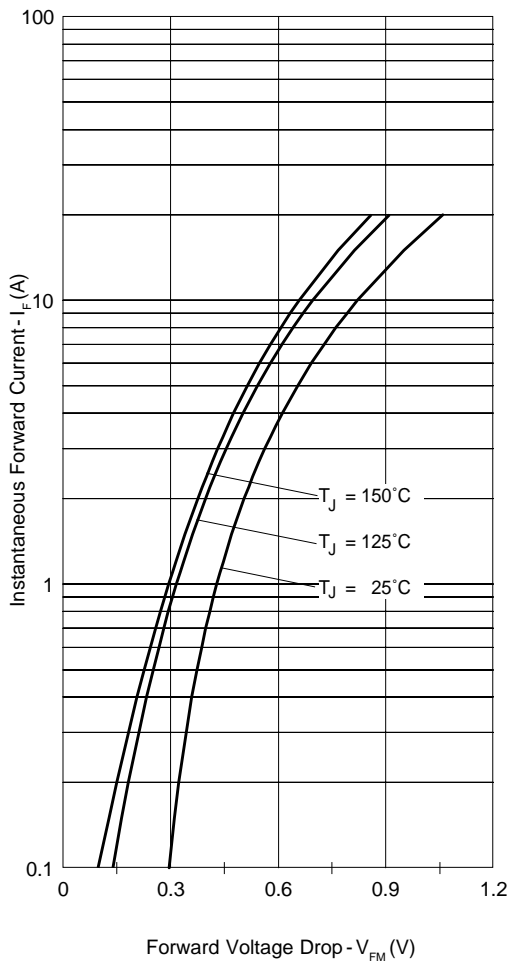

**Fig. 1 - Max. Forward Voltage Drop Characteristics**

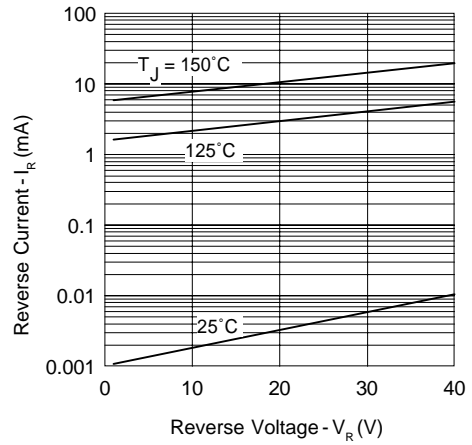

**Fig. 2 - Typical Values Of Reverse Current Vs. Reverse Voltage**

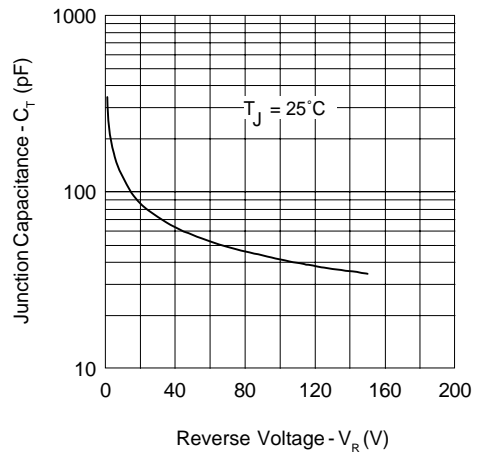

**Fig. 3 - Typical Junction Capacitance Vs. Reverse Voltage**

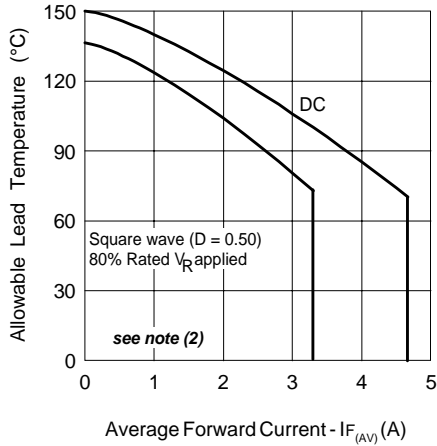

**Fig. 4 - Max. Allowable Lead Temperature Vs. Average Forward Current**

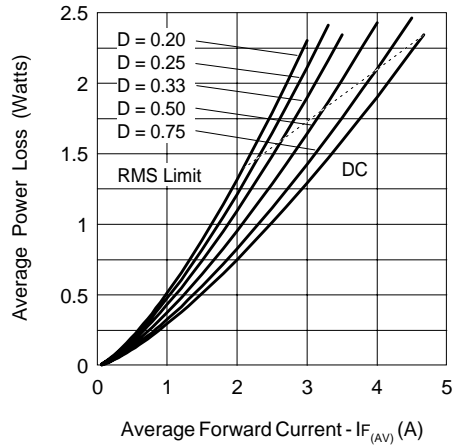

**Fig. 5 - Forward Power Loss Characteristics**

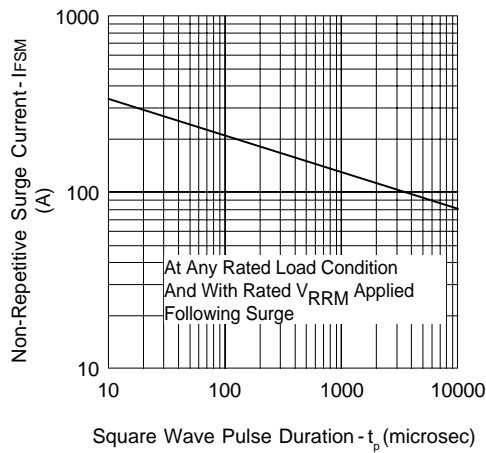

**Fig. 6 - Max. Non-Repetitive Surge Current**

(2) Formula used:  $T_C = T_J - (Pd + Pd_{REV}) \times R_{thJC}$ ;

$Pd = \text{Forward Power Loss} = I_{F(AV)} \times V_{FM} @ (I_{F(AV)} / D)$  (see Fig. 6);

$Pd_{REV} = \text{Inverse Power Loss} = V_{R1} \times I_R (1 - D)$ ;  $I_R @ V_{R1} = 80\%$  rated  $V_R$

Ordering Information Table

Device Code											
	<table border="1" style="margin: auto;"> <tr> <td style="padding: 5px;">31</td> <td style="padding: 5px;">D</td> <td style="padding: 5px;">Q</td> <td style="padding: 5px;">04</td> <td style="padding: 5px;">TR</td> </tr> <tr> <td style="text-align: center;">①</td> <td style="text-align: center;">②</td> <td style="text-align: center;">③</td> <td style="text-align: center;">④</td> <td style="text-align: center;">⑤</td> </tr> </table>	31	D	Q	04	TR	①	②	③	④	⑤
31	D	Q	04	TR							
①	②	③	④	⑤							
<b>1</b>	- 31 = 3.1A (Axial and small packages - Current is x10)										
<b>2</b>	- D = DO-41 package										
<b>3</b>	- Q = Schottky Q.. Series										
<b>4</b>	- 04 = Voltage Ratings										
<b>5</b>	- TR= Tape & Reel package (1200 pcs)										
	- = Box package (500 pcs)										

04 = 40V
03 = 30V

Data and specifications subject to change without notice.  
 This product has been designed and qualified for Industrial Level.  
 Qualification Standards can be found on IR's Web site.



LittleDiode supplies new, hard to find or obsolete electronic components and semiconductors all over the world.

With over two million different components listed you are sure to find the part you need.

Feel free to visit us today at our online store:

**[LittleDiode.com](http://LittleDiode.com)**

Looking forward to providing you with the best possible service.