

9601/DM9601 Retriggerable One Shot

General Description

These retriggerable one shots provide the designer with four inputs; two active high and two active low. This permits a choice of either leading-edge or trailing-edge triggering, independent of input transition times. When input conditions for triggering are met, a new cycle starts and the external capacitor is rapidly discharged and then allowed to charge again. The retriggerable feature allows for output pulse widths to be expanded. In fact a continuous true output can be maintained by having an input cycle time which is shorter than the output cycle time. Retriggering may be inhibited by tying the \bar{Q} output to an active low input.

Features

- High speed operation—input repetition rate > 10 MHz
- Flexibility of operation—optional retriggering/lock-out capability
- Output pulse width range—50 ns to ∞
- Leading or trailing edge triggering
- Complementary outputs/inputs
- Input clamping diodes
- DTL/TTL compatible logic levels
- Alternate Military/Aerospace device (9601) is available. Contact a National Semiconductor Sales Office/Distributor for specifications.

Connection Diagram

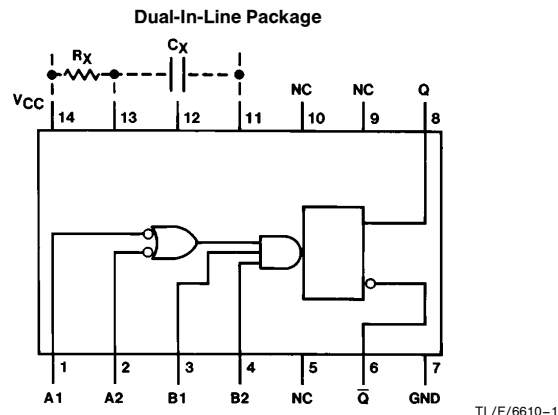

Order Number 9601DMQB, 9601FMQB, DM9601J, DM9601W or DM9601N
See NS Package Number J14A, N14A or W14B

Function Table

Inputs				Outputs	
A1	A2	B1	B2	Q	\bar{Q}
H	H	X	X	L	H
X	X	L	X	L	H
X	X	X	L	L	H
L	X	H	H	L	H
L	X	↑	H	⌊	⌋
L	X	H	↑	⌊	⌋
X	L	H	H	L	H
X	L	↑	H	⌊	⌋
X	L	H	↑	⌊	⌋
H	↓	H	H	⌊	⌋
↓	↓	H	H	⌊	⌋
↓	H	H	H	⌊	⌋

H = High Logic Level
L = Low Logic Level
X = Either Low or High Logic Level
↑ = Low to High Level Transition
↓ = High to Low Level Transition
⌊ = Positive Pulse
⌋ = Negative Pulse

Absolute Maximum Ratings (Note)

If Military/Aerospace specified devices are required, please contact the National Semiconductor Sales Office/Distributors for availability and specifications.

Supply Voltage	7V
Input Voltage	5.5V
Operating Free Air Temperature Range	
Military	−55°C to +125°C
Commercial	0° to +70°C
Storage Temperature Range	−65°C to +150°C

Note: The "Absolute Maximum Ratings" are those values beyond which the safety of the device cannot be guaranteed. The device should not be operated at these limits. The parametric values defined in the "Electrical Characteristics" table are not guaranteed at the absolute maximum ratings. The "Recommended Operating Conditions" table will define the conditions for actual device operation.

Recommended Operating Conditions

Symbol	Parameter	Military			Commercial			Units
		Min	Nom	Max	Min	Nom	Max	
V _{CC}	Supply Voltage	4.5	5	5.5	4.75	5	5.25	V
V _{IH}	High Level Input Voltage	T _A = −55°C	2					V
		T _A = 0°C				1.9		
		T _A = 25°C	1.7			1.8		
		T _A = 75°C				1.6		
		T _A = 125°C	1.5					
V _{IL}	Low Level Input Voltage	T _A = −55°C			0.85			V
		T _A = 0°C					0.85	
		T _A = 25°C			0.9		0.85	
		T _A = 75°C					0.85	
		T _A = 125°C			0.85			
I _{OH}	High Level Output Current			−0.72			−0.96	mA
I _{OL}	Low Level Output Current			10			12.8	mA
T _A	Free Air Operating Temperature	−55		125	0		75	°C

Electrical Characteristics over recommended operating free air temperature range (unless otherwise noted)

Symbol	Parameter	Conditions (Note 3)	Min	Typ (Note 1)	Max	Units
V _I	Input Clamp Voltage	V _{CC} = Min, I _I = −12 mA			−1.5	V
V _{OH}	High Level Output Voltage	V _{CC} = Min, I _{OH} = Max V _{IL} = Max, V _{IH} = Min, (Note 4)	2.4			V
V _{OL}	Low Level Output Voltage	V _{CC} = Min, I _{OL} = Max V _{IL} = Max, V _{IH} = Min (Note 4)	MIL		0.4	V
			COM		0.45	
I _{IH}	High Level Input Current	V _{CC} = Max, V _I = 4.5V			60	μA
I _{IL}	Low Level Input Current	V _{CC} = Max	MIL V _{IN} = 0.40V		−1.6	mA
			COM V _{IN} = 0.45V		−1.6	
I _{OS}	Short Circuit Output Current	V _{CC} = Max (Notes 2 and 4)	MIL	−10	−40	mA
			COM	−10	−40	
I _{CC}	Supply Current	V _{CC} = Max			25	mA

Note 1: All typicals are at V_{CC} = 5V, T_A = 25°C.

Note 2: Not more than one output should be shorted at a time.

Note 3: Unless otherwise noted, R_X = 10k between PIN 13 and V_{CC} on all tests.

Note 4: Ground PIN 11 for V_{OL} test on PIN 6, V_{OH} and I_{OS} tests on PIN 8. Open PIN 11 for V_{OL} test on PIN 8, V_{OH} and I_{OS} tests on PIN 6.

Switching Characteristics at $V_{CC} = 5V$ and $T_A = 25^\circ C$ (See Section 1 for Test Waveforms and Output Load)

Symbol	Parameter	From (Input) To (Output)	Conditions	Min	Max	Units
t_{PLH}	Propagation Delay Time Low to High Level Output	Negative Trigger Input to True Output	$C_L = 15 \text{ pF}$ $C_X = 0$ $R_X = 5 \text{ k}\Omega$		40	ns
t_{PHL}	Propagation Delay Time High to Low Level Output				40	ns
$t_{PW(MIN)}$	Minimum True Output Pulse Width				65	ns
t_{PW}	Pulse Width			$R_X = 10 \text{ k}\Omega$ $C_X = 1000 \text{ pF}$	3.08	3.76
C_{STRAY}	Maximum Allowable Wiring Capacitance		Pin 13 to GND		50	pF
R_X	External Timing Resistor		DM96		25	k Ω
R_X	External Timing Resistor		DM86		50	k Ω

Operating Rules

1. An external resistor R_X and an external capacitor C_X are required for operation. The value of R_X can vary between the limits shown in switching characteristics. The value of C_X is optional and may be adjusted to achieve the required output pulse width.

2. Output pulse width t_{PW} may be calculated as follows:

$$t_{PW} = K R_X C_X \left[1 + \frac{0.7}{R_X} \right] \quad (\text{for } C_X > 10^3 \text{ pF})$$

$K \approx 0.34$

R_X in k Ω , C_X in pF and t_{PW} in ns.

(For $C_X < 10^3$ pF, see curve.)

3. R_X and C_X must be kept as close as possible to the circuit in order to minimize stray capacitance and noise pickup. If remote trimming is required, R_X may be split up such that at least $R_{X(MIN)}$ must be as close as possible to the circuit and the remote portion of the trimming resistor $R < R_{X(MAX)} - R_X$.

4. Set-up time (t_1) for input trigger pulse must be > 40 ns. (See Figure 1).

Release time (t_2) for input trigger pulse must be > 40 ns. (See Figure 2).

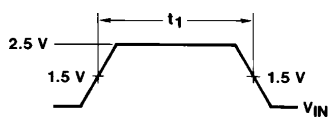

TL/F/6610-2

FIGURE 1

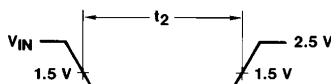

TL/F/6610-3

FIGURE 2

5. Retrigger pulse width (see Figure 3) is calculated as follows:

$$t_W = t_{PW} + t_{PLH} = K R_X C_X \left[1 + \frac{0.7}{R_X} \right] + t_{PLH}$$

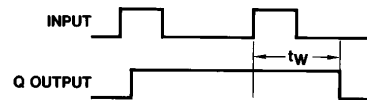

TL/F/6610-4

FIGURE 3

Typical "K" Coefficient Variation vs Timing Capacitance

The multiplicative factor "K" varies as a function of the timing capacitor, C_X . The graph below details this characteristic:

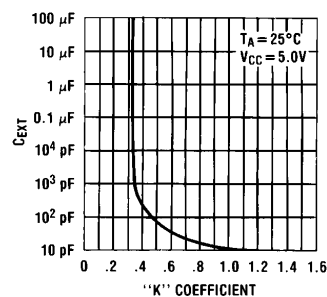

TL/F/6610-5

*For further detailed device characteristics and output performance, please refer to the NSC one-shot application note, AN-366.

Typical Performance Characteristics

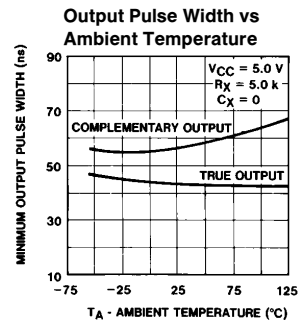
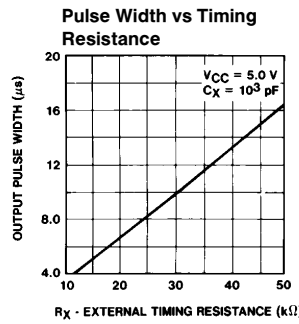
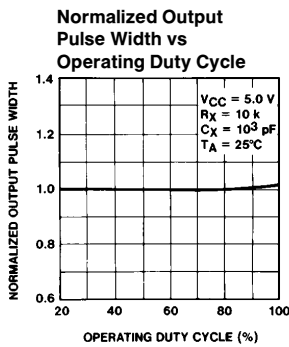
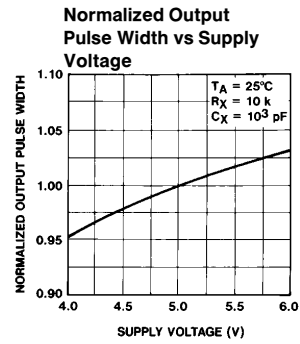
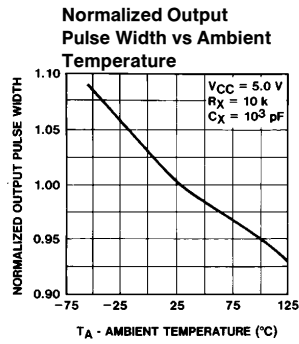
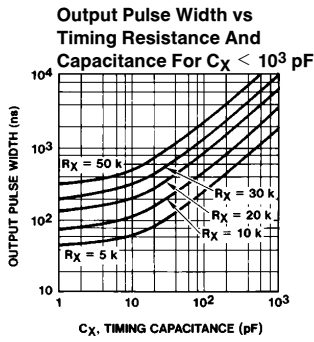

TL/F/6610-6

Schematic Diagram

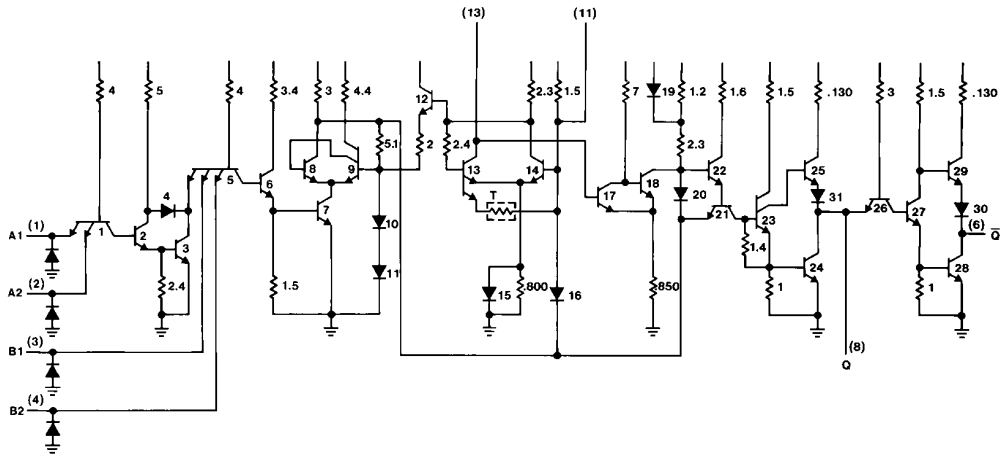

TL/F/6610-7

Physical Dimensions inches (millimeters)

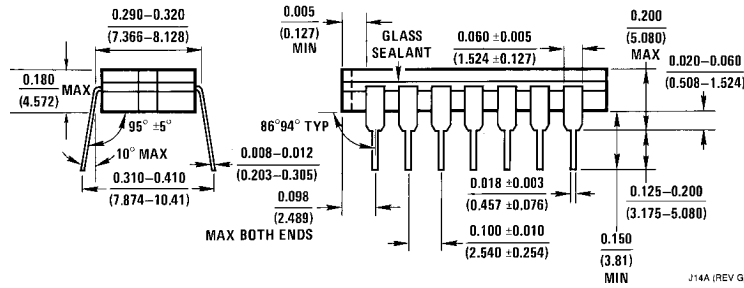
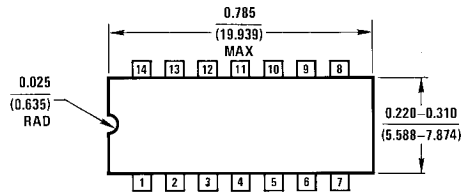

14-Lead Ceramic Dual-In-Line Package (J)
Order Number 9601DMQB or DM9601J
NS Package Number J14A

J14A (REV G)

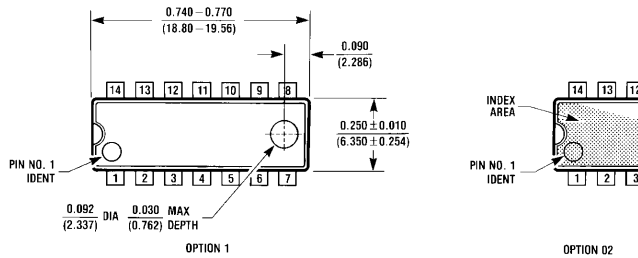

OPTION 1

OPTION 02

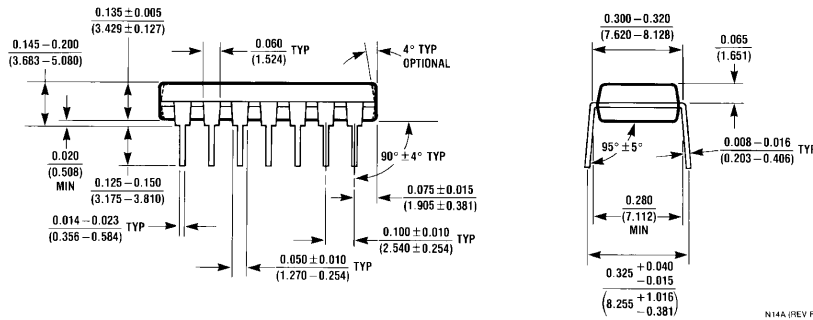

14-Lead Molded Dual-In-Line Package (N)
Order Number DM9601N
NS Package Number N14A

N14A (REV F)

Physical Dimensions inches (millimeters) (Continued)



14-Lead Ceramic Flat Package (W)
Order Number 9601FMQB or DM9601W
NS Package Number W14B

LIFE SUPPORT POLICY

NATIONAL'S PRODUCTS ARE NOT AUTHORIZED FOR USE AS CRITICAL COMPONENTS IN LIFE SUPPORT DEVICES OR SYSTEMS WITHOUT THE EXPRESS WRITTEN APPROVAL OF THE PRESIDENT OF NATIONAL SEMICONDUCTOR CORPORATION. As used herein:

1. Life support devices or systems are devices or systems which, (a) are intended for surgical implant into the body, or (b) support or sustain life, and whose failure to perform, when properly used in accordance with instructions for use provided in the labeling, can be reasonably expected to result in a significant injury to the user.
2. A critical component is any component of a life support device or system whose failure to perform can be reasonably expected to cause the failure of the life support device or system, or to affect its safety or effectiveness.



National Semiconductor Corporation
 1111 West Bardin Road
 Arlington, TX 76017
 Tel: 1(800) 272-9959
 Fax: 1(800) 737-7018

National Semiconductor Europe
 Fax: (+49) 0-180-530 85 86
 Email: cnjwge@tevm2.nsc.com
 Deutsch Tel: (+49) 0-180-530 85 85
 English Tel: (+49) 0-180-532 78 32
 Français Tel: (+49) 0-180-532 93 58
 Italiano Tel: (+49) 0-180-534 16 80

National Semiconductor Hong Kong Ltd.
 19th Floor, Straight Block,
 Ocean Centre, 5 Canton Rd.
 Tsimshatsui, Kowloon
 Hong Kong
 Tel: (852) 2737-1600
 Fax: (852) 2736-9960

National Semiconductor Japan Ltd.
 Tel: 81-043-299-2309
 Fax: 81-043-299-2408

National does not assume any responsibility for use of any circuitry described, no circuit patent licenses are implied and National reserves the right at any time without notice to change said circuitry and specifications.

This datasheet has been downloaded from:

www.DatasheetCatalog.com

Datasheets for electronic components.

National Semiconductor was acquired by Texas Instruments.

http://www.ti.com/corp/docs/investor_relations/pr_09_23_2011_national_semiconductor.html

This file is the datasheet for the following electronic components:

96L02DMQB - <http://www.ti.com/product/96l02dmb?HQS=TI-null-null-dscatalog-df-pf-null-ww>



LittleDiode supplies new, hard to find or obsolete electronic components and semiconductors all over the world.

With over two million different components listed you are sure to find the part you need.

Feel free to visit us today at our online store:

LittleDiode.com

Looking forward to providing you with the best possible service.