

# BCR12CM

MEDIUM POWER USE  
NON-INSULATED TYPE, PLANAR PASSIVATION TYPE

**BCR12CM**

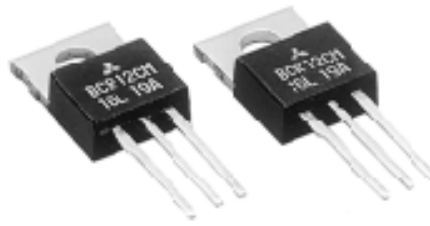

- $I_T$  (RMS) ..... 12A
- $V_{DRM}$  ..... 400V/600V
- $I_{FGT I}$ ,  $I_{RGT I}$ ,  $I_{RGT III}$  ..... 30mA (20mA) \*5

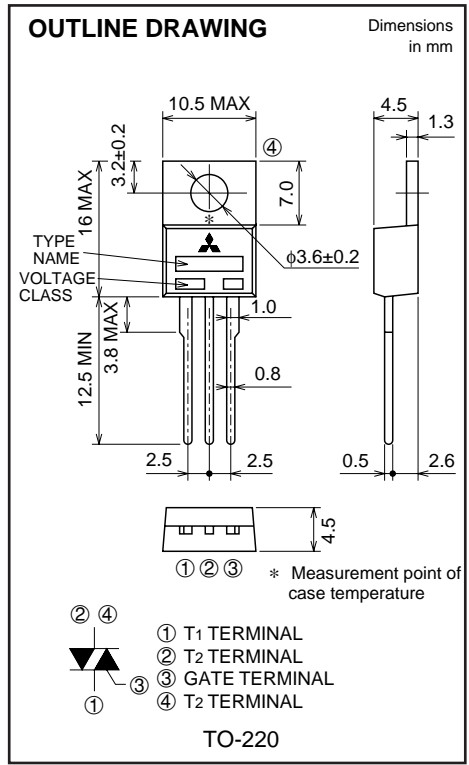

## APPLICATION

Contactless AC switches, light dimmer, electric flasher unit, control of household equipment such as TV sets · stereo · refrigerator · washing machine · infrared kotatsu · carpet · electric fan, solenoid drivers, small motor control, copying machine, electric tool, other general purpose control applications

## MAXIMUM RATINGS

Symbol	Parameter	Voltage class		Unit
		8	12	
$V_{DRM}$	Repetitive peak off-state voltage *1	400	600	V
$V_{DSM}$	Non-repetitive peak off-state voltage *1	500	720	V

Symbol	Parameter	Conditions	Ratings	Unit
$I_T$ (RMS)	RMS on-state current	Commercial frequency, sine full wave 360° conduction, $T_c=98^\circ\text{C}$	12	A
$I_{TSM}$	Surge on-state current	60Hz sinewave 1 full cycle, peak value, non-repetitive	120	A
$I_t^2$	$I_t^2$ for fusing	Value corresponding to 1 cycle of half wave 60Hz, surge on-state current	60	A <sup>2</sup> s
PGM	Peak gate power dissipation		5	W
PG (AV)	Average gate power dissipation		0.5	W
VGM	Peak gate voltage		10	V
IGM	Peak gate current		2	A
$T_j$	Junction temperature		-40 ~ +125	°C
$T_{stg}$	Storage temperature		-40 ~ +125	°C
—	Weight	Typical value	2.0	g

\*1. Gate open.

# BCR12CM

MEDIUM POWER USE

NON-INSULATED TYPE, PLANAR PASSIVATION TYPE

## ELECTRICAL CHARACTERISTICS

Symbol	Parameter	Test conditions	Limits			Unit	
			Min.	Typ.	Max.		
IDRM	Repetitive peak off-state current	T <sub>j</sub> =125°C, V <sub>DRM</sub> applied	—	—	2.0	mA	
V <sub>TM</sub>	On-state voltage	T <sub>c</sub> =25°C, I <sub>TM</sub> =20A, Instantaneous measurement	—	—	1.6	V	
V <sub>FGT I</sub>	Gate trigger voltage *2	T <sub>j</sub> =25°C, V <sub>D</sub> =6V, R <sub>L</sub> =6Ω, R <sub>G</sub> =330Ω	I	—	—	1.5	V
V <sub>RGT I</sub>			II	—	—	1.5	V
V <sub>RGT III</sub>			III	—	—	1.5	V
I <sub>FGT I</sub>	Gate trigger current *2	T <sub>j</sub> =25°C, V <sub>D</sub> =6V, R <sub>L</sub> =6Ω, R <sub>G</sub> =330Ω	I	—	—	30*5	mA
I <sub>RGT I</sub>			II	—	—	30*5	mA
I <sub>RGT III</sub>			III	—	—	30*5	mA
V <sub>GD</sub>	Gate non-trigger voltage	T <sub>j</sub> =125°C, V <sub>D</sub> =1/2V <sub>DRM</sub>	0.2	—	—	V	
R <sub>th(j-c)</sub>	Thermal resistance	Junction to case *4	—	—	1.8	°C/W	
(dv/dt) <sub>c</sub>	Critical-rate of rise of off-state commutating voltage		*3	—	—	V/μs	

- \*2. Measurement using the gate trigger characteristics measurement circuit.
- \*3. The critical-rate of rise of the off-state commutating voltage is shown in the table below.
- \*4. The contact thermal resistance R<sub>th(c-f)</sub> in case of greasing is 1.0°C/W.
- \*5. High sensitivity (I<sub>GT</sub>≤20mA) is also available. (IGT item ①)

Voltage class	V <sub>DRM</sub> (V)	(dv/dt) <sub>c</sub>			Test conditions	Commutating voltage and current waveforms (inductive load)
		Symbol	Min.	Unit		
8	400	R	—	V/μs	1. Junction temperature T <sub>j</sub> =125°C 2. Rate of decay of on-state commutating current (di/dt) <sub>c</sub> =-6A/ms 3. Peak off-state voltage V <sub>D</sub> =400V	
		L	10			
12	600	R	—			
		L	10			

## PERFORMANCE CURVES

MAXIMUM ON-STATE CHARACTERISTICS

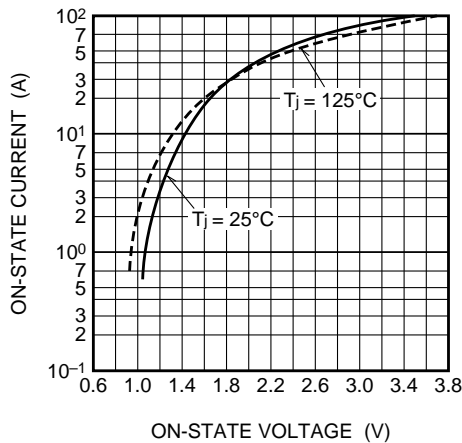

RATED SURGE ON-STATE CURRENT

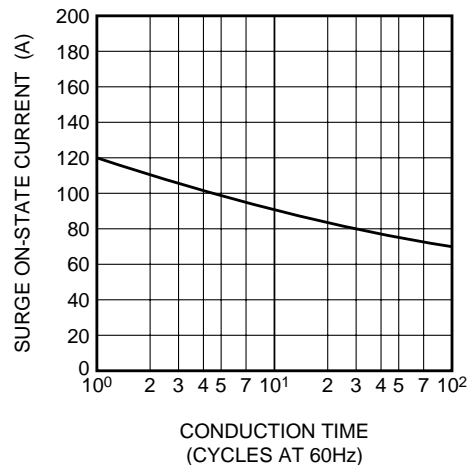

# BCR12CM

MEDIUM POWER USE

NON-INSULATED TYPE, PLANAR PASSIVATION TYPE

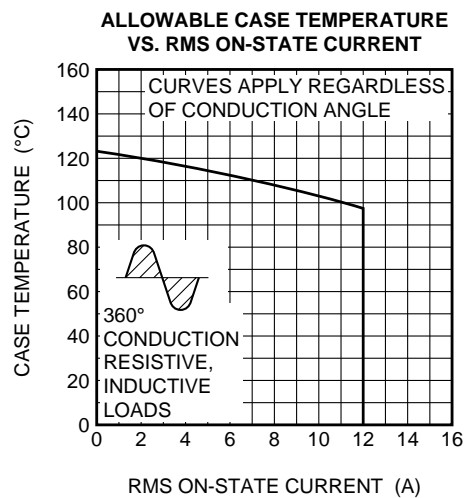
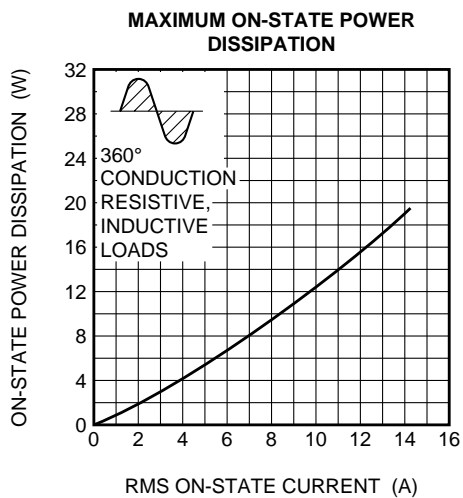
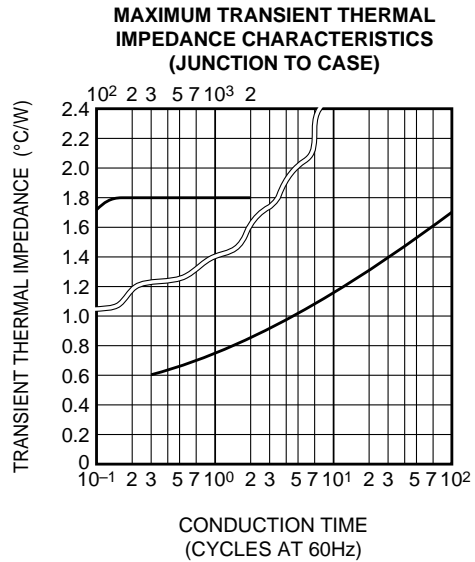
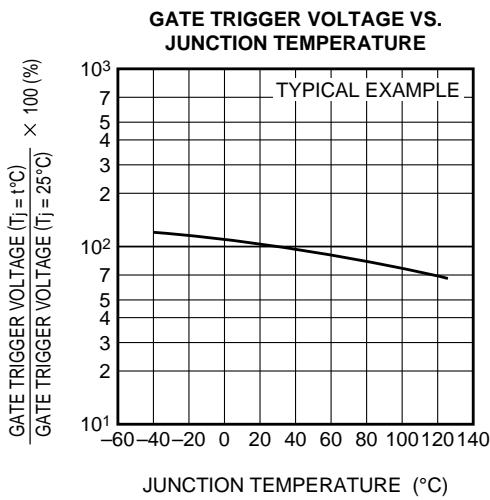
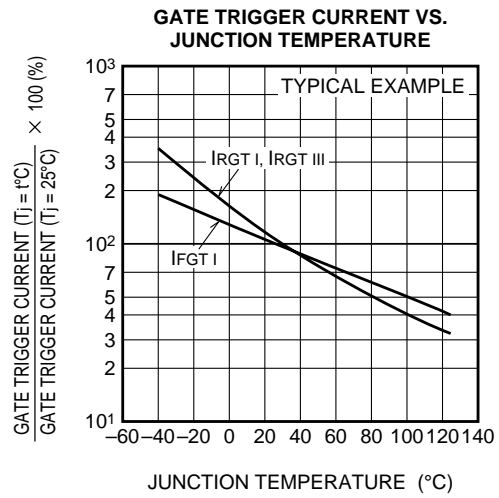
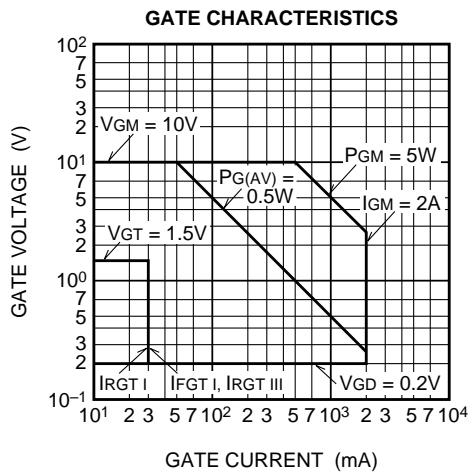

# BCR12CM

MEDIUM POWER USE

NON-INSULATED TYPE, PLANAR PASSIVATION TYPE

**ALLOWABLE AMBIENT TEMPERATURE VS. RMS ON-STATE CURRENT**

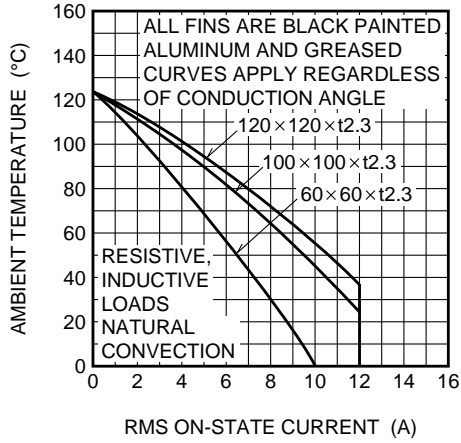

**ALLOWABLE AMBIENT TEMPERATURE VS. RMS ON-STATE CURRENT**

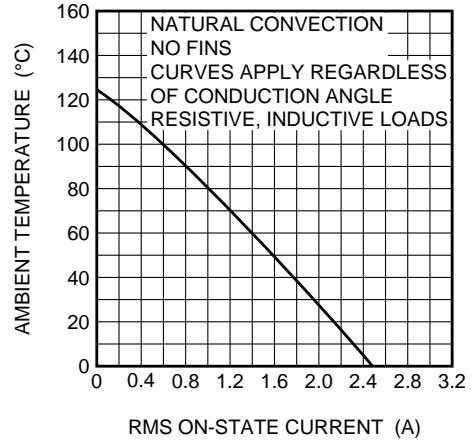

**REPETITIVE PEAK OFF-STATE CURRENT VS. JUNCTION TEMPERATURE**

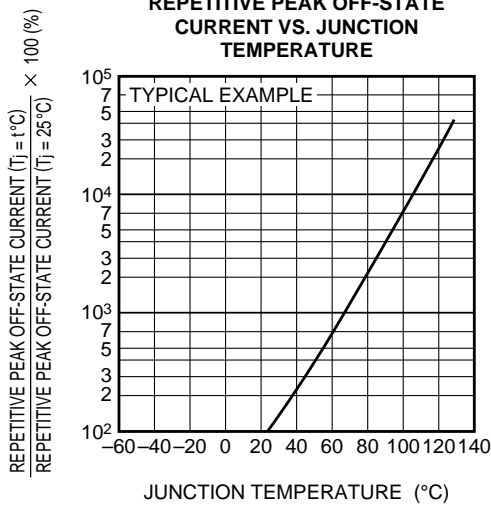

**HOLDING CURRENT VS. JUNCTION TEMPERATURE**

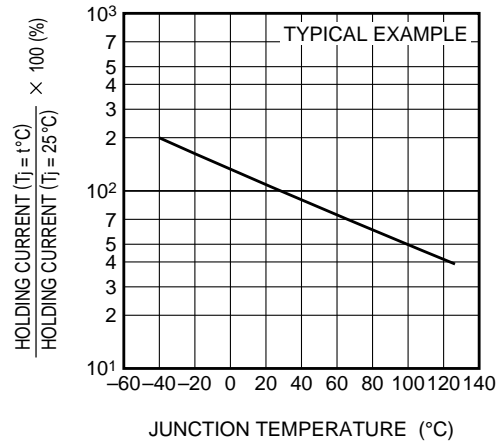

**LATCHING CURRENT VS. JUNCTION TEMPERATURE**

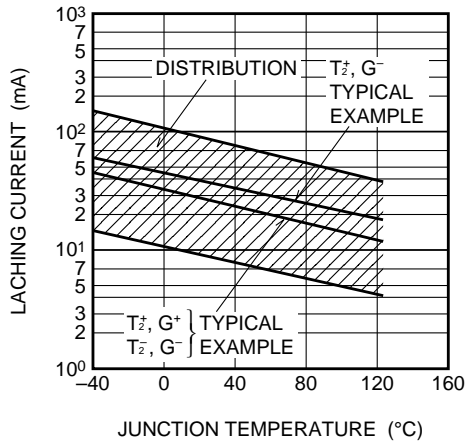

**BREAKOVER VOLTAGE VS. JUNCTION TEMPERATURE**

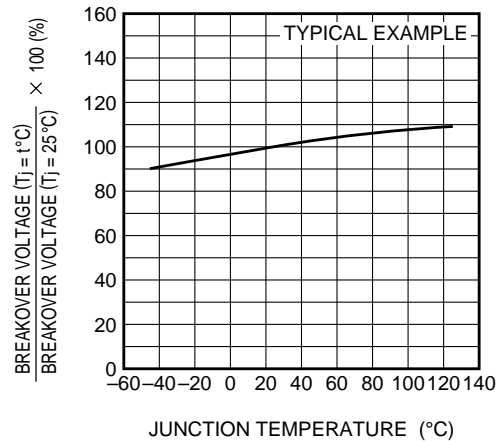

# BCR12CM

MEDIUM POWER USE

NON-INSULATED TYPE, PLANAR PASSIVATION TYPE

**BREAKOVER VOLTAGE VS. RATE OF RISE OF OFF-STATE VOLTAGE**

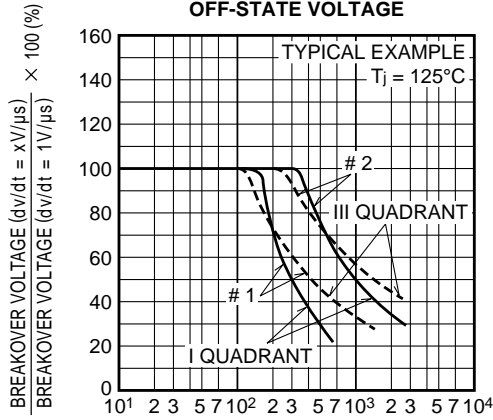

RATE OF RISE OF OFF-STATE VOLTAGE (V/μs)

**COMMUTATION CHARACTERISTICS**

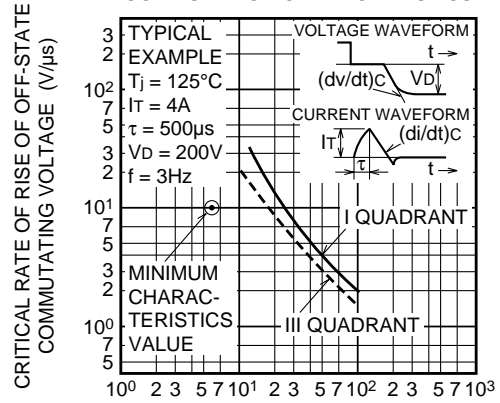

RATE OF DECAY OF ON-STATE COMMUTATING CURRENT (A/ms)

**GATE TRIGGER CURRENT VS. GATE CURRENT PULSE WIDTH**

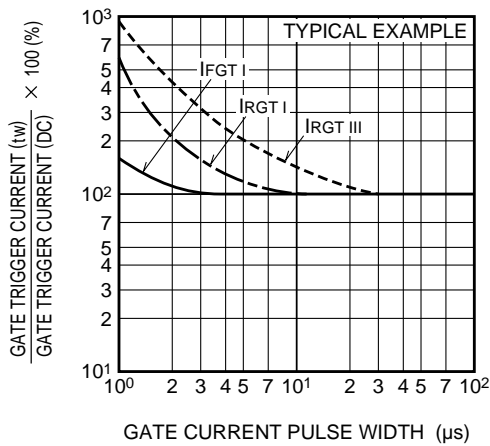

GATE CURRENT PULSE WIDTH (μs)

**GATE TRIGGER CHARACTERISTICS TEST CIRCUITS**

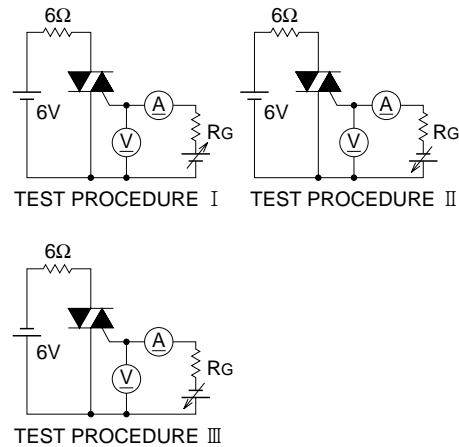

This datasheet has been downloaded from:

[www.DatasheetCatalog.com](http://www.DatasheetCatalog.com)

Datasheets for electronic components.



LittleDiode supplies new, hard to find or obsolete electronic components and semiconductors all over the world.

With over two million different components listed you are sure to find the part you need.

Feel free to visit us today at our online store:

[LittleDiode.com](http://LittleDiode.com)

Looking forward to providing you with the best possible service.