

### Features

- On-state rms current: 30 A
- Blocking voltage: up to 1200 V
- Gate current: 50 mA
- UL 2500 V insulation (file ref E81734)

### Description

Available in a high power insulated package, the BTW68 series is suitable for applications where power handling and power dissipation are critical such as solid state relays, welding equipment and high power motor control.

Based on a clip assembly technology, this device offers a superior performance in surge current handling capabilities.

Thanks to the internal ceramic pad, the device provides high voltage insulation (2500 V<sub>RMS</sub>) and complies with UL standards (file ref: E81734).

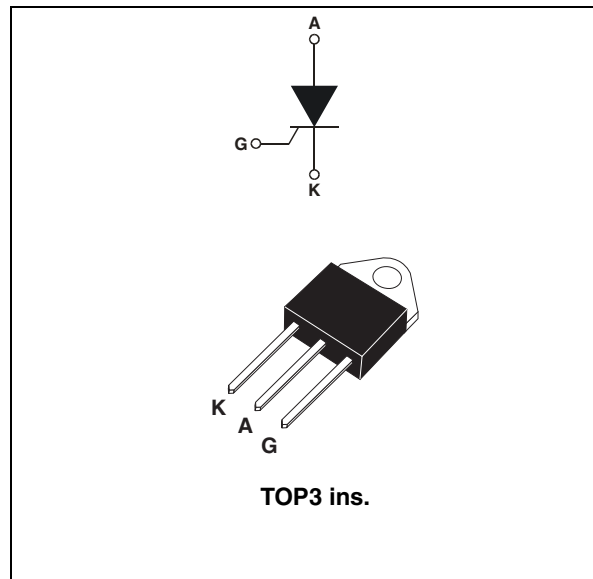

**Table 1. Device summary**

Symbol	Value
$I_{T(RMS)}$	30 A
$V_{DRM}/V_{RRM}$	600 to 1200 V
$I_{GT}$	50 mA

# 1 Characteristics

**Table 2. Absolute maximum ratings (limiting values)**

Symbol	Parameter		Value	Unit	
$I_{T(RMS)}$	On-state current rms (180° conduction angle)		$T_c = 80\text{ °C}$	30	A
$I_{T(AV)}$	Average on-state current (180° conduction angle)		$T_c = 80\text{ °C}$	19	A
$I_{TSM}$	Non repetitive surge peak on-state current	$t_p = 8.3\text{ ms}$	$T_j = 25\text{ °C}$	420	A
		$t_p = 10\text{ ms}$		400	
$I^2t$	$I^2t$ Value for fusing		$T_j = 25\text{ °C}$	800	A <sup>2</sup> s
$di/dt$	Critical rate of rise of on-state current $I_G = 2 \times I_{GT}, t_r \leq 100\text{ ns}$	$F = 60\text{ Hz}$	$T_j = 125\text{ °C}$	100	A/ $\mu$ s
$I_{GM}$	Peak gate current	$t_p = 20\text{ }\mu$ s	$T_j = 125\text{ °C}$	8	A
$P_{G(AV)}$	Average gate power dissipation		$T_j = 125\text{ °C}$	1	W
$T_{stg}$ $T_j$	Storage junction temperature range Operating junction temperature range			- 40 to + 150 - 40 to + 125	°C
$V_{RGM}$	Maximum peak reverse gate voltage			5	V

**Table 3. Electrical characteristics ( $T_j = 25\text{ °C}$ , unless otherwise specified)**

Symbol	Test conditions		Value	Unit		
$I_{GT}$	$V_D = 12\text{ V}, R_L = 33\text{ }\Omega$	MIN.	50	mA		
$V_{GT}$		MAX.	1.5	V		
$V_{GD}$	$V_D = V_{DRM}, R_L = 3.3\text{ k}\Omega$	$T_j = 125\text{ °C}$	MIN.	0.2	V	
$t_{gt}$	$V_D = V_{DRM}, I_G = 200\text{ mA}, di_G/dt = 1.5\text{ A}/\mu$ s		TYP.	2	$\mu$ s	
$I_H$	$I_T = 500\text{ mA}$ , gate open		MAX.	75	mA	
$I_L$	$I_G = 1.2 \times I_{GT}$		TYP.	40	mA	
$dV/dt$	$V_D = 67\% V_{DRM}$ gate open	$V_{DRM} = 800\text{ V}$ $V_{DRM} = 1000\text{ V}$	$T_j = 125\text{ °C}$	MIN.	500	V/ $\mu$ s
					250	
$V_{TM}$	$I_{TM} = 60\text{ A}, t_p = 380\text{ }\mu$ s		MAX.	2.1	V	
$I_{DRM}$ $I_{RRM}$	$V_{DRM} = V_{RRM}$		$T_j = 25\text{ °C}$	MAX.	20	$\mu$ A
			$T_j = 125\text{ °C}$		6	mA
$t_q$	$V_D = 67\% V_{DRM}, I_{TM} = 60\text{ A}, V_R = 75\text{ V}$ $dI_{TM}/dt = 30\text{ A}/\mu$ s, $dV_D/dt = 20\text{ V}/\mu$ s		$T_j = 125\text{ °C}$	TYP.	100	$\mu$ s

**Table 4. Thermal resistance**

Symbol	Parameter	Value	Unit
$R_{th(j-c)}$	Junction to case (D.C.)	1.1	°C/W
$R_{th(j-a)}$	Junction to ambient	50	°C/W

**Figure 1. Maximum average power dissipation versus average on-state current**

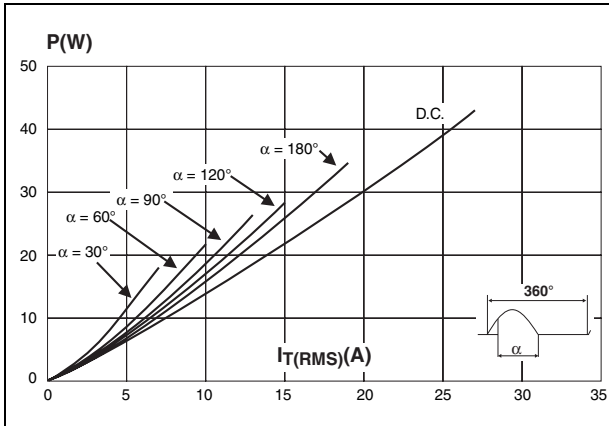

**Figure 2. Correlation between maximum average power dissipation and maximum allowable temperature**

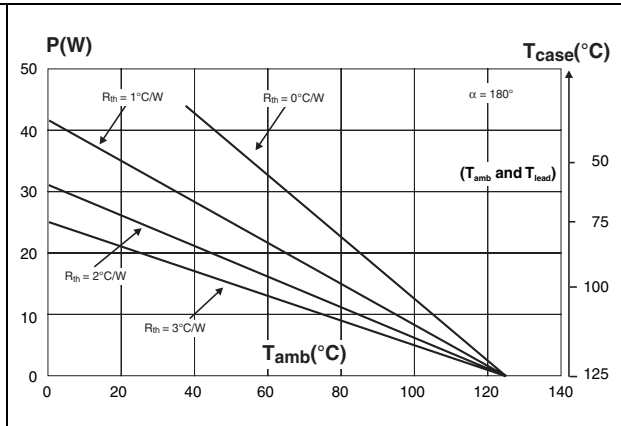

**Figure 3. Average on-state current versus case temperature**

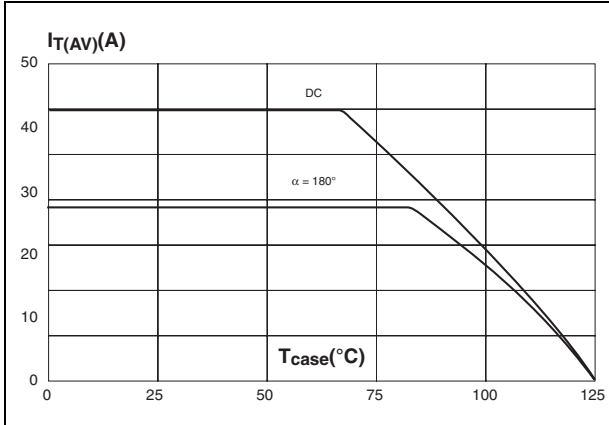

**Figure 4. Relative variation of thermal impedance versus pulse duration**

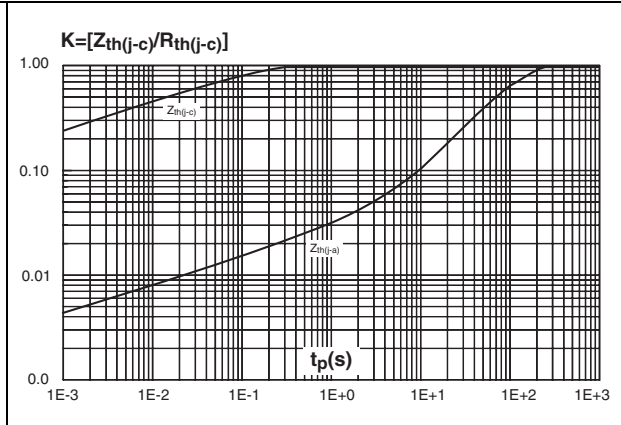

**Figure 5. Relative variation of gate trigger current versus junction temperature**

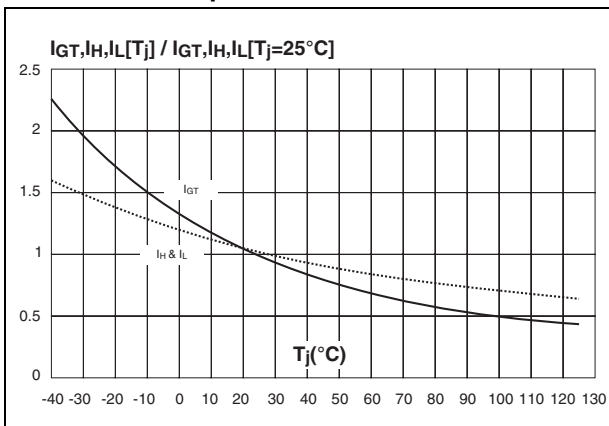

**Figure 6. Surge peak on-state current versus number of cycles**

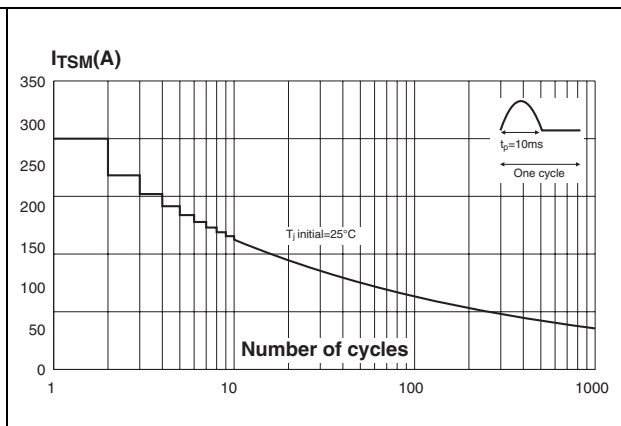

**Figure 7. Non repetitive surge peak on-state current and corresponding value of  $I^2t$  versus sinusoidal pulse width**

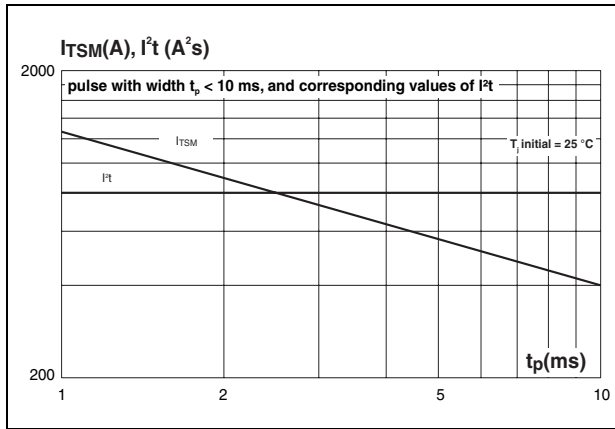

**Figure 8. On-state characteristics (maximum values)**

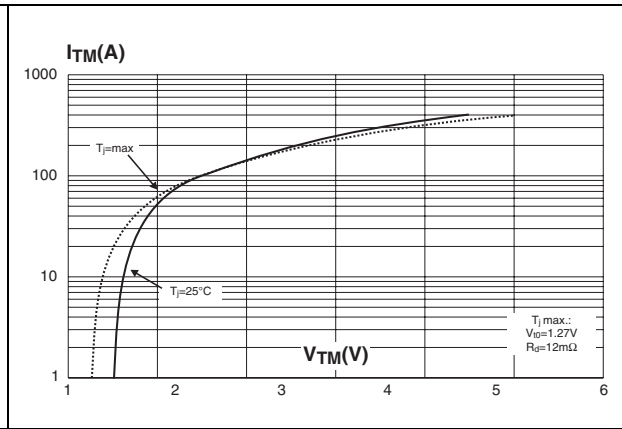

## 2 Ordering information scheme

Figure 9. Ordering information scheme

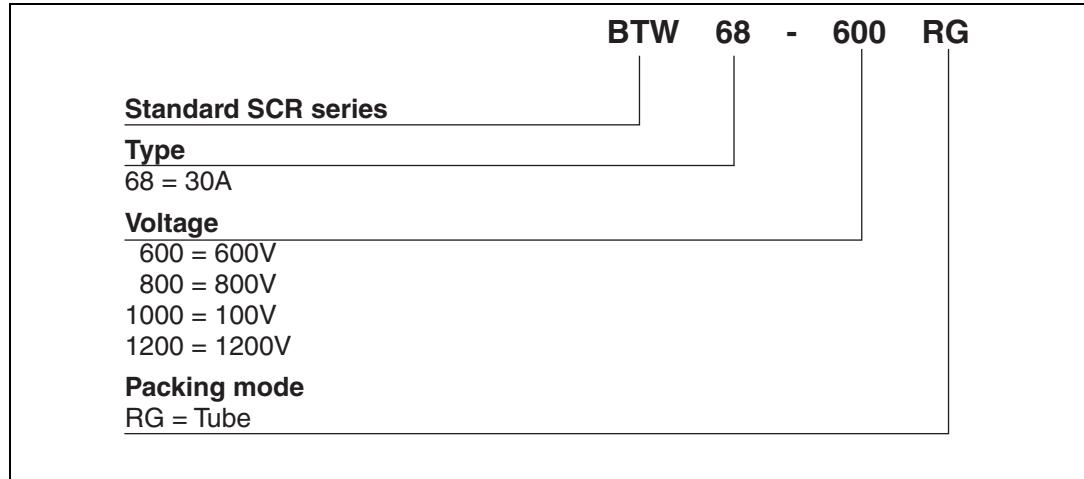

Table 5. Product Selector

Part numbers	Voltage (xxx)				Sensitivity	Package
	600 V	800 V	1000 V	1200 V		
BTW68-600RG	X				50 mA	TOP3 Ins.
BTW68-800RG		X				
BTW68-1000RG			X			
BTW68-1200RG				X		

### 3 Package information

- Epoxy meets UL94,V0
- Lead-free packages

In order to meet environmental requirements, ST offers these devices in different grades of ECOPACK® packages, depending on their level of environmental compliance. ECOPACK® specifications, grade definitions and product status are available at: [www.st.com](http://www.st.com). ECOPACK® is an ST trademark.

**Table 6. TOP3 ins. dimensions**

Ref.	Dimensions			
	Millimeters		Inches	
	Min.	Max.	Min.	Max.
A	4.4	4.6	0.173	0.181
B	1.45	1.55	0.057	0.061
C	14.35	15.60	0.565	0.614
D	0.5	0.7	0.020	0.028
E	2.7	2.9	0.106	0.114
F	15.8	16.5	0.622	0.650
G	20.4	21.1	0.815	0.831
H	15.1	15.5	0.594	0.610
J	5.4	5.65	0.213	0.222
K	3.4	3.65	0.134	0.144
ØL	4.08	4.17	0.161	0.164
P	1.20	1.40	0.047	0.055
R	4.60 typ.		0.181 typ.	

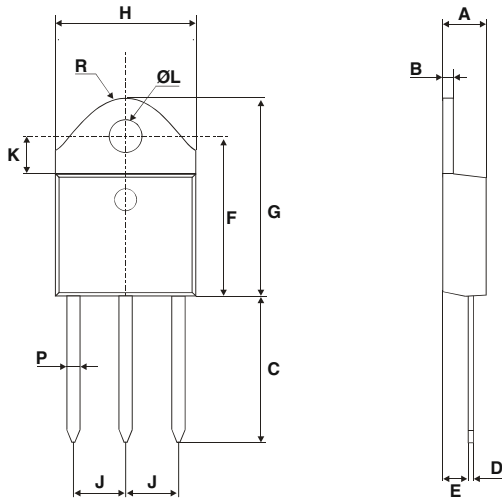

## 4 Ordering information

**Table 7. Ordering information**

Order code	Marking	Package	Weight	Base qty	Delivery mode
BTW68-600RG	BTW68-600	TOP3 ins.	4.5 g	30	Tube
BTW68-800RG	BTW68-800				
BTW68-1000RG	BTW68-1000				
BTW68-1200RG	BTW68-1200				

## 5 Revision history

**Table 8. Document revision history**

Date	Revision	Changes
Mar-1995	1	Initial release.
13-Feb-2006	2	TOP3 Insulated delivery mode changed from bulk to tube. ECOPACK statement added.
29-Jul-2010	3	Deleted part number BTW68-200RG. Updated <a href="#">Table 2</a> , <a href="#">Figure 7</a> and alpha angle in <a href="#">Figure 1</a> .

**Please Read Carefully:**

Information in this document is provided solely in connection with ST products. STMicroelectronics NV and its subsidiaries ("ST") reserve the right to make changes, corrections, modifications or improvements, to this document, and the products and services described herein at any time, without notice.

All ST products are sold pursuant to ST's terms and conditions of sale.

Purchasers are solely responsible for the choice, selection and use of the ST products and services described herein, and ST assumes no liability whatsoever relating to the choice, selection or use of the ST products and services described herein.

No license, express or implied, by estoppel or otherwise, to any intellectual property rights is granted under this document. If any part of this document refers to any third party products or services it shall not be deemed a license grant by ST for the use of such third party products or services, or any intellectual property contained therein or considered as a warranty covering the use in any manner whatsoever of such third party products or services or any intellectual property contained therein.

**UNLESS OTHERWISE SET FORTH IN ST'S TERMS AND CONDITIONS OF SALE ST DISCLAIMS ANY EXPRESS OR IMPLIED WARRANTY WITH RESPECT TO THE USE AND/OR SALE OF ST PRODUCTS INCLUDING WITHOUT LIMITATION IMPLIED WARRANTIES OF MERCHANTABILITY, FITNESS FOR A PARTICULAR PURPOSE (AND THEIR EQUIVALENTS UNDER THE LAWS OF ANY JURISDICTION), OR INFRINGEMENT OF ANY PATENT, COPYRIGHT OR OTHER INTELLECTUAL PROPERTY RIGHT.**

**UNLESS EXPRESSLY APPROVED IN WRITING BY AN AUTHORIZED ST REPRESENTATIVE, ST PRODUCTS ARE NOT RECOMMENDED, AUTHORIZED OR WARRANTED FOR USE IN MILITARY, AIR CRAFT, SPACE, LIFE SAVING, OR LIFE SUSTAINING APPLICATIONS, NOR IN PRODUCTS OR SYSTEMS WHERE FAILURE OR MALFUNCTION MAY RESULT IN PERSONAL INJURY, DEATH, OR SEVERE PROPERTY OR ENVIRONMENTAL DAMAGE. ST PRODUCTS WHICH ARE NOT SPECIFIED AS "AUTOMOTIVE GRADE" MAY ONLY BE USED IN AUTOMOTIVE APPLICATIONS AT USER'S OWN RISK.**

Resale of ST products with provisions different from the statements and/or technical features set forth in this document shall immediately void any warranty granted by ST for the ST product or service described herein and shall not create or extend in any manner whatsoever, any liability of ST.

ST and the ST logo are trademarks or registered trademarks of ST in various countries.

Information in this document supersedes and replaces all information previously supplied.

The ST logo is a registered trademark of STMicroelectronics. All other names are the property of their respective owners.

© 2010 STMicroelectronics - All rights reserved

STMicroelectronics group of companies

Australia - Belgium - Brazil - Canada - China - Czech Republic - Finland - France - Germany - Hong Kong - India - Israel - Italy - Japan - Malaysia - Malta - Morocco - Philippines - Singapore - Spain - Sweden - Switzerland - United Kingdom - United States of America

[www.st.com](http://www.st.com)



LittleDiode supplies new, hard to find or obsolete electronic components and semiconductors all over the world.

With over two million different components listed you are sure to find the part you need.

Feel free to visit us today at our online store:

[LittleDiode.com](http://LittleDiode.com)

Looking forward to providing you with the best possible service.