

# KA224/KA224A, KA324/KA324A, KA2902

## Quad Operational Amplifier

### Features

- Internally Frequency Compensated for Unity Gain
- Large DC Voltage Gain: 100dB
- Wide Power Supply Range:  
KA224 / KA224A, KA324 / KA324A : 3V~32V (or  $\pm 1.5$  ~ 16V)  
KA2902: 3V~26V (or  $\pm 1.5$ V ~ 13V)
- Input Common Mode Voltage Range Includes Ground
- Large Output Voltage Swing: 0V to  $V_{CC} - 1.5$ V
- Power Drain Suitable for Battery Operation

### Description

The KA324 series consist of four independent, high gain, internally frequency compensated operational amplifiers which were designed specifically to operate from a single power supply over a wide voltage range. Operation from split power supplies is also possible so long as the difference between the two supplies is 3 volts to 32 volts. Application areas include transducer amplifier, DC gain blocks and all the conventional OP Amp circuits which now can be easily implemented in single power supply systems.



### Internal Block Diagram

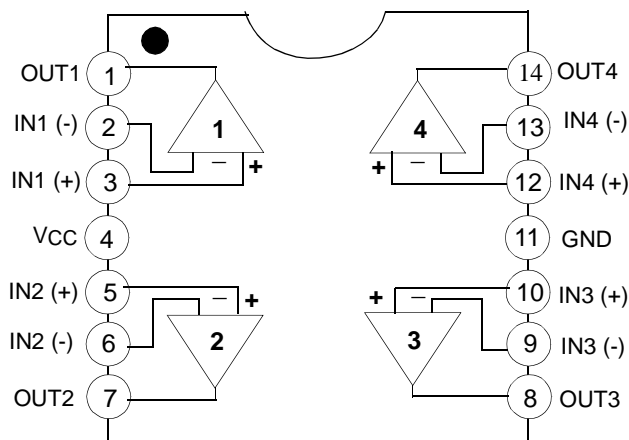

## Schematic Diagram

(One Section Only)

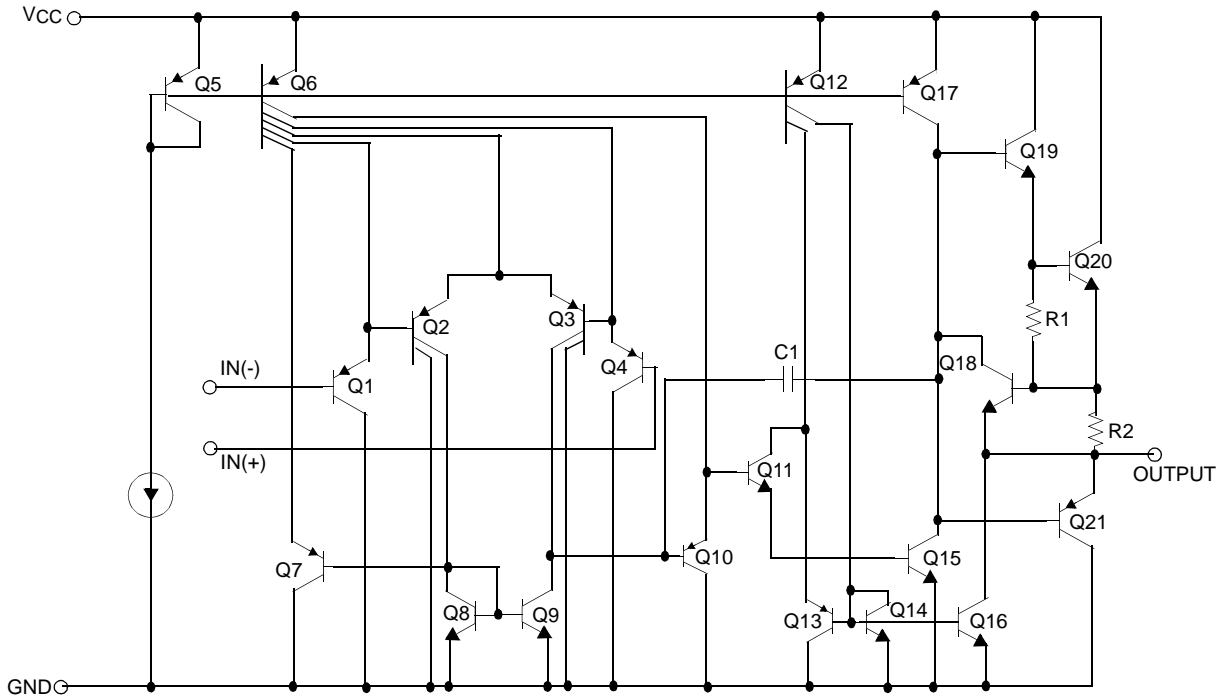

## Absolute Maximum Ratings

Parameter	Symbol	KA224/KA224A	KA324/KA324A	KA2902	Unit
Power Supply Voltage	VCC	±16 or 32	±16 or 32	±13 or 26	V
Differential Input Voltage	V <sub>I(DIFF)</sub>	32	32	26	V
Input Voltage	V <sub>I</sub>	-0.3 to +32	-0.3 to +32	-0.3 to +26	V
Output Short Circuit to GND V <sub>CC</sub> ≤ 15V, T <sub>A</sub> = 25°C (One Amp)	-	Continuous	Continuous	Continuous	-
Power Dissipation, T <sub>A</sub> = 25°C 14-DIP 14-SOP	P <sub>D</sub>	1310 640	1310 640	1310 640	mW
Operating Temperature Range	T <sub>OPR</sub>	-25 ~ +85	0 ~ +70	-40 ~ +85	°C
Storage Temperature Range	T <sub>STG</sub>	-65 ~ +150	-65 ~ +150	-65 ~ +150	°C

## Thermal Data

Parameter	Symbol	Value	Unit
Thermal Resistance Junction-Ambient Max. 14-DIP 14-SOP	R <sub>θja</sub>	95 195	°C/W

## Electrical Characteristics

(VCC = 5.0V, VEE = GND, TA = 25°C, unless otherwise specified)

Parameter	Symbol	Conditions	KA224			KA324			KA2902			Unit	
			Min.	Typ.	Max.	Min.	Typ.	Max.	Min.	Typ.	Max.		
Input Offset Voltage	V <sub>IO</sub>	V <sub>CM</sub> =0V to V <sub>CC</sub> -1.5V V <sub>O(P)</sub> = 1.4V, R <sub>S</sub> = 0Ω (Note1)	-	1.5	5.0	-	1.5	7.0	-	1.5	7.0	mV	
Input Offset Current	I <sub>IO</sub>	V <sub>CM</sub> =0V	-	2.0	30	-	3.0	50	-	3.0	50	nA	
Input Bias Current	I <sub>BIAS</sub>	V <sub>CM</sub> =0V	-	40	150	-	40	250	-	40	250	nA	
Input Common Mode Voltage Range	V <sub>I(R)</sub>	Note1	0	-	V <sub>CC</sub> -1.5	0	V <sub>CC</sub> -1.5	-	0	-	V <sub>CC</sub> -1.5	V	
Supply Current	I <sub>CC</sub>	R <sub>L</sub> = ∞, V <sub>CC</sub> = 30V (KA2902, V <sub>CC</sub> =26V)	-	1.0	3	-	1.0	3	-	1.0	3	mA	
		R <sub>L</sub> = ∞, V <sub>CC</sub> = 5V	-	0.7	1.2	-	0.7	1.2	-	0.7	1.2	mA	
Large Signal Voltage Gain	G <sub>V</sub>	V <sub>CC</sub> = 15V, R <sub>L</sub> =2kΩ V <sub>O(P)</sub> = 1V to 11V	50	100	-	25	100	-	25	100	-	V/mV	
Output Voltage Swing	V <sub>O(H)</sub>	Note1	R <sub>L</sub> = 2kΩ	26	-	-	26	-	-	22	-	-	V
			R <sub>L</sub> = 10kΩ	27	28	-	27	28	-	23	24	-	V
	V <sub>O(L)</sub>	V <sub>CC</sub> = 5V, R <sub>L</sub> =10kΩ	-	5	20	-	5	20	-	5	100	mV	
Common-Mode Rejection Ratio	CMRR	-	70	85	-	65	75	-	50	75	-	dB	
Power Supply Rejection Ratio	PSRR	-	65	100	-	65	100	-	50	100	-	dB	
Channel Separation	CS	f = 1kHz to 20kHz (Note2)	-	120	-	-	120	-	-	120	-	dB	
Short Circuit to GND	I <sub>SC</sub>	V <sub>CC</sub> = 15V	-	40	60	-	40	60	-	40	60	mA	
Output Current	I <sub>SOURCE</sub>	V <sub>I(+)</sub> = 1V, V <sub>I(-)</sub> = 0V V <sub>CC</sub> = 15V, V <sub>O(P)</sub> = 2V	20	40	-	20	40	-	20	40	-	mA	
	I <sub>SINK</sub>	V <sub>I(+)</sub> = 0V, V <sub>I(-)</sub> = 1V V <sub>CC</sub> = 15V V <sub>O(P)</sub> = 2V	10	13	-	10	13	-	10	13	-	mA	
		V <sub>I(+)</sub> = 0V, V <sub>I(-)</sub> = 1V V <sub>CC</sub> = 5V V <sub>O(R)</sub> = 200mV	12	45	-	12	45	-	-	-	-	μA	
Differential Input Voltage	V <sub>I(DIFF)</sub>	-	-	-	V <sub>CC</sub>	-	-	V <sub>CC</sub>	-	-	V <sub>CC</sub>	V	

### Note:

- V<sub>CC</sub>=30V for KA224 / KA224A , KA324 / KA324A , V<sub>CC</sub> = 26V for KA2902
- This parameter, although guaranteed, is not 100% tested in production.

**Electrical Characteristics** (Continued)

(VCC = 5.0V, VEE = GND, unless otherwise specified)

The following specification apply over the range of  $-25^{\circ}\text{C} \leq T_A \leq +85^{\circ}\text{C}$  for the KA224; and the  $0^{\circ}\text{C} \leq T_A \leq +70^{\circ}\text{C}$  for the KA324 ; and the  $-40^{\circ}\text{C} \leq T_A \leq +85^{\circ}\text{C}$  for the KA2902

Parameter	Symbol	Conditions	KA224			KA324			KA2902			Unit	
			Min.	Typ.	Max.	Min.	Typ.	Max.	Min.	Typ.	Max.		
Input Offset Voltage	$V_{IO}$	$V_{ICM} = 0V$ to $V_{CC} - 1.5V$ $V_{O(P)} = 1.4V$ , $R_S = 0\Omega$ (Note1)	-	-	7.0	-	-	9.0	-	-	10.0	mV	
Input Offset Voltage Drift	$\Delta V_{IO}/\Delta T$	$R_S = 0\Omega$ (Note2)	-	7.0	-	-	7.0	-	-	7.0	-	$\mu\text{V}/^{\circ}\text{C}$	
Input Offset Current	$I_{IO}$	$V_{CM} = 0V$	-	-	100	-	-	150	-	-	200	nA	
Input Offset Current Drift	$\Delta I_{IO}/\Delta T$	$R_S = 0\Omega$ (Note2)	-	10	-	-	10	-	-	10	-	$\text{pA}/^{\circ}\text{C}$	
Input Bias Current	$I_{BIAS}$	$V_{CM} = 0V$	-	-	300	-	-	500	-	-	500	nA	
Input Common Mode Voltage Range	$V_{I(R)}$	Note1	0	-	$V_{CC} - 2.0$	0	-	$V_{CC} - 2.0$	0	-	$V_{CC} - 2.0$	V	
Large Signal Voltage Gain	$G_V$	$V_{CC} = 15V$ , $R_L = 2.0k\Omega$ $V_{O(P)} = 1V$ to $11V$	25	-	-	15	-	-	15	-	-	V/mV	
Output Voltage Swing	$V_{O(H)}$	Note1	$R_L = 2k\Omega$	26	-	-	26	-	-	22	-	-	V
			$R_L = 10k\Omega$	27	28	-	27	28	-	23	24	-	V
	$V_{O(L)}$	$V_{CC} = 5V$ , $R_L = 10k\Omega$	-	5	20	-	5	20	-	5	100	mV	
Output Current	$I_{SOURCE}$	$V_{I(+)} = 1V$ , $V_{I(-)} = 0V$ $V_{CC} = 15V$ , $V_{O(P)} = 2V$	10	20	-	10	20	-	10	20	-	mA	
	$I_{SINK}$	$V_{I(+)} = 0V$ , $V_{I(-)} = 1V$ $V_{CC} = 15V$ , $V_{O(P)} = 2V$	10	13	-	5	8	-	5	8	-	mA	
Differential Input Voltage	$V_{I(DIFF)}$	-	-	-	$V_{CC}$	-	-	$V_{CC}$	-	-	$V_{CC}$	V	

**Note:**

1.  $V_{CC} = 30V$  for KA224/KA224A , KA324/KA324A ,  $V_{CC} = 26V$  for KA2902
2. These parameters, although guaranteed, are not 100% tested in production.

**Electrical Characteristics** (Continued)

(VCC = 5.0V, VEE = GND, TA=25°C, unless otherwise specified)

Parameter	Symbol	Conditions	KA224A			KA324A			Unit	
			Min.	Typ.	Max.	Min.	Typ.	Max.		
Input Offset Voltage	V <sub>IO</sub>	V <sub>CM</sub> = 0V to V <sub>CC</sub> -1.5V V <sub>O(P)</sub> = 1.4V, R <sub>S</sub> = 0Ω (Note1)	-	1.0	3.0	-	1.5	3.0	mV	
Input Offset Current	I <sub>IO</sub>	V <sub>CM</sub> = 0V	-	2	15	-	3.0	30	nA	
Input Bias Current	I <sub>BIAS</sub>	V <sub>CM</sub> = 0V	-	40	80	-	40	100	nA	
Input Common-Mode Voltage Range	V <sub>I(R)</sub>	Note1	0	-	V <sub>CC</sub> -1.5	0	-	V <sub>CC</sub> -1.5	V	
Supply Current	I <sub>CC</sub>	V <sub>CC</sub> = 30V, R <sub>L</sub> = ∞	-	1.5	3	-	1.5	3	mA	
		V <sub>CC</sub> = 5V, R <sub>L</sub> = ∞	-	0.7	1.2	-	0.7	1.2	mA	
Large Signal Voltage Gain	G <sub>V</sub>	V <sub>CC</sub> = 15V, R <sub>L</sub> = 2kΩ V <sub>O(P)</sub> = 1V to 11V	50	100	-	25	100	-	V/mV	
Output Voltage Swing	V <sub>O(H)</sub>	Note1	R <sub>L</sub> = 2kΩ	26	-	-	26	-	-	V
			R <sub>L</sub> = 10kΩ	27	28	-	27	28	-	V
	V <sub>O(L)</sub>	V <sub>CC</sub> = 5V, R <sub>L</sub> = 10kΩ	-	5	20	-	5	20	mV	
Common-Mode Rejection Ratio	CMRR	-	70	85	-	65	85	-	dB	
Power Supply Rejection Ratio	PSRR	-	65	100	-	65	100	-	dB	
Channel Separation	CS	f = 1kHz to 20kHz (Note2)	-	120	-	-	120	-	dB	
Short Circuit to GND	I <sub>SC</sub>	V <sub>CC</sub> = 15V	-	40	60	-	40	60	mA	
Output Current	I <sub>SOURCE</sub>	V <sub>I(+)</sub> = 1V, V <sub>I(-)</sub> = 0V V <sub>CC</sub> = 15V, V <sub>O(P)</sub> = 2V	20	40	-	20	40	-	mA	
	I <sub>SINK</sub>	V <sub>I(+)</sub> = 0V, V <sub>I(-)</sub> = 1V V <sub>CC</sub> = 15V, V <sub>O(P)</sub> = 2V	10	20	-	10	20	-	mA	
		V <sub>I(+)</sub> = 0V, V <sub>I(-)</sub> = 1V V <sub>CC</sub> = 5V, V <sub>O(P)</sub> = 200mV	12	50	-	12	50	-	μA	
Differential Input Voltage	V <sub>I(DIFF)</sub>	-	-	-	V <sub>CC</sub>	-	-	V <sub>CC</sub>	V	

**Note:**

- V<sub>CC</sub>=30V for KA224 / KA224A , KA324 / KA324A
- This parameter, although guaranteed, is not 100% tested in production.

**Electrical Characteristics** (Continued)

(VCC = 5.0V, VEE = GND, unless otherwise specified)

The following specifications apply over the range of  $-25^{\circ}\text{C} \leq T_A \leq +85^{\circ}\text{C}$  for the KA224A; and the  $0^{\circ}\text{C} \leq T_A \leq +70^{\circ}\text{C}$  for the KA324A

Parameter	Symbol	Conditions	KA224A			KA324A			Unit	
			Min.	Typ.	Max.	Min.	Typ.	Max.		
Input Offset Voltage	V <sub>IO</sub>	V <sub>CM</sub> = 0V to V <sub>CC</sub> -1.5V V <sub>O(P)</sub> = 1.4V, R <sub>S</sub> = 0Ω (Note1)	-	-	4.0	-	-	5.0	mV	
Input Offset Voltage Drift	ΔV <sub>IO</sub> /ΔT	R <sub>S</sub> = 0Ω (Note2)	-	7.0	20	-	7.0	30	μV/°C	
Input Offset Current	I <sub>IO</sub>	V <sub>CM</sub> = 0V	-	-	30	-	-	75	nA	
Input Offset Current Drift	ΔI <sub>IO</sub> /ΔT	R <sub>S</sub> = 0Ω (Note2)	-	10	200	-	10	300	pA/°C	
Input Bias Current	I <sub>BIAS</sub>	V <sub>CM</sub> = 0V	-	40	100	-	40	200	nA	
Input Common-Mode Voltage Range	V <sub>I(R)</sub>	Note1	0	-	V <sub>CC</sub> -2.0	0	-	V <sub>CC</sub> -2.0	V	
Large Signal Voltage Gain	G <sub>V</sub>	V <sub>CC</sub> = 15V, R <sub>L</sub> = 2.0kΩ	25	-	-	15	-	-	V/mV	
Output Voltage Swing	V <sub>O(H)</sub>	Note1	R <sub>L</sub> = 2kΩ	26	-	-	26	-	-	V
			R <sub>L</sub> = 10kΩ	27	28	-	27	28	-	V
	V <sub>O(L)</sub>	V <sub>CC</sub> = 5V, R <sub>L</sub> = 10kΩ	-	5	20	-	5	20	mV	
Output Current	I <sub>SOURCE</sub>	V <sub>I(+)</sub> = 1V, V <sub>I(-)</sub> = 0V V <sub>CC</sub> = 15V, V <sub>O(P)</sub> = 2V	10	20	-	10	20	-	mV	
	I <sub>SINK</sub>	V <sub>I(+)</sub> = 0V, V <sub>I(-)</sub> = 1V V <sub>CC</sub> = 15V, V <sub>O(P)</sub> = 2V	5	8	-	5	8	-	mA	
Differential Input Voltage	V <sub>I(DIFF)</sub>	-	-	-	V <sub>CC</sub>	-	-	V <sub>CC</sub>	V	

**Note:**

- V<sub>CC</sub> = 30V for KA224A and KA324A.
- These parameters, although guaranteed, are not 100% tested in production.

## Typical Performance Characteristics

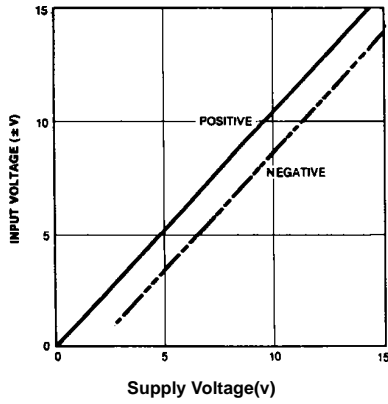

Figure 1. Input Voltage Range vs Supply Voltage

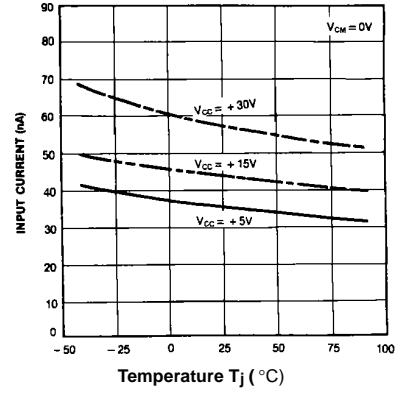

Figure 2. Input Current vs Temperature

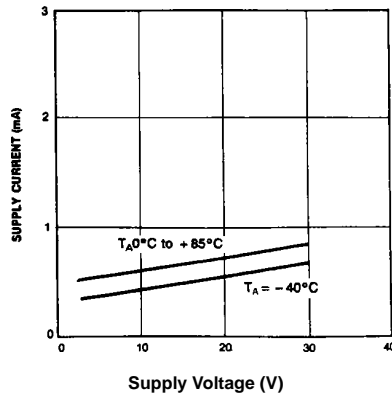

Figure 3. Supply Current vs Supply Voltage

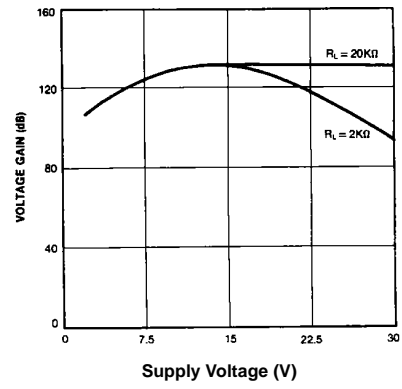

Figure 4. Voltage Gain vs Supply Voltage

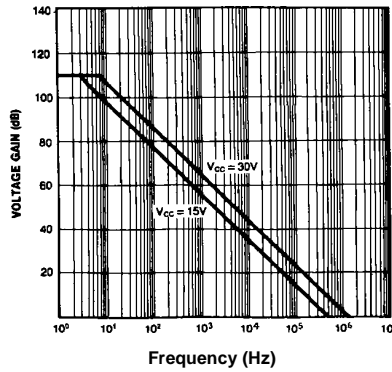

Figure 5. Open Loop Frequency Response

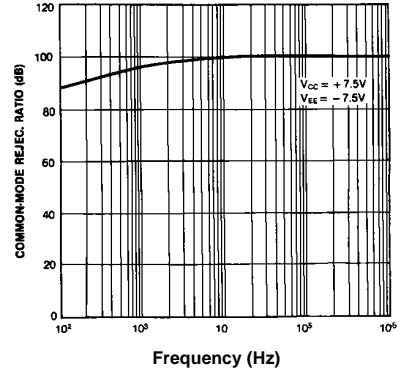

Figure 6. Common mode Rejection Ratio

# Typical Performance Characteristics (Continued)

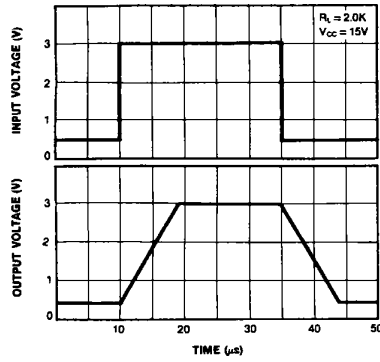

Figure 7. Voltage Follower Pulse Response

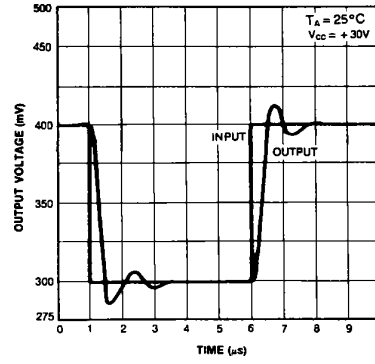

Figure 8. Voltage Follower Pulse Response (Small Signal)

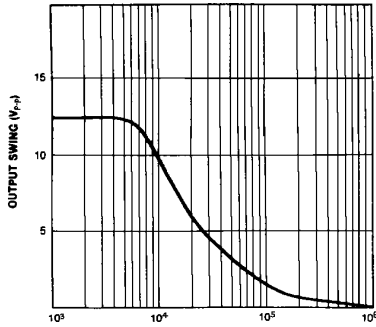

Figure 8. Large Signal Frequency Response

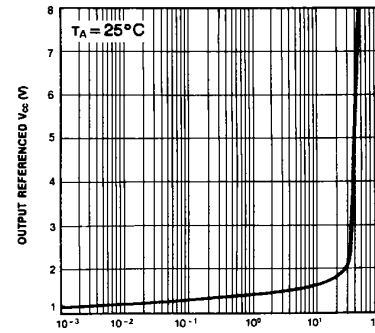

Figure 9. Output Characteristics vs Current Sourcing

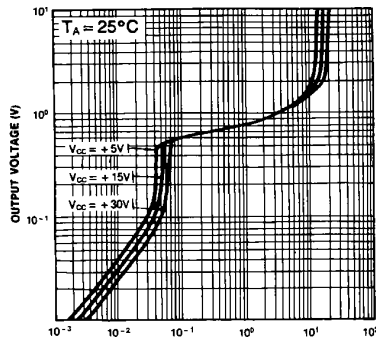

Figure 10. Output Characteristics vs Current Sinking

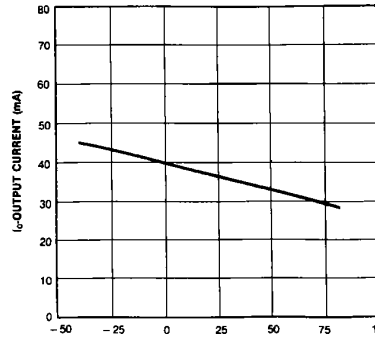

Figure 11. Current Limiting vs Temperature

# Mechanical Dimensions

## Package

Dimensions in millimeters

### 14-DIP

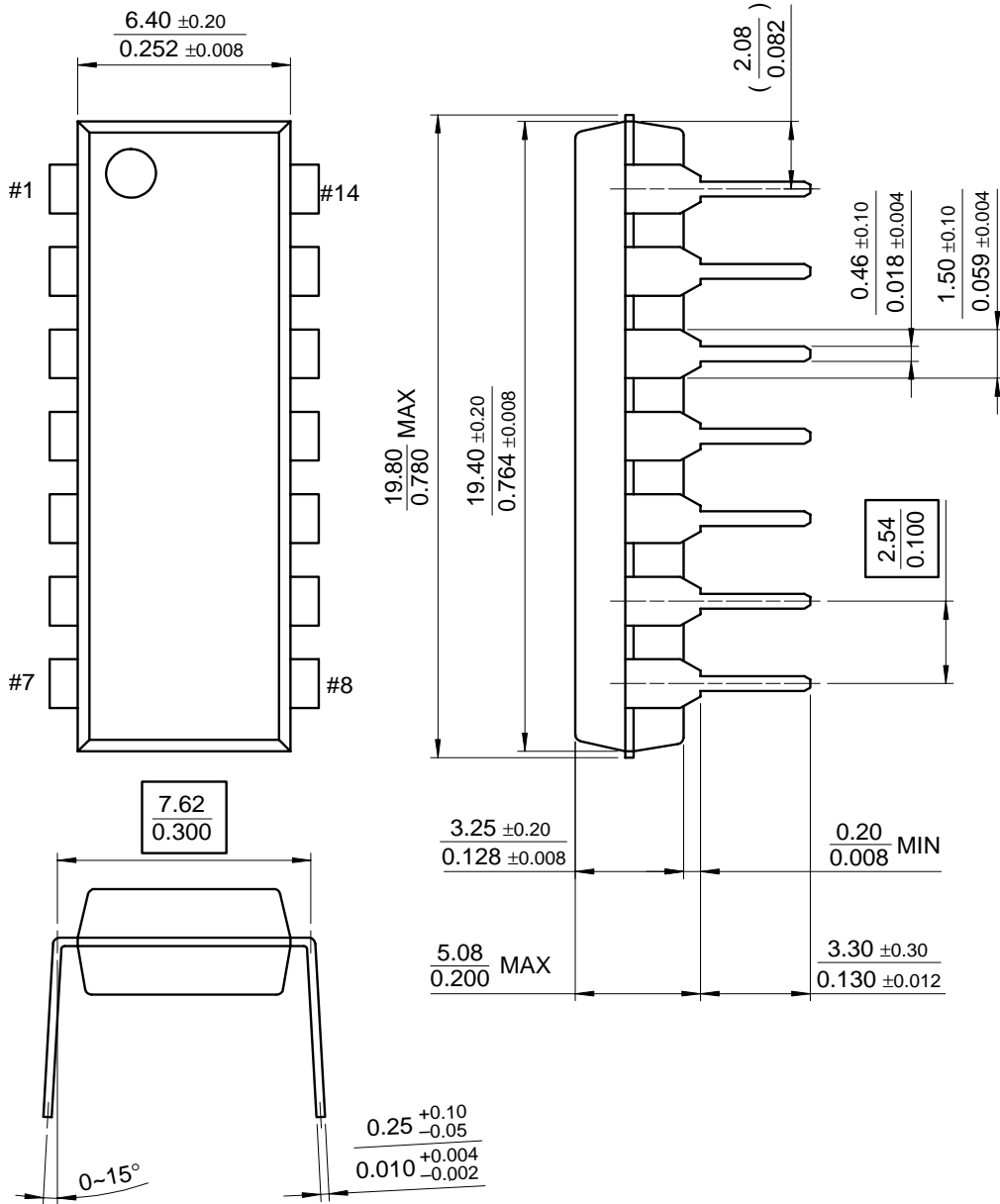

# Mechanical Dimensions (Continued)

Package

Dimensions in millimeters

## 14-SOP

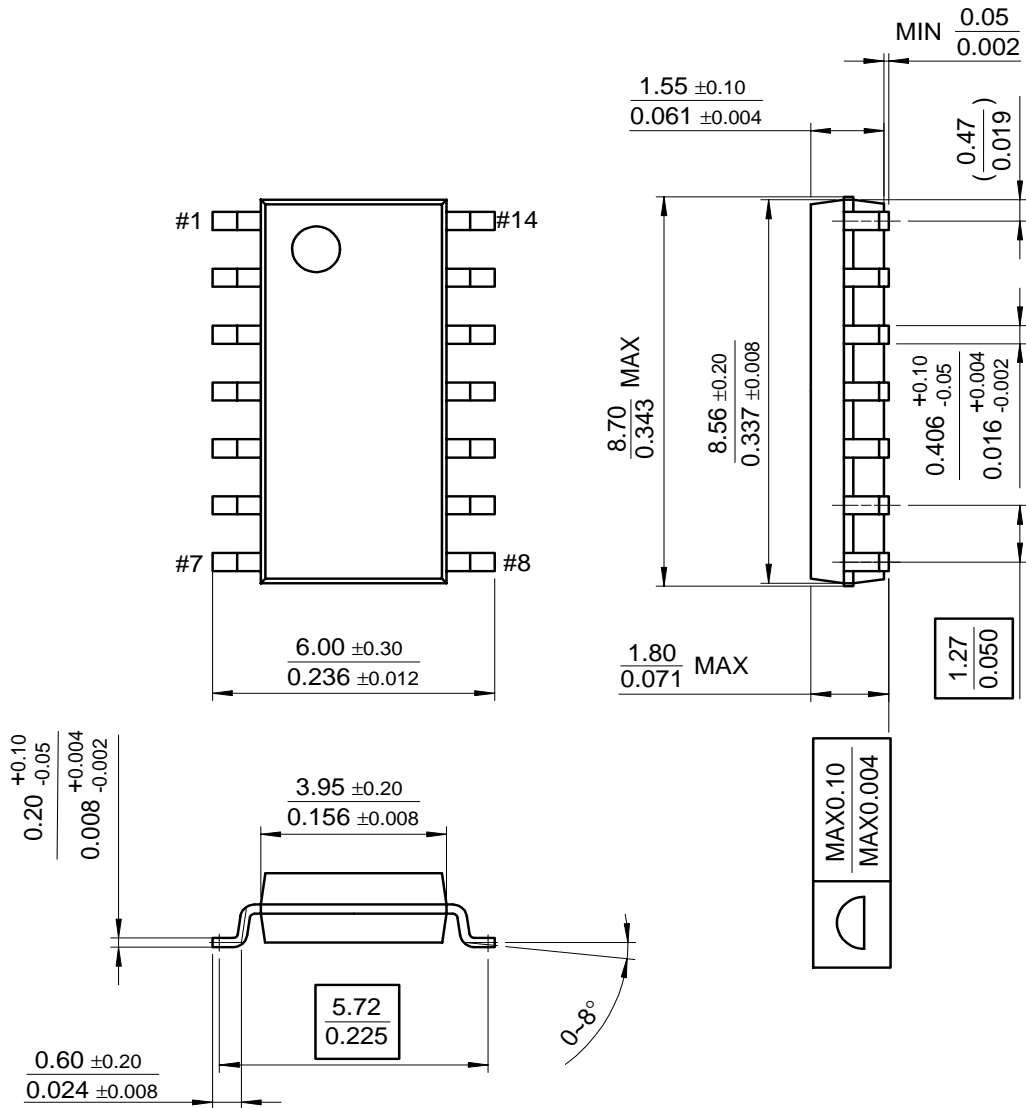

---

## Ordering Information

Product Number	Package	Operating Temperature
KA324	14-DIP	0 ~ +70°C
KA324A		
KA324D	14-SOP	
KA324AD		
KA224	14-DIP	-25 ~ +85°C
KA224A		
KA224D	14-SOP	
KA224AD		
KA2902	14-DIP	-40 ~ +85°C
KA2902D	14-SOP	

#### **DISCLAIMER**

FAIRCHILD SEMICONDUCTOR RESERVES THE RIGHT TO MAKE CHANGES WITHOUT FURTHER NOTICE TO ANY PRODUCTS HEREIN TO IMPROVE RELIABILITY, FUNCTION OR DESIGN. FAIRCHILD DOES NOT ASSUME ANY LIABILITY ARISING OUT OF THE APPLICATION OR USE OF ANY PRODUCT OR CIRCUIT DESCRIBED HEREIN; NEITHER DOES IT CONVEY ANY LICENSE UNDER ITS PATENT RIGHTS, NOR THE RIGHTS OF OTHERS.

#### **LIFE SUPPORT POLICY**

FAIRCHILD'S PRODUCTS ARE NOT AUTHORIZED FOR USE AS CRITICAL COMPONENTS IN LIFE SUPPORT DEVICES OR SYSTEMS WITHOUT THE EXPRESS WRITTEN APPROVAL OF THE PRESIDENT OF FAIRCHILD SEMICONDUCTOR CORPORATION. As used herein:

1. Life support devices or systems are devices or systems which, (a) are intended for surgical implant into the body, or (b) support or sustain life, and (c) whose failure to perform when properly used in accordance with instructions for use provided in the labeling, can be reasonably expected to result in a significant injury of the user.
2. A critical component in any component of a life support device or system whose failure to perform can be reasonably expected to cause the failure of the life support device or system, or to affect its safety or effectiveness.



LittleDiode supplies new, hard to find or obsolete electronic components and semiconductors all over the world.

With over two million different components listed you are sure to find the part you need.

Feel free to visit us today at our online store:

[LittleDiode.com](http://LittleDiode.com)

Looking forward to providing you with the best possible service.