

Comlinear CLC520 Amplifier with Voltage Controlled Gain, AGC+Amp

General Description

The CLC520 is a wideband DC-coupled amplifier with voltage-controlled gain (AGC). The amplifier has a high-impedance, differential signal input, a high-bandwidth gain control input and a single-ended voltage output. Signal channel performance is outstanding with 160MHz small signal bandwidth, 0.5 degree linear phase deviation (to 60MHz) and 0.04% signal nonlinearity at 4V_{pp} output.

Gain-control is very flexible. Maximum gain may be set over a nominal range of 2 to 100 with one external resistor. In addition, the gain-control input provides more than 40dB of voltage-controlled gain adjustment from the maximum gain setting. For example, a CLC520 may be set for a maximum gain of 2 (or 6dB) for a voltage-controlled gain range from 6dB to less than -34dB. Alternatively, the CLC520 could be set for a maximum gain of 100 (40dB) for a voltage-controlled gain range from 40dB to less than 0dB.

Besides being flexible, the gain-control is easy to use. Gain-control bandwidth is superb, 100MHz, simplifying AGC/ALC loop stabilization. And since the gain is minimum with a zero volt input and maximum with a +2 volt input, driving the control input is simple.

Finally, differential inputs, and a ground-referenced voltage output take the trouble out of designing DC-coupled AGC circuits for display normalizers, etc. The CLC520 is available in several versions:

CLC520AJP	-40°C to +85°C	8-pin plastic DIP
CLC520AJE	-40°C to +85°C	8-pin plastic SOIC
CLC520ALC	-40°C to +85°C	dice
CLC520AMC	-55°C to +125°C	dice qualified to Method 5008, MIL-STD-883, Level B
CLC520A8D	-55°C to +125°C	8-pin sidebraced CERDIP, MIL-STD-883, Level B

DESC SMD number: 5962-91694

Features

- 160MHz, -3dB bandwidth
- 2000V/μsec slew rate
- 0.04% signal nonlinearity at 4V_{pp} output
- -43dB feedthrough at 30MHz
- User adjustable gain range
- Differential voltage input and single-ended voltage output

Applications

- Wide-bandwidth AGC systems
- Automatic signal-leveling
- Video signal processing
- Voltage controlled filters
- Differential amplifier
- Amplitude modulation

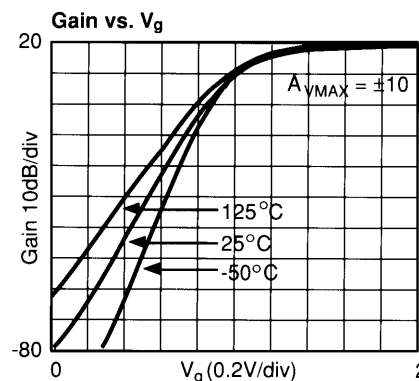

Package Dimensions

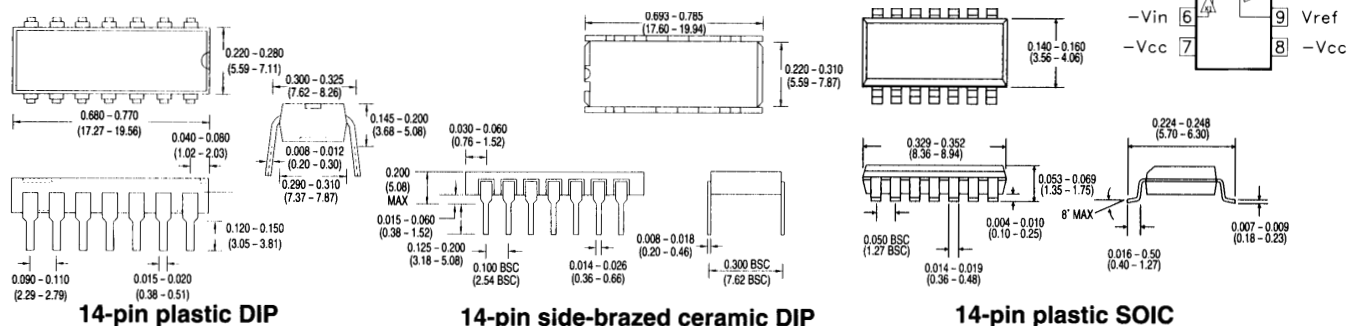

CLC520 Electrical Characteristics ($A_v = +10$, $V_{cc} = \pm 5V$, $R_L = 100\Omega$, $R_f = 1k\Omega$, $R_g = 182\Omega$, $V_g = +2V$)

PARAMETERS	CONDITIONS	TYP	MAX & MIN RATINGS			UNITS	SYMBOL
Ambient Temperature	CLC520A8/AL/AM	+25°C	-55°C	+25°C	+125°C		
Ambient Temperature	CLC520AJ/AI	+25°C	-40°C	+25°C	+85°C		
FREQUENCY DOMAIN RESPONSE							
† -3dB bandwidth	$V_{out} < 0.5V_{pp}$	160	>110	>120	>120	MHz	SSBW
	$V_{out} < 0.5V_{pp}$ (AJE only)	140	>90	>100	>100	MHz	SSBW
	$V_{out} < 4.0V_{pp}$	140	>85	>100	>100	MHz	LSBW
-3dB bandwidth	$V_{out} < 0.5V_{pp}$						
gain control channel	$V_{in} = +0.2V$, $V_g = +1VDC$	100	>80	>80	>80	MHz	SBWC
gain flatness	$V_{out} < 0.5V_{pp}$						
√ peaking	0.1MHz to 30MHz	0	<0.4	<0.3	<0.4	dB	GFPL
† peaking	0.1MHz to 20MHz	0	<0.7	<0.5	<0.7	dB	GFPH
√ rolloff	0.1MHz to 30MHz	0.1	<0.4	<0.3	<0.4	dB	GFRL
† rolloff	0.1MHz to 60MHz	0.5	<1.3	<1	<1.3	dB	GFRH
linear phase deviation	0.1MHz to 60MHz	0.5	<1.2	<1	<1.2	°	LPD
† feedthrough	$V_g = 0V$, $V_{in} = -22dBm$ at 30MHz	-43	<-38	<-38	<-38	dB	FDTH
	AJ only	-38	<-31	<-31	<-31	dB	FDTH
rise and fall time	0.5V step	2.5	<3.7	<3	<3	ns	TRS
	4.0V step	3.7	<5	<5	<5	ns	TRL
settling time to $\pm 0.1\%$	2.0V step	12	<18	<18	<18	ns	TS
overshoot	0.5V step	0	<15	<15	<15	%	OS
slew rate	4V step	2000	>1450	>1450	>1450	V/ μ sec	SR
†2nd harmonic distortion	$2V_{pp}$, 20MHz	-47	<-40	<-40	<-35	dBc	HD2
†3rd harmonic distortion	$2V_{pp}$, 20MHz	-60	<-50	<-50	<-45	dBc	HD3
equivalent output noise	(+10 for input noise) ¹						
noise floor	1MHz to 200MHz	-132	<-130	<-130	<-129	dBm/Hz	SNF
integrated noise	1MHz to 200MHz	800	<1000	<1000	<1100	μ V	INV
differential gain ²	at 3.58MHz	0.15				%	DG
differential phase ²	at 3.58MHz	0.15				°	DP
STATIC, DC PERFORMANCE							
integral signal nonlinearity	$V_{out} = 4V_{pp}$	0.04	<0.1	<0.1	<0.2	%	SGNL
gain accuracy	$R_f = 1k\Omega$, $R_g = 182\Omega$						
for nominal max gain = 20dB		± 0	± 1.0	± 0.5	± 0.5	dB	GACCU
*output offset voltage		40	<150	<120	<150	mV	VOS
average temperature coefficient		100	<400	—	<300	μ V/°C	DVOS
*input bias current		12	<61	<28	<28	μ A	IB
average temperature coefficient		100	<415	—	<165	nA/°C	DIB
input offset current		0.5	<4	<2	<2	μ A	IOS
average temperature coefficient		5	<40	—	<20	nA/°C	DIOS
†power supply sensitivity	output referred DC	10	<28	<28	<28	MV/V	PSS
common mode rejection ratio	input referred	70	>59	>59	>59	dB	CMRR
*supply current	no load	28	<38	<38	<38	mA	ICC
V_{in} signal input	resistance	200	>50	>100	>100	k Ω	RIN
	capacitance	1	<2	<2	<2	pF	CIN
V_{in} differential voltage range	for $R_g = 182\Omega$ only	± 280	± 250	± 250	± 210	mV	DMIR
V_{in} common mode voltage range		± 2.2	>1.4	>2	>2	V	CMIR
V_g control input	resistance	750	>535	>600	>600	Ω	RINC
	capacitance	1	<2	<2	<2	pF	CINC
V_g input voltage	for maximum gain	1.6	<2	<2	<2	k Ω	VGHI
	for minimum gain	0.4	>0	>0	>0	V	VGLO
output impedance	at DC	0.1	<0.3	<0.2	<0.2	Ω	RO
output voltage range	no load	± 3.5	± 3	± 3.2	± 3.2	V	VO
output current	-40°C to +85°C	± 70	± 35	± 50	± 50	mA	IO
	-55°C to +125°C	± 70	± 30	± 50	± 50	mA	IO

Min/max ratings are based on product characterization and simulation. Individual parameters are tested as noted. Outgoing quality levels are determined from tested parameters.

Absolute Maximum Ratings

V_{cc}	$\pm 7V$
I_{out}	output is short circuit protected to ground, however, maximum reliability is obtained if I_{out} does not exceed...
common mode input voltage	70mA
V_{in} differential input voltage	$\pm V_{cc}$
V_g input voltage	10V
V_{ref} input voltage	$\pm V_{cc}$
junction temperature	$\pm V_{cc}$
operating temperature range	+175°C
AJ/AI	-40°C to +85°C
A8/AL/AM	-55°C to +125°C
storage temperature range	-65°C to +150°C
lead solder duration (+300°C)	10 sec

Miscellaneous Ratings

recommended gain range:	± 2 to ± 100
recommended V_{REF}	$\pm 150mV$
Notes:	
* AI, AJ	100% tested at +25°C, sample at +85°C.
† AJ	Sample tested at +25°C.
† AI	100% tested at +25°C.
* A8	100% tested at +25°C, -55°C, +125°C.
† A8	100% tested at +25°C, sample -55°C, +125°C.
√ A8	100% tested at +25°C
* AL/AM	100% wafer probe tested at +25°C to +25°C min/max specifications
note 1:	Measured at $A_{vmax} = 10$, $V_g = +2V$
note 2:	Differential gain and phase are measured at: $A_v = +20$, $V_g = +2V$, $R_L = 150\Omega$, $R_f = 2k\Omega$, $R_g = 182\Omega$, equivalent video signal of 0-100 IRE with 40 IRE _{pp} at 3.58 MHz.

Typical Performance Characteristics ($T_A = 25^\circ$, $A_{VMAX} = \pm 10$, $V_{CC} = \pm 5V$, $R_L = 100\Omega$, $R_f = 1k\Omega$, $R_g = 182\Omega$, $V_g = +2V$)

Frequency Response, $A_{VMAX} = \pm 2$

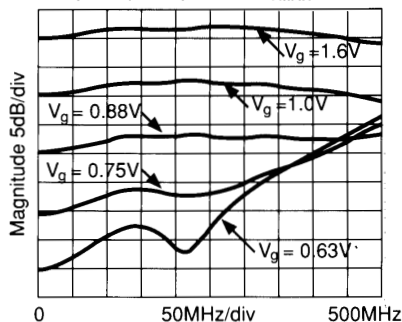

Frequency Response, $A_{VMAX} = \pm 10$

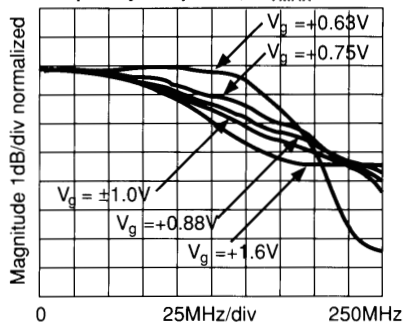

Frequency Response, $A_{VMAX} = \pm 100$

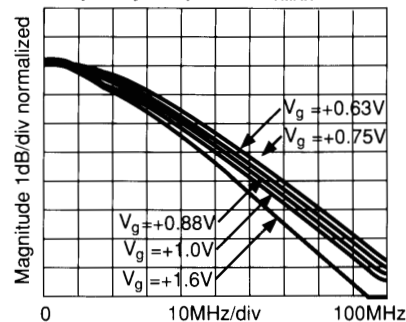

Large Signal Frequency Response

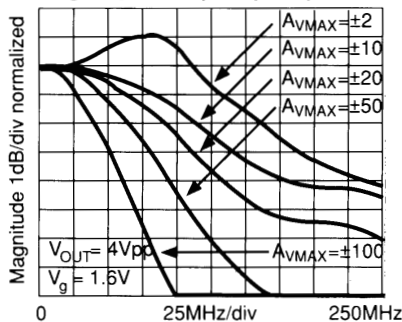

Small Signal Gain vs. R_f

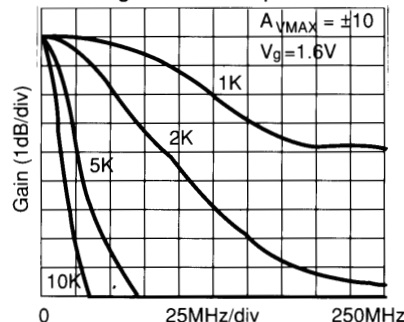

2nd Harmonic Distortion

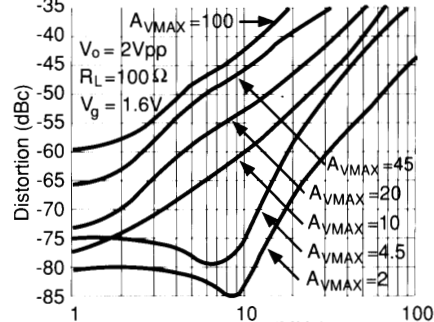

3rd Harmonic Distortion

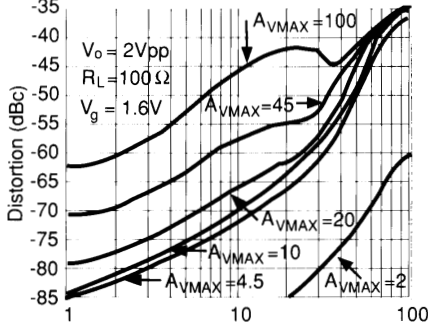

2nd and 3rd Harmonic Distortion vs. V_g

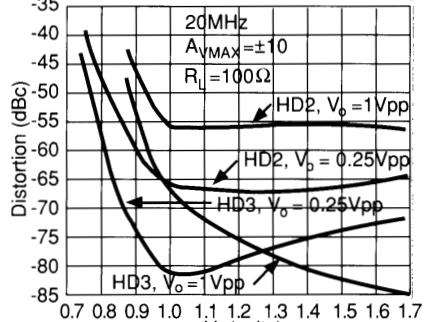

Gain vs. V_g

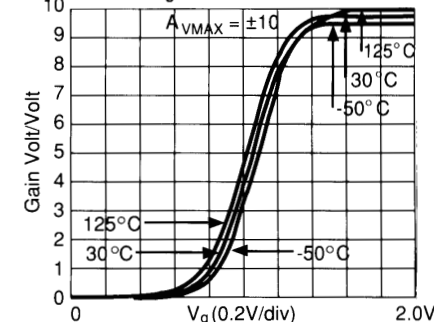

Gain vs. V_g

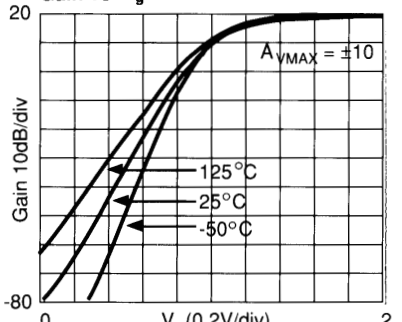

Large and Small Signal Pulse Response

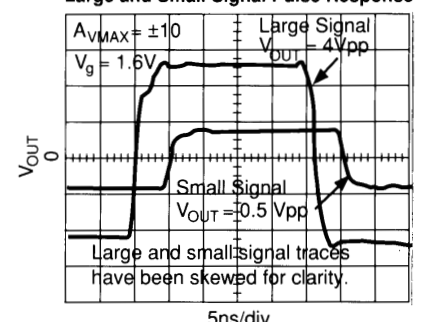

Settling Time, $V_g = 2V$

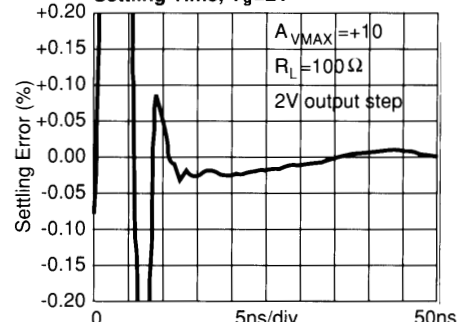

Settling Time, $V_g = 1.2V$

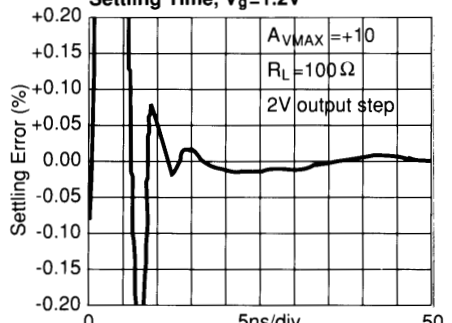

Long-Term Settling Time

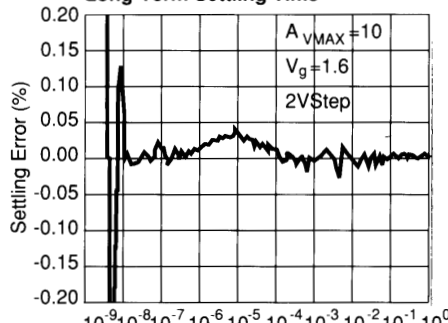

Settling Time vs. Capacitive Load, $A_{VMAX} = \pm 10$

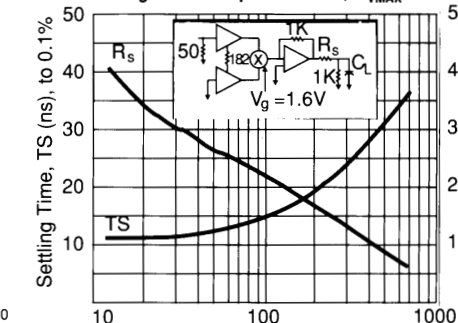

Typical Performance Characteristics ($T_A = 25^\circ$, $A_V = +10$, $V_{CC} = \pm 5V$, $R_L = 100\Omega$, $R_f = 1k\Omega$, $R_g = 182\Omega$, $V_g = +2V$)

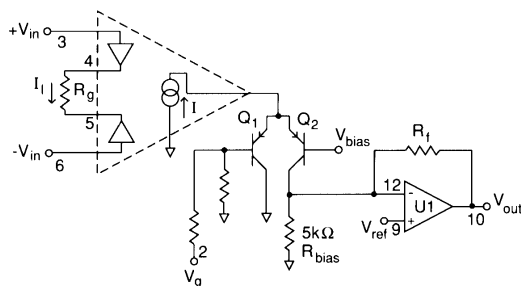
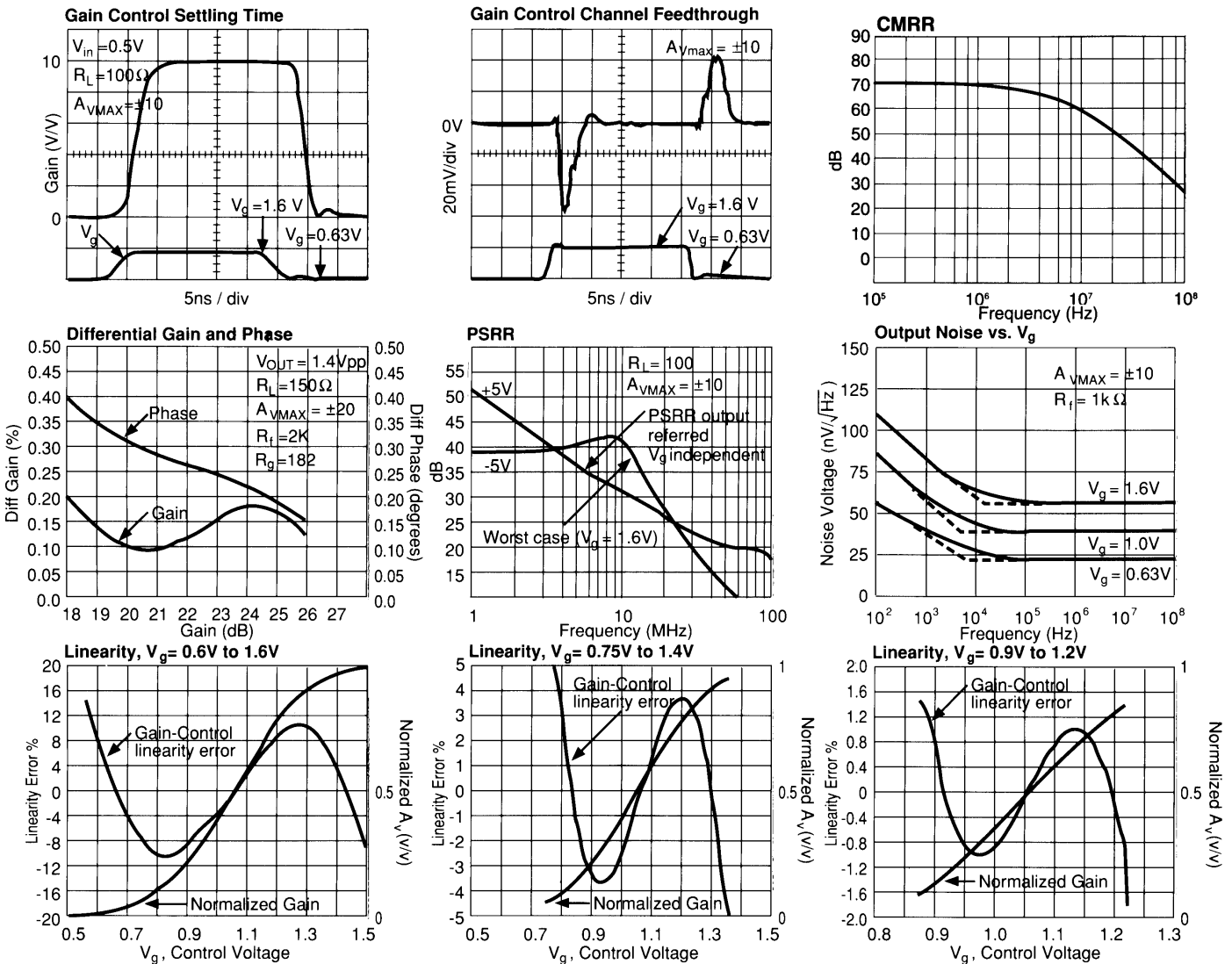

Figure 1: CLC520 Simplified Schematic

Simplified Circuit Description

A simplified schematic for the CLC520 is given in Figure 1. $+V_{in}$ and $-V_{in}$ are buffered with closed-loop voltage followers inducing a signal current in R_g proportional to $(+V_{in}) - (-V_{in})$, the differential input voltage. This current controls a current source which supplies two well-matched transistors, Q1 and Q2.

The current flowing through Q2 is converted to the final output voltage using R_f and output amplifier, U1. By changing the fraction of the signal current I which flows through Q2 the

gain is changed. This is done by changing the voltage applied differentially to the bases of Q1 and Q2. For example, with $V_g = 0$, Q1 conducts heavily and Q2 is off. With none of I flowing through R_f , the CLC520's input to output gain is strongly attenuated. With $V_g = 2V$, Q1 is off and all of the signal current flows through Q2 to R_f producing maximum gain. With V_g set to 1.1V, the bases of Q1 and Q2 are set to approximately the same voltage, Q1 and Q2 have the same collector currents – equal to one half of signal current I, thus the gain is approximately one half the maximum gain at $V_g = 1.1V$.

Typical application circuit

Figure 2 illustrates a voltage-controlled gain block offering broadband performance in a 50Ω system environment. The input signal is applied to pin 3 of the CLC520 and terminating resistor R2. Gain-control signals are applied to pin 2. The net gain-control port input impedance is 50Ω, set by the parallel combination of R1 and the 750Ω input impedance of pin 2 of the CLC520.

R_f is set to the standard value, 1kΩ, and R_g sets the maximum voltage gain (with a high Z load connected to the output) to 10V/V. Output impedance is set by R_o to 50Ω so with 50Ω source and load terminations, the gain is approximately 14dB.

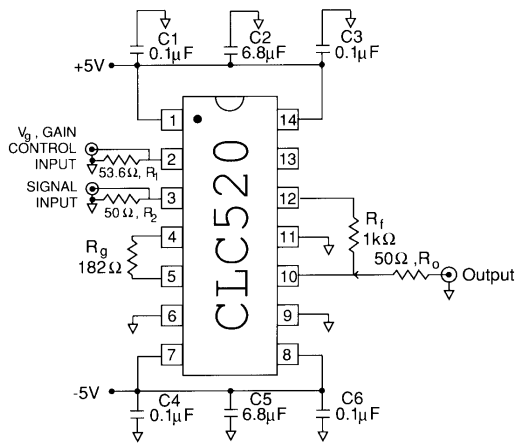

Figure 2: CLC520 Typical Application Circuit

Capacitors C1-C6 provide broadband power-supply bypassing. C2 and C5 should be tantalum capacitors. All other capacitors should be high-quality ceramic capacitors (CK-05 or equivalent).

Adjusting offset

Offset can be broken into two parts: an input-referred and an output-referred term. The input-referred offset shows up as a variation in output voltage as V_g is changed. This can be trimmed using the circuit in Figure 3 by placing a low frequency square wave ($V_l=0V$, $V_h=2V$) into V_{in} (with V_{in} set to zero volts) and adjusting R1 until the CLC520 output produces a steady DC value. After adjusting the input-referred offset, adjust R2 (with $V_{in}=0$, $V_g=0$) until V_{out} is zero. Finally, in inverting applications V_{in} may be applied to pin 6 and the offset adjustment to pin 3. This offset trim does not improve output offset temperature coefficient.

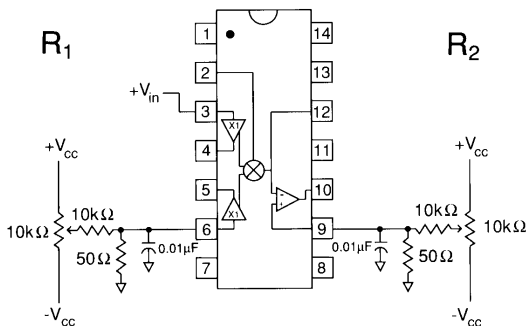

Figure 3: CLC520 Offset Adjustment Circuitry (other external elements not shown)

Selecting component values

Maximum input amplitude and maximum gain are the two key specifications that determine component values in a CLC520 application.

The output stage op amp is a current-feedback type amplifier optimized for $R_f=1k\Omega$. R_g can then be computed as:

$$R_g = \frac{R_f \cdot 1.85}{A_{vmax}} - 3.0\Omega \text{ with } R_f = 1k\Omega \quad (1)$$

To determine whether the maximum input amplitude will overdrive the CLC520, compute:

$$V_{dmax} = (R_g + 3.0\Omega) \cdot 0.00135 \quad (2)$$

the maximum differential input voltage for linear operation.

If the maximum input amplitude exceeds this limit, the CLC520 should either be moved to a location in the signal chain where amplitudes are reduced, A_{vmax} should be reduced or the values for R_g and R_f should be increased.

If the input amplitude is reduced, recompute the impact of the CLC520 on signal-to-noise ratio. If A_{vmax} is reduced,

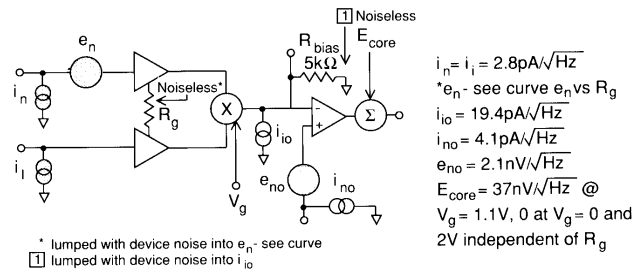

Figure 4: CLC520 Noise Model

“downstream” amplifier gain should be increased, or another gain stage added to make up for reduced A_{vmax} .

To increase R_g and R_f , compute the lowest acceptable value for R_g :

$$R_g > 740 \cdot V_{dmax} - 3\Omega \quad (3)$$

where $V_{dmax} = (+V_{in}) - (-V_{in})$, the largest expected peak differential input voltage. Operating with R_g larger than this value insures linear operation of the input buffers.

R_f may be computed from the selected R_g and A_{vmax} :

$$R_f = \frac{A_{vmax} \cdot (R_g + 3.0\Omega)}{1.85} \quad (4)$$

R_f should be $\geq 1k\Omega$. $R_f < 1k\Omega$ can be implemented using a loop gain reducing resistor to ground on the inverting summing node of the output amplifier (see application note OA-13).

Printed Circuit Layout

A good high-frequency PCB layout including ground plane construction and power supply bypassing close to the package are critical to achieving full performance. The amplifier is sensitive to stray capacitance to ground at the I- input (pin 12); keep trace area small. Shunt capacitance across the feedback resistor should not be used to compensate for this effect.

For best performance at low maximum gains ($A_{vmax} < 10$) R_{g+} and R_{g-} connections should be treated in a similar fashion. Capacitance to ground should be minimized by removing the ground plane from under the body of R_g .

Parasitic or load capacitance directly on the output (pin 10) degrades phase margin leading to frequency response peaking. A small series resistor before this capacitance, if present, effectively decouples this effect (see Settling Time vs. Capacitive Load).

Precision buffered resistors (PRP8351 series from Precision Resistive Products) must be used for R_f for rated performance. Precision buffered resistors are suggested for R_g for low gain settings ($A_{vmax} < 10$). Carbon composition resistors and RN55D metal-film resistors may be used with reduced performance.

Evaluation PC boards (part no. 730021) for the CLC520 are available from Comlinear at minimal cost.

Predicting the output noise

Seven noise sources (e_n , i_n , i_i , i_{io} , i_{no} , e_{no} , E_{core}) are used to model the CLC520 noise performance (Figure 4). e_n , i_n , and i_i model the equivalent input noise terms for the input buffer while i_{io} , i_{no} , and e_{no} model the noise terms for the output buffer. To simplify the model e_n includes the effect of resistor R_g (see Figure 5 for e_n vs R_g). To simplify the model further, R_{bias} is assumed noiseless and its noise contribution is included in i_{io} .

An additional term E_{core} mimics the active device noise contribution from the Gilbert multiplier core. Core noise is theoretically zero when the multiplier is set to maximum gain or zero gain ($V_g > 1.6V$ or $V_g < 0.63V$ respectively at room temperature) and reaches a maximum of $37nV/\sqrt{Hz}$ at $A_{vmax}/2$.

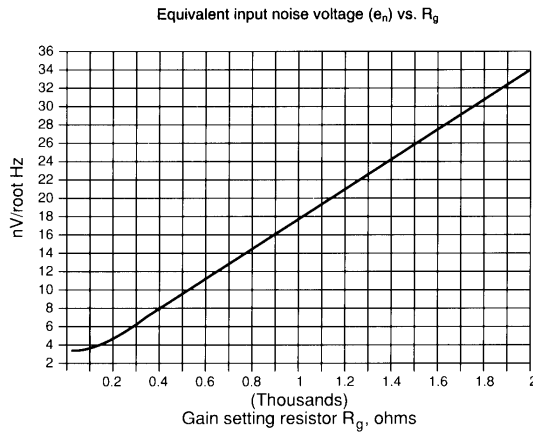

Figure 5

Several points should be made concerning this model. First, external component noise contributions need to be factored in when computing total output referred noise. The only exception is R_g , where its noise contribution is already factored in. Second, the model ignores flicker noise contributions. Applications where noise below approximately 100KHz must be considered should use this model with caution. Third this model very accurately predicts output noise voltage for the typical application circuit (see above) but will be less accurate the further component values deviate from those in the typical application circuit. In general, however, the model should predict the equivalent output noise above the flicker noise region to within a few dB of actual performance over the normal range of A_{vmax} and component values.

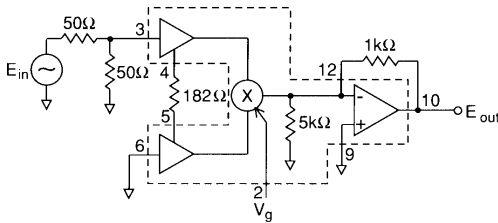

Figure 6: Typical Circuit

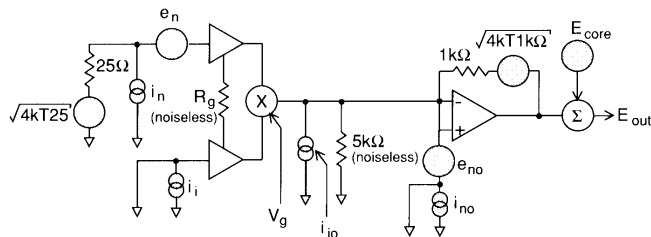

Figure 7: Noise Model for Typical Circuit

Calculating CLC520 output noise in a typical circuit

To calculate the noise in a CLC520 application, the noise terms given for the amplifier as well as the noise terms of the external components must be included. To clarify the techniques used, output noise in a typical circuit will be calculated. (Figure 6)

The noise model is depicted in Figure 7. The diagram assumes spot noise sources with V_{rms}/\sqrt{Hz} and $Amps_{rms}/\sqrt{Hz}$ units. The Thevenin equivalent of the source and input termination is used: 25Ω in series with a noise voltage source. R_g is assumed noiseless since its effect is included in e_n . The internal $5k\Omega$ resistor at the CLC520 core output is also assumed noiseless since its effect is included in i_{io} . The noise contribution from R_1 is modeled as a noise voltage source.

The easiest way to analyze the output noise of this circuit is to break the analysis into three pieces: an input buffer noise calculation, an output buffer noise calculation, and a core noise calculation. The output contribution of the input buffer varies with the gain. The output contribution of the output buffer is constant. The core noise contribution is zero at maximum and minimum gain and reaches a peak at $A_{vmax}/2$. Summing the noise powers for each of these terms gives the total output noise power.

Since we assume all noise terms are uncorrelated, the equivalent input noise voltage squared is given by:

$$E_{it}^2 = 4kT25 + (I_n 25)^2 + e_n^2$$

i_i does not contribute to the input buffer noise because the input buffer inverting input is grounded. e_n is taken from Figure 5.

The equivalent output buffer noise is given by:

$$E_{ot}^2 = (i_{io} \cdot 1k\Omega)^2 + 4kT(1k\Omega) + [e_{no} (1 + \frac{1k\Omega}{5k\Omega})]^2$$

I_{no} does not contribute to the output buffer noise because the output buffer non-inverting input is grounded.

The core noise is already output referred and is $37nV/\sqrt{Hz}$ at $V_g = 1.1$ ($A_{vmax}/2$) and approaches zero as A_v goes to 0 or A_{vmax} .

The total output noise voltage is given by:

$$E_{TOTAL}^2 = E_{it}^2 A_v^2 + E_{ot}^2 + C E_{core}^2$$

Where A_v is the input to output voltage gain (which varies as V_g varies).

C accounts for the variation in core noise contribution as V_g is adjusted. $C = 1$ when gain A_v is $A_{vmax}/2$. C is zero at A_{vmax} and $A_v = 0$ and varies between 0 and 1 for all other values.

Using these equations, total calculated output noise for the circuit was $20nV/\sqrt{Hz}$ at minimum gain, $49nV/\sqrt{Hz}$ at mid-gain, and $53nV/\sqrt{Hz}$ at maximum gain.

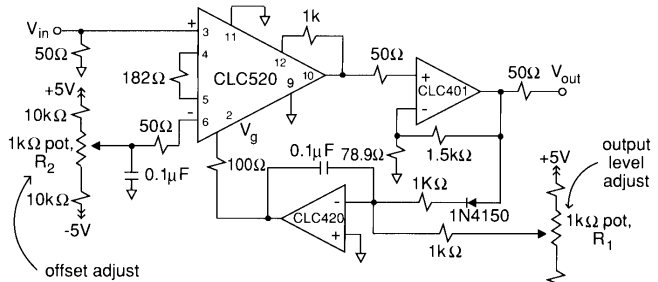

Figure 8: Automatic Gain Control (AGC) Loop

AGC circuits

Figure 8 shows a typical AGC circuit. The CLC520 is followed up with a CLC401 for higher overall gain. The output of the CLC401 is rectified and fed to an inverting integrator using a CLC420 (wideband voltage feedback op amp). When the output voltage, V_{out} , is too large the integrator output voltage ramps down reducing the net gain of the CLC520 and V_{out} . If the output voltage is too small, the integrator ramps up increasing the net gain and the output voltage. Actual output level is set with R_1 . To prevent shifts in DC output voltage with changes in input signal level, trim pot R_2 is provided. AGC circuits are always limited in the range of input signals over which constant output level can be maintained. In this circuit, we would expect that reasonable AGC action could be maintained over the gain adjustment range of the CLC520 (at least 40dB). In practice, rectifier dynamic range limits reduce this slightly.

Evaluation Board

Evaluation PC boards (part number 730029 for through-hole and 730023 for SOIC) for the CLC520 are available.

This page intentionally left blank.

Customer Design Applications Support

National Semiconductor is committed to design excellence. For sales, literature and technical support, call the National Semiconductor Customer Response Group at **1-800-272-9959** or fax **1-800-737-7018**.

Life Support Policy

National's products are not authorized for use as critical components in life support devices or systems without the express written approval of the president of National Semiconductor Corporation. As used herein:

1. Life support devices or systems are devices or systems which, a) are intended for surgical implant into the body, or b) support or sustain life, and whose failure to perform, when properly used in accordance with instructions for use provided in the labeling, can be reasonably expected to result in a significant injury to the user.
2. A critical component is any component of a life support device or system whose failure to perform can be reasonably expected to cause the failure of the life support device or system, or to affect its safety or effectiveness.



National Semiconductor Corporation

1111 West Bardin Road
Arlington, TX 76017
Tel: 1(800) 272-9959
Fax: 1(800) 737-7018

National Semiconductor Europe

Fax: (+49) 0-180-530 85 86
E-mail: europe.support.nsc.com
Deutsch Tel: (+49) 0-180-530 85 85
English Tel: (+49) 0-180-532 78 32
Francais Tel: (+49) 0-180-532 93 58
Italiano Tel: (+49) 0-180-534 16 80

National Semiconductor Hong Kong Ltd.

13th Floor, Straight Block
Ocean Centre, 5 Canton Road
Tsimshatsui, Kowloon
Hong Kong
Tel: (852) 2737-1600
Fax: (852) 2736-9960

National Semiconductor Japan Ltd.

Tel: 81-043-299-2309
Fax: 81-043-299-2408

National does not assume any responsibility for use of any circuitry described, no circuit patent licenses are implied and National reserves the right at any time without notice to change said circuitry and specifications.

National Semiconductor was acquired by Texas Instruments.

http://www.ti.com/corp/docs/investor_relations/pr_09_23_2011_national_semiconductor.html

This file is the datasheet for the following electronic components:

CLC520 - <http://www.ti.com/product/clc520?HQS=TI-null-null-dscatalog-df-pf-null-ww>



LittleDiode supplies new, hard to find or obsolete electronic components and semiconductors all over the world.

With over two million different components listed you are sure to find the part you need.

Feel free to visit us today at our online store:

LittleDiode.com

Looking forward to providing you with the best possible service.