

**RECTIFIER DIODES (BRIDGE TYPE) (Ta=25°C)**

Parts No.	Maximum ratings				Electrical characteristics			Fig. No.	Remarks
	V <sub>RM</sub> (V)	I <sub>o</sub> (A)	I <sub>FSM</sub> (A)	Tstg (°C)	V <sub>F</sub>	I <sub>R</sub>	Fig. No.		
					(V)	(μA)			
RB-150	50	1.5	40	-40~+140	0.95	1.0	10	16	
-151	100								
-152	200								
-154	400								
-156	600								
-158	800								
LB-156	600	1.5	120	-40~+140	0.91	1.0	10	16	
RBA-401	100	4.0‡	80	-40~+150	1.05	2.0	10	17	
-402	200								
RBV-404	400	4.0‡	60	-40~+150	1.10	2.0	10	18	
-406	600								
-408	800								
-406M	600								
-406H	600								
RBV-601	100								
-602	200								
-604	400								
-606	600								
-608	800								
RBV-1506	600	15‡	200	-40~+150	1.05	7.5	50	19	
-2506	600	25‡	350	-40~+150	1.05	12.5	50	19	

‡With fin

**HIGH VOLTAGE RECTIFIER DIODES (Ta=25°C)**

Parts No.	Maximum ratings					Electrical characteristics				Fig. No.
	V <sub>RM</sub> (kV)	I <sub>o</sub> (mA)	I <sub>FSM</sub> (A)	T <sub>c</sub> (°C)	Tstg (°C)	V <sub>F</sub>	I <sub>R</sub>	trr	Fig. No.	
						(V)	(μA)	(μs)		
SHV-02	2	2.0	0.5	100	-40~+120	16	10	1.0	0.18	20
SHV-03	3									
-06	6									
-08	8									
-10	10									
-12	12									
-14	14									
-16	16									
-20	20									
-24	24									
SHV-06NK	6									
-08NK	8									
-10K	10									
-12K	12									
-06UNK	6									
-08UNK	8									
-10UK	10									
-12UK	12									
-16UK	16									
-08X	8									
-08XN	8									

**MICROWAVE OVEN DIODES (Ta=25°C)**

Parts No.	Maximum ratings				Electrical characteristics			Fig. No.
	V <sub>RM</sub> (kV)	I <sub>o</sub> (mA)	I <sub>FSM</sub> (A)	Tstg (°C)	V <sub>F</sub>	I <sub>R</sub>	Fig. No.	
					(V)	(μA)		
HVR-IX-40B	9	350	20	-40~+130	9	350	10	26
UX-FOB	8	350	15	-30~+130	16	350	10	27

**HIGH SPEED RECTIFIER DIODES (Ta=25°C)**

Parts No.	Maximum ratings				Electrical characteristics				Fig. No.
	V <sub>RM</sub> (V)	I <sub>o</sub> (A)	I <sub>FSM</sub> (A)	Tstg (°C)	V <sub>F</sub>	I <sub>R</sub>	trr	Fig. No.	
					(V)	(μA)	(μs)		
RC 2	2000	0.2	20	-40~+130	2.0	0.2	10	4.0	3
RU 1	400	0.25	15	-40~+130	2.5	0.25	10	0.4	
1A	600								
1B	800								
1C	1000	0.2			3.0				
EU 1Z	200	0.25	15	-40~+140	2.5	0.25	10	0.4	4
1	400								
1A	600								
EU01Z	200	0.25*	15	-40~+140	2.5	0.25	10	0.4	5
O1	400								
O1A	600								
EPO1C	1000	0.2	5	-40~+140	4.0	0.2	5	0.2	5
EH 1Z	200	0.6	30	-40~+140	1.35	0.6	10	4.0	4
1	400								
1A	600								
RF 1Z	200	0.6	15	-40~+130	2.0	0.6	10	0.4	3
1	400								
1A	600								
1B	800								
RH 1Z	200	0.6	35	-40~+130	1.3	0.6	5	4.0	3
1	400								
1A	600								
1B	800								
1C	1000								
ASO1Z	200	0.6	20	-40~+150	1.50	0.6	10	1.5	2
O1	400								
O1A	600								
AP01C	1000	0.2	5	-40~+150	4.0	0.2	100	0.2	2
ESO1Z	200	0.7*	30	-40~+140	2.5	0.8	10	1.5	5
O1	400								
O1A	600								
O1F	1500	0.5*	20		2.0	0.5			
ES 1Z	200	0.7	30	-40~+140	2.5	0.8	10	1.5	4
1	400								
1A	600								
1F	1500	0.5	20		2.0	0.5			
RS 1A	600	0.7	30	-40~+130	2.5	0.8	10	1.5	3
1B	800								
RH 2F	1500	1.0	60	-40~+130	1.0	1.0	10	4.2	6
AU01Z	200	0.5	15	-40~+150	1.70	0.5	10	0.4	2
O1	400								
O1A	600								
AU02Z	200	0.8	25	-40~+150	1.30	0.8	10	0.4	2
O2	400								
O2A	600								
EPO1C	1000	0.2	5	-40~+140	4.0	0.2	5	0.2	5
RU 2Z	200	1.0	20	-40~+130	1.5	1.0	10	0.4	3
2	600								
2B	800								

\*With print substrate 27

**AVALANCHE DIODES**

(Ta=25°C)

Parts No.	Maximum ratings			Electrical characteristics			Fig. No.
	V <sub>RM</sub> (V)	I <sub>ZSM</sub> (A) Momentary	T <sub>stg</sub> (°C)	V <sub>Z</sub> (V) 1mA Momentary	I <sub>R</sub> (μA)	I <sub>RM</sub> (μA)	
RM 25	40	3.0	-40~+130	50~61.5	5	20	3
RM 26	50			60~70			
R 2M	130	1.0	-40~+150	135~180	10	50	3
RY 23	200	0.1	-40~+130	250~400	10	50	3
RY 24	400			400~450			

**POWER ZENER DIODES**

(Ta=25°C)

Parts No.	Maximum ratings				Electrical characteristics			Remarks	Fig. No.		
	P <sub>R</sub> (W)	V <sub>DC</sub> (V)	V <sub>ZSM</sub> (A) Momentary	T <sub>stg</sub> (°C)	V <sub>Z</sub> (V) 1mA Momentary	I <sub>R</sub> (mA)	H·I <sub>R</sub> (mA)				
PZ127	150	20	4	-40~+150	27±5	0.5	1.0		3		
227	300								8	6	
427	450								9	8	
628	1500								40		34

**GaAs SCHOTTKY BARRIER DIODES(GSC SERIES)**

**Maximum ratings**

(Ta=25°C)

Parts No.	V <sub>RM</sub> (V)	I <sub>O</sub> (A)	T <sub>C</sub> (°C)	I <sub>FSM</sub> * (A)		T <sub>J</sub> (°C)	T <sub>stg</sub> (°C)
				Rectangular wave duty 1/2 average	50Hz half sine wave peak value		
GSC215	150	5	114	20	2.0	-40~+150	-40~+150
GSC218	180						
GSC235	350	2	115	8	0.3		
GSC315	150	14	80	50	18		
GSC318	180						

\* Per element

**Electrical and thermal characteristics**

(Ta=25°C)

Parts No.	V <sub>F</sub> * (V)	I <sub>F</sub> (A)	I <sub>R</sub> * (mA)	I <sub>RMH</sub> * (mA)	trr* (ns)	C <sub>O</sub> * (pF)	P <sub>thc</sub> (C/W)	Fig. No.
GSC215	0.90	2.5	1.0	10	7	2	150	13
GSC218								
GSC235	1.50	1.0		4.5	5	1	100	
GSC315	0.90	7.0	3.0	30	10	6	450	14
GSC318								

\* Per element

● Full view (Unit: mm)

Fig. 1

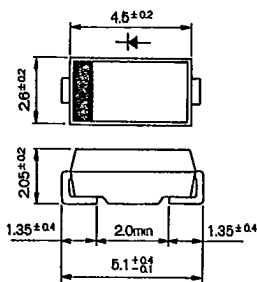

Fig. 2

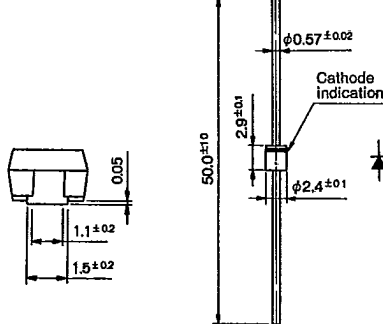

Fig. 3

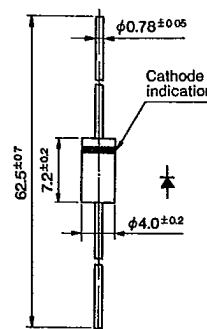

Fig. 4

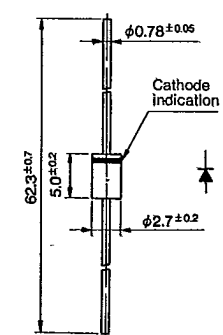

Fig. 5

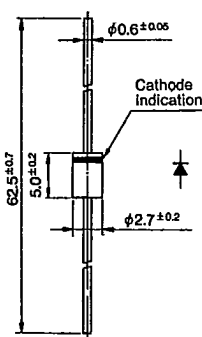

Fig. 6

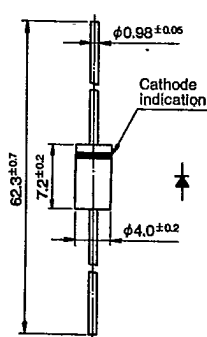

Fig. 7

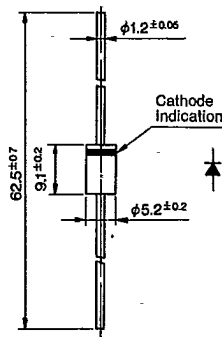

Fig. 8

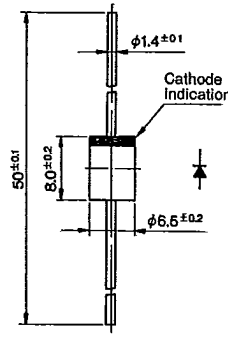

Fig. 9

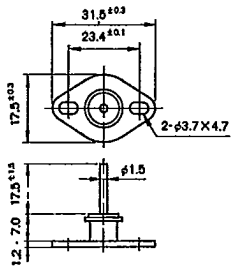

Fig. 10

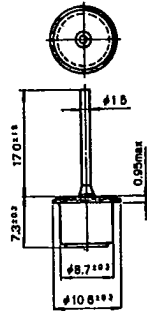

Fig. 11

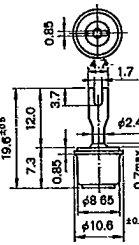

Fig. 12

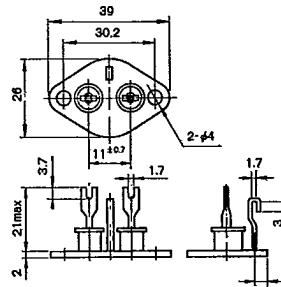

Fig. 13 (TO-220)

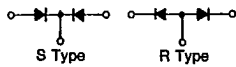
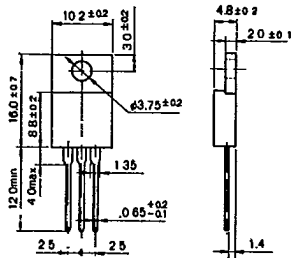

Fig. 14 (TO-3P)

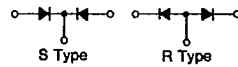
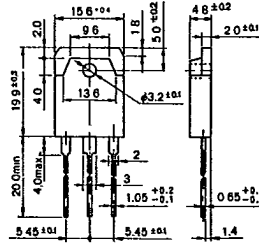

Fig. 15

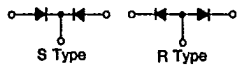
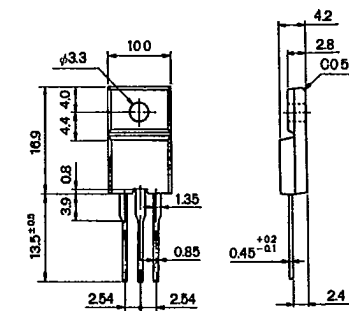
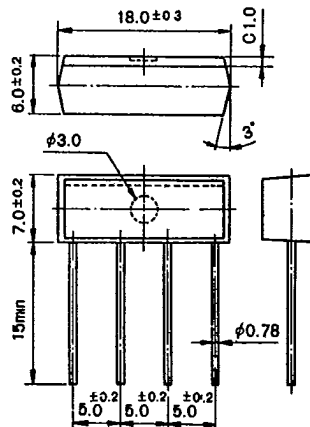

Fig. 16



~ - + ~

Fig. 17

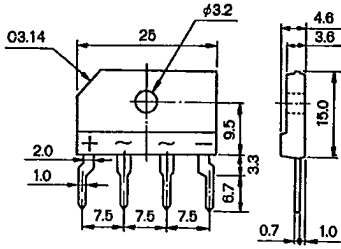

Fig. 18

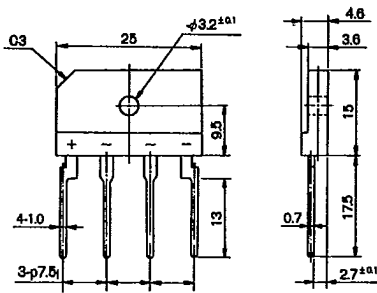

Fig. 19

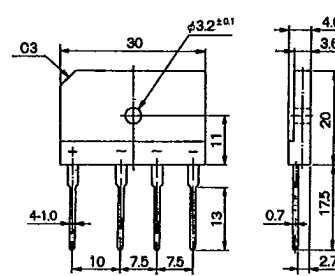

Fig. 20

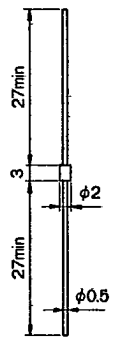

Fig. 21

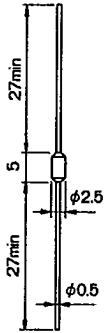

Fig. 22

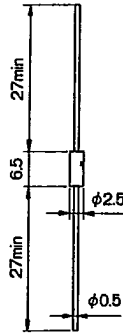

Fig. 23

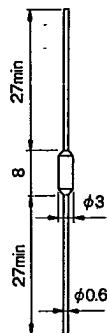

Fig. 24

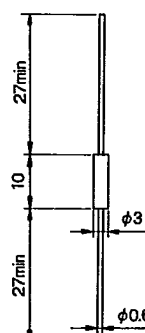

Fig. 25

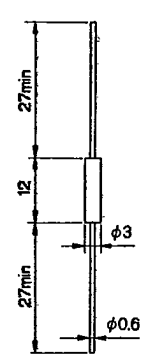

Fig. 26

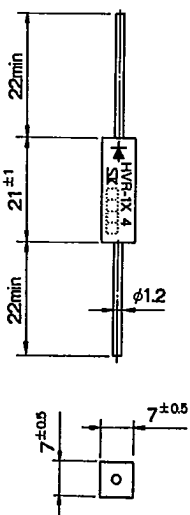

Fig. 27

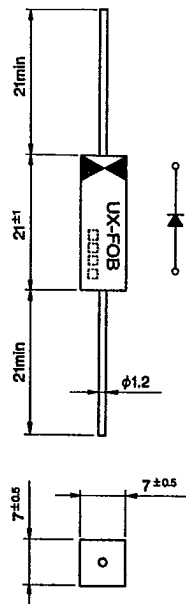

Fig. 28

