

100352

Low Power 8-Bit Buffer with Cut-Off Drivers

General Description

The 100352 contains an 8-bit buffer, individual inputs (D_n), outputs (Q_n), and a data output enable pin (\overline{OEN}). A Q output follows its D input when the \overline{OEN} pin is LOW. A HIGH on \overline{OEN} holds the outputs in a cut-off state. The cut-off state is designed to be more negative than a normal ECL LOW level. This allows the output emitter-followers to turn off when the termination supply is $-2.0V$, presenting a high impedance to the data bus. This high impedance reduces termination power and prevents loss of low state noise margin when several loads share the bus.

The 100352 outputs are designed to drive a doubly terminated 50Ω transmission line (25Ω load impedance). All inputs have $50\text{ k}\Omega$ pull-down resistors.

Features

- Cut-off drivers
- Drives 25Ω load
- Low power operation
- 2000V ESD protection
- Voltage compensated operating range = $-4.2V$ to $-5.7V$
- Available to industrial grade temperature range

Ordering Code:

Order Number	Package Number	Package Description
100352PC	N24E	24-Lead Plastic Dual-In-Line Package (PDIP), JEDEC MS-010, 0.400 Wide
100352QC	V28A	28-Lead Plastic Lead Chip Carrier (PLCC), JEDEC MO-047, 0.450 Square
100352QI	V28A	28-Lead Plastic Lead Chip Carrier (PLCC), JEDEC MO-047, 0.450 Square Industrial Temperature Range (-40°C to $+85^\circ\text{C}$)

Devices also available in Tape and Reel. Specify by appending the suffix letter "X" to the ordering code.

Logic Symbol

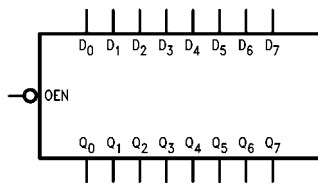

Connection Diagrams

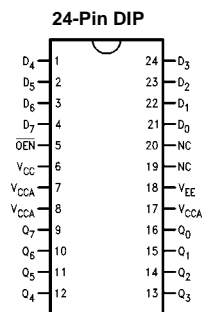

Pin Descriptions

Pin Names	Description
D_0 – D_7	Data Inputs
\overline{OEN}	Output Enable Input
Q_0 – Q_7	Data Outputs
NC	No Connect

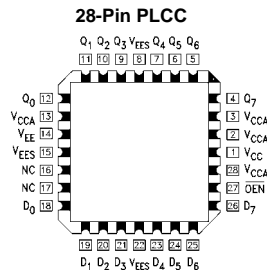

Truth Table

Inputs		Outputs
D_n	\overline{OEN}	Q_n
L	L	L
H	L	H
X	H	Cutoff

H = HIGH Voltage Level
 L = LOW Voltage Level
 Cutoff = Lower-than-LOW State
 X = Don't Care

Logic Diagram

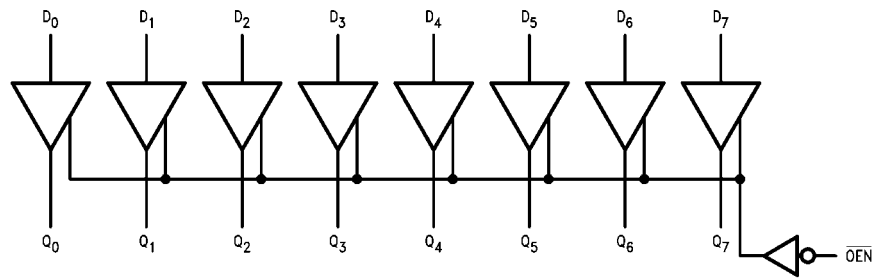

Absolute Maximum Ratings(Note 1)

Storage Temperature (T_{STG})	-65°C to +150°C
Maximum Junction Temperature (T_J)	+150°C
V_{EE} Pin Potential to Ground Pin	-7.0V to +0.5V
Input Voltage (DC)	V_{EE} to +0.5V
Output Current (DC Output HIGH)	-100 mA
ESD (Note 2)	≥2000V

Recommended Operating Conditions

Case Temperature (T_C)	Commercial	0°C to +85°C
	Industrial	-40°C to +85°C
Supply Voltage (V_{EE})		-5.7V to -4.2V

Note 1: The "Absolute Maximum Ratings" are those values beyond which the safety of the device cannot be guaranteed. The device should not be operated at these limits. The parametric values defined in the Electrical Characteristics tables are not guaranteed at the absolute maximum rating. The "Recommended Operating Conditions" table will define the conditions for actual device operation.

Note 2: ESD testing conforms to MIL-STD-883, Method 3015.

Commercial Version**DC Electrical Characteristics** (Note 3)

$V_{EE} = -4.2V$ to $-5.7V$, $V_{CC} = V_{CCA} = GND$, $T_C = 0^\circ C$ to $+85^\circ C$

Symbol	Parameter	Min	Typ	Max	Units	Conditions
V_{OH}	Output HIGH Voltage	-1025	-955	-870	mV	$V_{IN} = V_{IH} (Max)$ or $V_{IL} (Min)$ Loading with 25Ω to -2.0V
V_{OL}	Output LOW Voltage	-1830	-1705	-1620		
V_{OHC}	Output HIGH Voltage	-1035			mV	$V_{IN} = V_{IH} (Min)$ or $V_{IL} (Max)$ Loading with 25Ω to -2.0V
V_{OLC}	Output LOW Voltage			-1610		
V_{OLZ}	Cut-Off LOW Voltage			-1950	mV	$V_{IN} = V_{IH} (Min)$ or $V_{IL} (Max)$ $\overline{OEN} = HIGH$
V_{IH}	Input HIGH Voltage	-1165		-870	mV	Guaranteed HIGH Signal for All Inputs
V_{IL}	Input LOW Voltage	-1830		-1475	mV	Guaranteed LOW Signal for All Inputs
I_{IL}	Input LOW Current	0.50			μA	$V_{IN} = V_{IL} (Min)$
I_{IH}	Input HIGH Current			240	μA	$V_{IN} = V_{IH} (Max)$
I_{EE}	Power Supply Current	-138 -143		-70 -70	mA	Inputs Open $V_{EE} = -4.2V$ to $-4.8V$ $V_{EE} = -4.2V$ to $-5.7V$

Note 3: The specified limits represent the "worst case" value for the parameter. Since these values normally occur at the temperature extremes, additional noise immunity and guardbanding can be achieved by decreasing the allowable system operating ranges. Conditions for testing shown in the tables are chosen to guarantee operation under "worst case" conditions.

DIP AC Electrical Characteristics

$V_{EE} = -4.2V$ to $-5.7V$, $V_{CC} = V_{CCA} = GND$

Symbol	Parameter	$T_C = 0^\circ C$		$T_C = +25^\circ C$		$T_C = +85^\circ C$		Units	Conditions
		Min	Max	Min	Max	Min	Max		
t_{PLH}	Propagation Delay Dn to Output	0.70	2.00	0.70	2.00	0.70	2.20	ns	Figures 1, 2 (Note 4)
t_{PZH}	Propagation Delay \overline{OEN} to Output	1.60	4.20	1.60	4.20	1.60	4.20	ns	Figures 1, 2 (Note 4)
t_{TLH}	Transition Time 20% to 80%, 80% to 20%	0.45	2.00	0.45	2.00	0.45	2.00	ns	Figures 1, 2

Note 4: The propagation delay specified is for single output switching. Delays may vary up to 300 ps with multiple outputs switching.

Commercial Version (Continued) PLCC AC Electrical Characteristics

$V_{EE} = 4.2V$ to $-5.7V$, $V_{CC} = V_{CCA} = GND$

Symbol	Parameter	$T_C = 0^\circ C$		$T_C = +25^\circ C$		$T_C = +85^\circ C$		Units	Conditions
		Min	Max	Min	Max	Min	Max		
t_{PLH} t_{PHL}	Propagation Delay Dn to Output	0.70	1.80	0.70	1.80	0.70	2.00	ns	Figures 1, 2 (Note 5)
t_{PZH} t_{PHZ}	Propagation Delay OEN to Output	1.60	4.00	1.60	4.00	1.60	4.00	ns	Figures 1, 2 (Note 5)
t_{TLH} t_{THL}	Transition Time 20% to 80%, 80% to 20%	0.45	1.90	0.45	1.90	0.45	1.90	ns	Figures 1, 2
t_{OSHL}	Maximum Skew Common Edge Output-to-Output Variation Data to Output Path		230		230		230	ps	PLCC only (Note 6)
t_{OSLH}	Maximum Skew Common Edge Output-to-Output Variation Data to Output Path		240		240		240	ps	PLCC only (Note 6)
t_{OST}	Maximum Skew Opposite Edge Output-to-Output Variation Data to Output Path		350		350		350	ps	PLCC only (Note 6)
t_{PS}	Maximum Skew Pin (Signal) Transition Variation Data to Output Path		350		350		350	ps	PLCC only (Note 6)

Note 5: The propagation delay specified is for single output switching. Delays may vary up to 300 ps with multiple outputs switching.

Note 6: Output-to-Output Skew is defined as the absolute value of the difference between the actual propagation delay for any outputs within the same packaged device. The specifications apply to any outputs switching in the same direction either HIGH-to-LOW (t_{OSHL}), or LOW-to-HIGH (t_{OSLH}), or in opposite directions both HL and LH (t_{OST}). Parameters t_{OST} and t_{PS} guaranteed by design.

Industrial Version**PLCC DC Electrical Characteristics** (Note 7)
 $V_{EE} = -4.2V$ to $-5.7V$, $V_{CC} = V_{CCA} = GND$, $T_C = -40^{\circ}C$ to $+85^{\circ}C$

Symbol	Parameter	$T_C = -40^{\circ}C$		$T_C = 0^{\circ}C$ to $+85^{\circ}C$		Units	Conditions
		Min	Max	Min	Max		
V_{OH}	Output HIGH Voltage	-1085	-870	-1025	-870	mV	$V_{IN} = V_{IH(Max)}$ or $V_{IL(Min)}$
V_{OL}	Output LOW Voltage	-1830	-1575	-1830	-1620		
V_{OHC}	Output HIGH Voltage	-1095		-1035		mV	$V_{IN} = V_{IH(Min)}$ or $V_{IL(Max)}$
V_{OLC}	Output LOW Voltage		-1565		-1610		
V_{OLZ}	Cut-Off LOW Voltage		-1950		-1950	mV	$V_{IN} = V_{IH(Min)}$ or $V_{IL(Max)}$ OEN = HIGH
V_{IH}	Input HIGH Voltage	-1170	-870	-1165	-870	mV	Guaranteed HIGH Signal for All Inputs
V_{IL}	Input LOW Voltage	-1830	-1480	-1830	-1475	mV	Guaranteed LOW Signal for All Inputs
I_{IL}	Input LOW Current	0.50		0.50		μA	$V_{IN} = V_{IL(Min)}$
I_{IH}	Input HIGH Current		340		240	μA	$V_{IN} = V_{IH(Max)}$
I_{EE}	Power Supply Current	-138 -143	-60 -60	-138 -143	-70 -70	mA	Inputs OPEN $V_{EE} = -4.2V$ to $-4.8V$ $V_{EE} = -4.2V$ to $-5.7V$

Note 7: The specified limits represent the "worst case" value for the parameter. Since these values normally occur at the temperature extremes, additional noise immunity and guardbanding can be achieved by decreasing the allowable system operating ranges. Conditions for testing shown in the tables are chosen to guarantee operation under "worst case" conditions.

PLCC AC Electrical Characteristics
 $V_{EE} = 4.2V$ to $-5.7V$, $V_{CC} = V_{CCA} = GND$

Symbol	Parameter	$T_C = -40^{\circ}C$		$T_C = +25^{\circ}C$		$T_C = +85^{\circ}C$		Units	Conditions
		Min	Max	Min	Max	Min	Max		
t_{PLH}	Propagation Delay	0.60	1.80	0.70	1.80	0.70	2.00	ns	Figures 1, 2 (Note 8)
t_{PHL}	Dn to Output								
t_{PZH}	Propagation Delay	1.40	4.40	1.60	4.00	1.60	4.00	ns	Figures 1, 2 (Note 8)
t_{PHZ}	OEN to Output								
t_{TLH}	Transition Time	0.40	2.50	0.45	1.90	0.45	1.90	ns	Figures 1, 2
t_{THL}	20% to 80%, 80% to 20%								

Note 8: The propagation delay specified is for single output switching. Delays may vary up to 300 ps with multiple outputs switching.

Test Circuitry

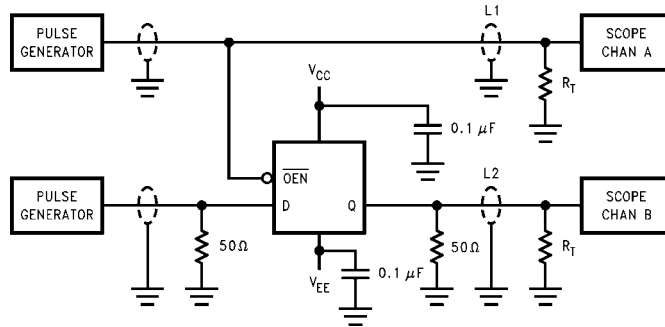

Notes:

$V_{CC}, V_{CCA} = +2V, V_{EE} = -2.5V$

L1 and L2 = equal length 50Ω impedance lines

$R_T = 50\Omega$ terminator internal to scope

Decoupling 0.1 μF from GND to V_{CC} and V_{EE}

All unused outputs are loaded with 25Ω to GND

C_L = Fixture and stray capacitance ≤ 3 pF

FIGURE 1. AC Test Circuit

Switching Waveforms

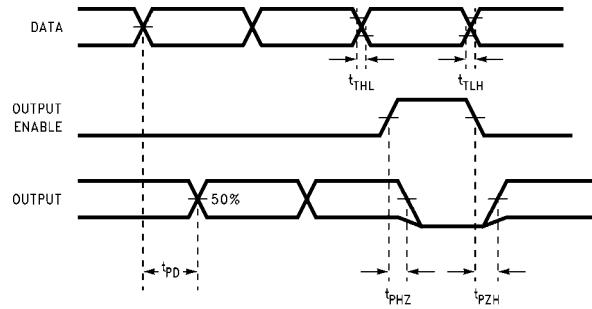

Note:

The output AC measurement point for cut-off propagation delay testing = the 50% voltage point between active V_{OL} and V_{OH} .

FIGURE 2. Propagation Delay, Cut-Off and Transition Times

Physical Dimensions inches (millimeters) unless otherwise noted

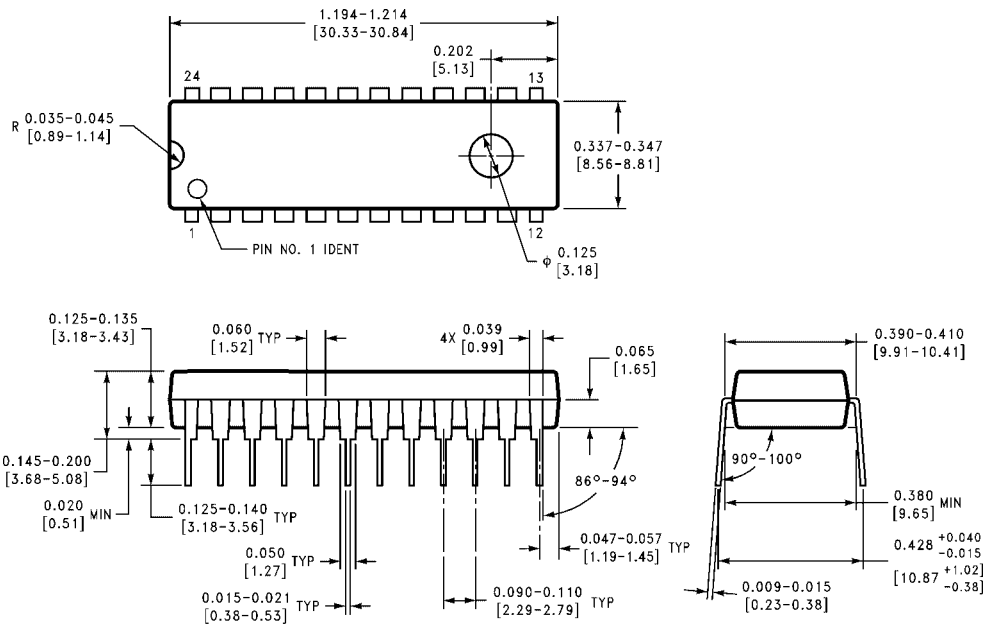

**24-Lead Plastic Dual-In-Line Package (PDIP), JEDEC MS-010, 0.400 Wide
Package Number N24E**

N24E (REV A)

Physical Dimensions inches (millimeters) unless otherwise noted (Continued)

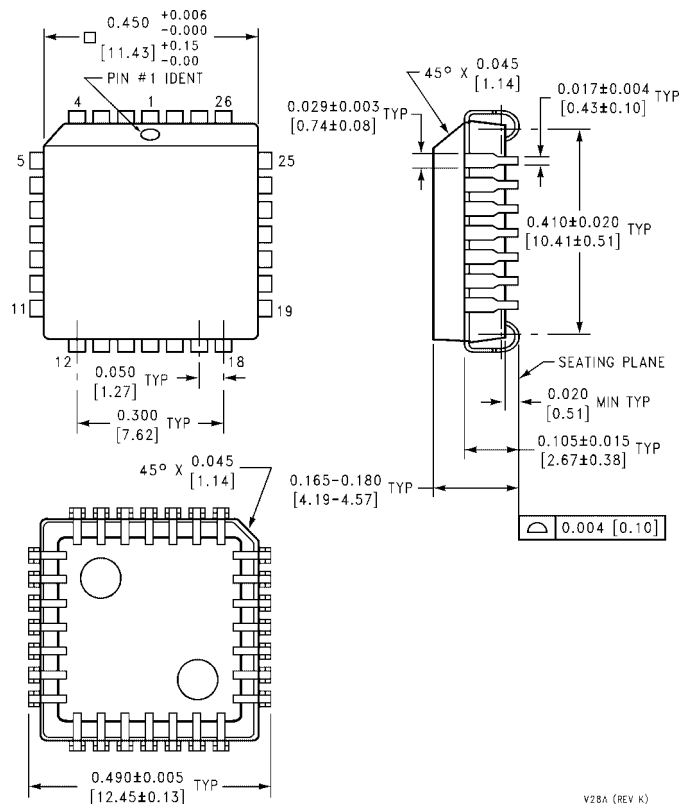

28-Lead Plastic Lead Chip Carrier (PLCC), JEDEC MO-047, 0.450 Square Package Number V28A

Fairchild does not assume any responsibility for use of any circuitry described, no circuit patent licenses are implied and Fairchild reserves the right at any time without notice to change said circuitry and specifications.

LIFE SUPPORT POLICY

FAIRCHILD'S PRODUCTS ARE NOT AUTHORIZED FOR USE AS CRITICAL COMPONENTS IN LIFE SUPPORT DEVICES OR SYSTEMS WITHOUT THE EXPRESS WRITTEN APPROVAL OF THE PRESIDENT OF FAIRCHILD SEMICONDUCTOR CORPORATION. As used herein:

1. Life support devices or systems are devices or systems which, (a) are intended for surgical implant into the body, or (b) support or sustain life, and (c) whose failure to perform when properly used in accordance with instructions for use provided in the labeling, can be reasonably expected to result in a significant injury to the user.
2. A critical component in any component of a life support device or system whose failure to perform can be reasonably expected to cause the failure of the life support device or system, or to affect its safety or effectiveness.

www.fairchildsemi.com

This datasheet has been downloaded from:

www.DatasheetCatalog.com

Datasheets for electronic components.



LittleDiode supplies new, hard to find or obsolete electronic components and semiconductors all over the world.

With over two million different components listed you are sure to find the part you need.

Feel free to visit us today at our online store:

LittleDiode.com

Looking forward to providing you with the best possible service.