

DESCRIPTION

2SC3404 is a silicon NPN epitaxial planar type transistor specifically designed for VHF power amplifier applications.

FEATURES

- High power gain: $G_{pe} \geq 12.7\text{dB}$.
@ $V_{CC} = 7.2\text{V}$, $f = 175\text{MHz}$, $P_{in} = 80\text{mW}$.
- Emitter ballasted construction.
- High ruggedness: Ability to withstand more than 20:1 load VSWR when operated at $V_{CC} = 9\text{V}$, $f = 175\text{MHz}$, $P_o = 1.5\text{W}$, $T_c = 25^\circ\text{C}$.
- Flange type ceramic package.

APPLICATION

For output stage of 1W power amplifiers in VHF band portable type radio sets.

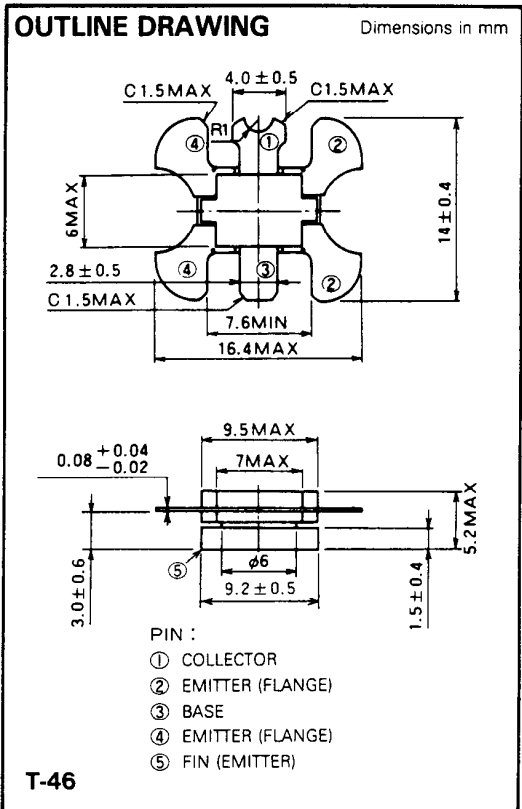

ABSOLUTE MAXIMUM RATINGS ($T_c = 25^\circ\text{C}$)

Symbol	Parameter	Conditions	Ratings	Unit
V_{CBO}	Collector to base voltage		20	V
V_{EBO}	Emitter to base voltage		3.5	V
V_{CEO}	Collector to emitter voltage	$R_{BE} = \infty$	9	V
I_C	Collector current		1	A
P_C	Collector dissipation	$T_c = 25^\circ\text{C}$	5	W
T_j	Junction temperature		175	$^\circ\text{C}$
T_{stg}	Storage temperature		-55 to 175	$^\circ\text{C}$

Note. Above parameters are guaranteed independently.

ELECTRICAL CHARACTERISTICS ($T_c = 25^\circ\text{C}$)

Symbol	Parameter	Test conditions	Limits			Unit
			Min	Typ	Max	
$V_{(BR)EBO}$	Emitter to base breakdown voltage	$I_E = 1\text{mA}$, $I_C = 0$	3.5			V
$V_{(BR)CBO}$	Collector to base breakdown voltage	$I_C = 10\text{mA}$, $I_E = 0$	20			V
$V_{(BR)CEO}$	Collector to emitter breakdown voltage	$I_C = 10\text{mA}$, $R_{BE} = \infty$	9			V
I_{CBO}	Collector cut off current	$V_{CB} = 10\text{V}$, $I_E = 0$			200	μA
I_{EBO}	Emitter cut off current	$V_{EB} = 2\text{V}$, $I_C = 0$			200	μA
h_{FE}	DC forward current gain *	$V_{CE} = 5\text{V}$, $I_C = 0.1\text{A}$	10	50	180	-
P_o	Power Output	$V_{CC} = 7.2\text{V}$, $P_{in} = 80\text{mW}$, $f = 175\text{MHz}$	1.5	1.7		W
η_C	Collector efficiency		55	60		%

Note. * Pulse test, $P_W = 150\mu\text{s}$, duty = 5%.

Above parameters, ratings, limits and conditions are subject to change.

MITSUBISHI RF POWER TRANSISTOR 2SC3404

NPN EPITAXIAL PLANAR TYPE

TEST CIRCUIT (f = 175MHz)

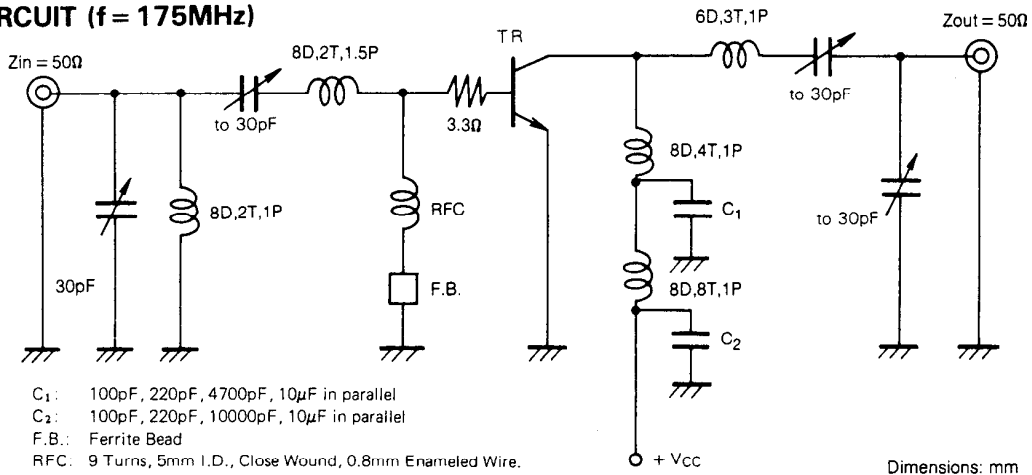

- C_1 : 100pF, 220pF, 4700pF, 10 μ F in parallel
 C_2 : 100pF, 220pF, 10000pF, 10 μ F in parallel
 F.B.: Ferrite Bead
 RFC: 9 Turns, 5mm I.D., Close Wound, 0.8mm Enameled Wire.
 Note: 1.5mm ϕ . Silvered Wire without FRC.
 D: Inner diameter of coil, T: Turn number of coil, P: Pitch of coil

TYPICAL PERFORMANCE DATA

COLLECTOR POWER DISSIPATION VS. CASE TEMPERATURE

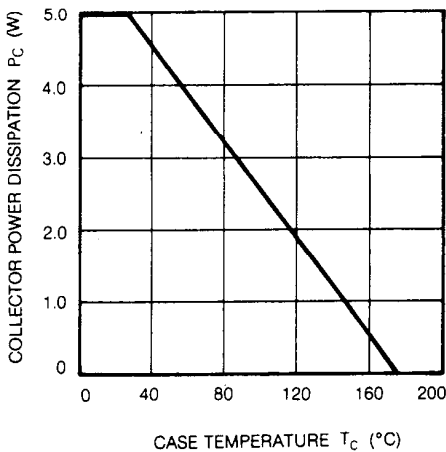

COLLECTOR OUTPUT CAPACITANCE VS. COLLECTOR TO BASE VOLTAGE

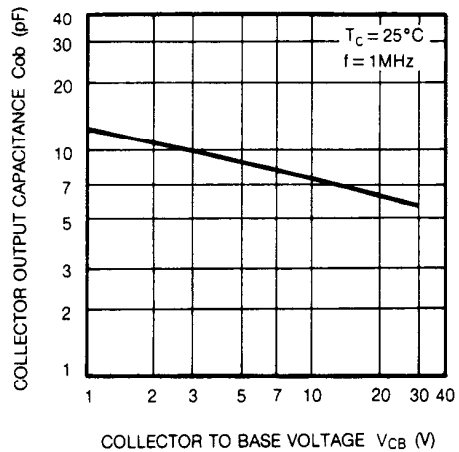

OUTPUT POWER, COLLECTOR EFFICIENCY VS. INPUT POWER

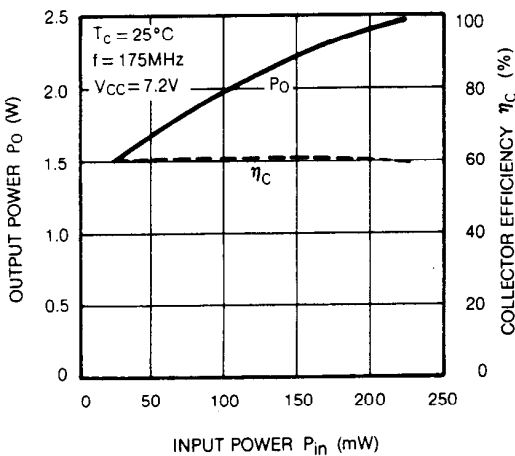

OUTPUT POWER VS. COLLECTOR SUPPLY VOLTAGE

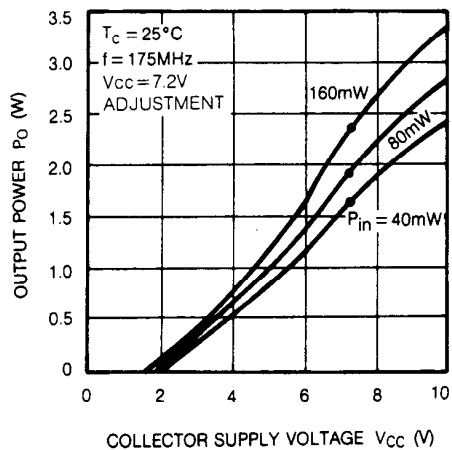

OUTPUT POWER VS. FREQUENCY

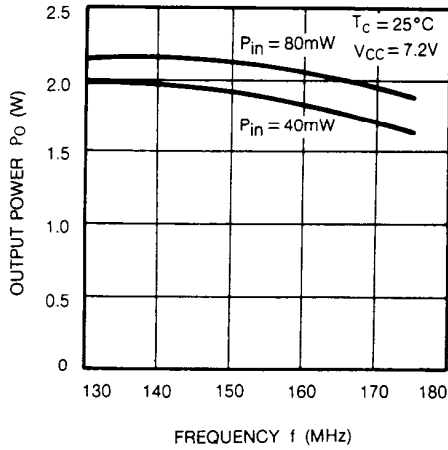

INPUT/OUTPUT IMPEDANCE VS. FREQUENCY

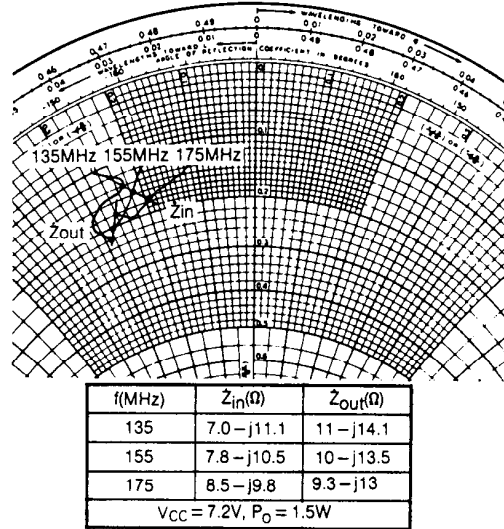

PRECAUTIONS FOR MOUNTING HIGH-FREQUENCY HIGH-OUTPUT TRANSISTOR FOR MOBILE RADIO EQUIPMENT

When mounting high-frequency, high-output transistors for mobile radio equipment (flange screw fastening part cut package), care should be taken to the following points.

1. When mounting the device to the heat sink, silicon compound should be applied to the heat sink and device heat radiating fin and apply the device to the heat sink using a proper fastening tool.
2. If the device is soldered directly to heat sink, excessive thermal stress will result in deteriorating the reliability. Do not use this mounting method.
3. Care should be taken, if the device is applied to the heat sink, the force of soldering the leads to the printed circuit board results in continual mechanical stress, deteriorating the reliability and performance of the system.
4. Refer to Mitsubishi's DATABOOK or manuals for transistors, small-signal diodes and integrated circuit modules for mounting and handling of the device.



LittleDiode supplies new, hard to find or obsolete electronic components and semiconductors all over the world.

With over two million different components listed you are sure to find the part you need.

Feel free to visit us today at our online store:

LittleDiode.com

Looking forward to providing you with the best possible service.