

## 74FCT534 Octal D Flip-Flop with TRI-STATE® Outputs

### General Description

The 'FCT534 is a high-speed, low-power octal D-type flip-flop featuring separate D-type inputs for each flip-flop and TRI-STATE outputs for bus-oriented applications. A buffered Clock (CP) and Output Enable ( $\overline{OE}$ ) are common to all flip-flops. FACT™ FCT utilizes NSC quiet series technology to provide improved quiet output switching and dynamic threshold performance.

FACT FCT features GTO™ output control and undershoot corrector in addition to a split ground bus for superior performance. The 'FCT534 is the same as the 'FCT374 except that the outputs are inverted.

### Features

- $I_{CC}$  and  $I_{OZ}$  reduced to 40.0  $\mu A$  and  $\pm 2.5 \mu A$  respectively
- NSC 54/74FCT534 is pin and functionally equivalent to IDT 54/74FCT534
- Edge-triggered D-type inputs
- Buffered positive edge-triggered clock
- Input clamp diodes to limit bus reflections
- TTL/CMOS input and output level compatible
- $I_{OL} = 48 \text{ mA}$
- CMOS power levels
- ESD immunity  $\geq 4 \text{ kV typ}$

### Logic Symbols

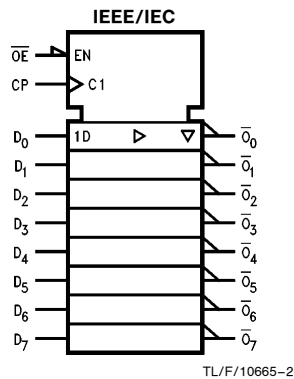
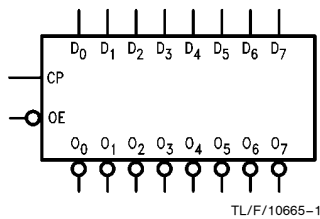

### Connection Diagram

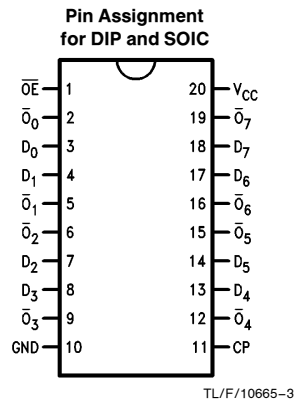

Pin Names	Description
$D_0$ - $D_7$	Data Inputs
CP	Clock Pulse Input
$\overline{OE}$	TRI-STATE Output Enable Input
$\overline{Q}_0$ - $\overline{Q}_7$	Complementary TRI-STATE Outputs

TRI-STATE® is a registered trademark of National Semiconductor Corporation.  
FACT™ and GTO™ are trademarks of National Semiconductor Corporation.

## Functional Description

The 'FCT534 consists of eight edge-triggered flip-flops with individual D-type inputs and TRI-STATE complementary outputs. The buffered clock and buffered Output Enable are common to all flip-flops. The eight flip-flops will store the state of their individual D inputs that meet the setup and hold times requirements on the LOW-to-HIGH Clock (CP)

transition. With the Output Enable ( $\overline{OE}$ ) LOW, the contents of the eight flip-flops are available at the outputs. When the  $\overline{OE}$  is HIGH, the outputs go to the high impedance state. Operation of the  $\overline{OE}$  input does not affect the state of the flip-flops.

## Logic Diagram

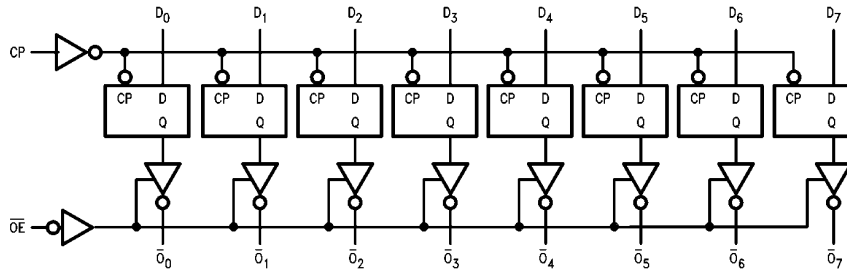

TL/F/10665-5

Please note that this diagram is provided only for the understanding of logic operations and should not be used to estimate propagation delays.

Function Table

Inputs			Output
CP	OE	D	$\overline{O}$
	L	H	L
	L	L	H
L	L	X	$\overline{O}_0$
X	H	X	Z

H = HIGH Voltage Level

L = LOW Voltage Level

X = Immaterial

= LOW-to-HIGH Clock Transition

Z = High Impedance

$\overline{O}_0$  = Value stored from previous clock cycle

## Absolute Maximum Ratings (Note 1)

If Military/Aerospace specified devices are required, please contact the National Semiconductor Sales Office/Distributors for availability and specifications.

Terminal Voltage with Respect to GND ( $V_{TERM}$ )	74FCT	-0.5V to +7.0V
Temperature Under Bias ( $T_{BIAS}$ )	74FCT	-55°C to +125°C
Storage Temperature ( $T_{STG}$ )	74FCT	-55°C to +125°C
DC Output Current ( $I_{OUT}$ )		120 mA

**Note 1:** Absolute maximum ratings are those values beyond which damage to the device may occur. Exposure to absolute maximum rating conditions for extended periods may affect reliability. The databook specifications should be met, without exception, to ensure that the system design is reliable over its power supply, temperature, and output/input loading variables.

## Recommended Operating Conditions

Supply Voltage ( $V_{CC}$ )	74FCT	4.75V to 5.25V
Input Voltage		0V to $V_{CC}$
Output Voltage		0V to $V_{CC}$
Operating Temperature ( $T_A$ )	74FCT	-0°C to +70°C
Junction Temperature ( $T_J$ )	PDIP	140°C

**Note:** All commercial packaging is not recommended for applications requiring greater than 2000 temperature cycles from -40°C to +125°C.

## DC Characteristics for 'FCTA Family Devices

Typical values are at  $V_{CC} = 5.0V$ , 25°C ambient and maximum loading. For test conditions shown as Max, use the value specified for the appropriate device type: Com:  $V_{CC} = 5.0V \pm 5\%$ ,  $T_A = 0^\circ C$  to  $+70^\circ C$ ;  $V_{HC} = V_{CC} - 0.2V$ .

Symbol	Parameter	74FCTA			Units	Conditions	
		Min	Typ	Max			
$V_{IH}$	Minimum High Level Input Voltage	2.0			V		
$V_{IL}$	Maximum Low Level Input Voltage			0.8	V		
$I_{IH}$	Input High Current			5.0 5.0	$\mu A$	$V_{CC} = \text{Max}$	$V_I = V_{CC}$ $V_I = 2.7V$ (Note 2)
$I_{IL}$	Input Low Current			-5.0 -5.0	$\mu A$	$V_{CC} = \text{Max}$	$V_I = 0.5V$ (Note 2) $V_I = \text{GND}$
$I_{OZ}$	Maximum TRI-STATE Current			2.5 2.5 -2.5 -2.5	$\mu A$	$V_{CC} = \text{Max}$	$V_O = V_{CC}$ $V_O = 2.7V$ (Note 2) $V_O = 0.5V$ (Note 2) $V_O = \text{GND}$
$V_{IK}$	Clamp Diode Voltage			-0.7 -1.2	V	$V_{CC} = \text{Min}; I_N = -18 \text{ mA}$	
$I_{OS}$	Short Circuit Current	-60	-120		mA	$V_{CC} = \text{Max}$ (Note 1); $V_O = \text{GND}$	
$V_{OH}$	Minimum High Level Output Voltage	2.8 $V_{HC}$ 2.4	3.0 $V_{CC}$ 4.3		V	$V_{CC} = 3V; V_{IN} = 0.2V$ or $V_{HC}; I_{OH} = -32 \mu A$	$I_{OH} = -300 \mu A$ $I_{OH} = -15 \text{ mA}$
$V_{OL}$	Maximum Low Level Output Voltage		GND GND 0.3	0.2 0.2 0.5	V	$V_{CC} = 3V; V_{IN} = 0.2V$ or $V_{HC}; I_{OL} = 300 \mu A$	$I_{OL} = 300 \mu A$ $I_{OL} = 48 \text{ mA}$

## DC Characteristics for 'FCT Family Devices (Continued)

Typical values are at  $V_{CC} = 5.0V$ ,  $25^{\circ}C$  ambient and maximum loading. For test conditions shown as Max, use the value specified for the appropriate device type: Com:  $V_{CC} = 5.0V \pm 5\%$ ,  $T_A = 0^{\circ}C$  to  $+70^{\circ}C$ ;  $V_{HC} = V_{CC} - 0.2V$ .

Symbol	Parameter	74FCT			Units	Conditions	
		Min	Typ	Max			
$I_{CC}$	Maximum Quiescent Supply Current		1.0	40.0	$\mu A$	$V_{CC} = \text{Max}$ $V_{IN} \geq V_{HC}$ , $V_{IN} \leq 0.2V$ $f_i = 0$	
$\Delta I_{CC}$	Quiescent Supply Current; TTL Inputs HIGH		0.5	2.0	mA	$V_{CC} = \text{Max}$ $V_{IN} = 3.4V$ (Note 3)	
$I_{CCD}$	Dynamic Power Supply Current (Note 4)		0.15	0.25	mA/MHz	$V_{CC} = \text{Max}$ Outputs Open $\overline{OE} = \text{GND}$ One Input Toggling 50% Duty Cycle	$V_{IN} \geq V_{HC}$ $V_{IN} \leq 0.2V$
$I_C$	Total Power Supply Current (Note 6)		1.5	4.0	mA	$V_{CC} = \text{Max}$ Outputs Open $f_{CP} = 10 \text{ MHz}$ $\overline{OE} = \text{GND}$ $f_i = 5 \text{ MHz}$ One Bit Toggling 50% Duty Cycle	$V_{IN} \geq V_{HC}$ $V_{IN} \leq 0.2V$
			1.8	6.0		$V_{IN} = 3.4V$ $V_{IN} = \text{GND}$	
			3.0	7.8		(Note 5) $V_{CC} = \text{Max}$ Outputs Open $\overline{OE} = \text{GND}$ $f_{CP} = 10 \text{ MHz}$ $f_i = 2.5 \text{ MHz}$ Eight Bits Toggling 50% Duty Cycle	$V_{IN} \geq V_{HC}$ $V_{IN} \leq 0.2V$
			5.0	16.8		$V_{IN} = 3.4V$ $V_{IN} = \text{GND}$	
$V_H$	Input Hysteresis on Clock Only		200		mV		

**Note 1:** Maximum test duration not to exceed one second, not more than one output shorted at one time.

**Note 2:** This parameter guaranteed but not tested.

**Note 3:** Per TTL driven input ( $V_{IN} = 3.4V$ ); all other inputs at  $V_{CC}$  or GND.

**Note 4:** This parameter is not directly testable, but is derived for use in Total Power Supply calculations.

**Note 5:** Values for these conditions are examples of the  $I_{CC}$  formula. These limits are guaranteed but not tested.

**Note 6:**  $I_C = I_{\text{QUIESCENT}} + I_{\text{INPUTS}} + I_{\text{DYNAMIC}}$

$$I_C = I_{CC} + \Delta I_{CC} D_H N_T + I_{CCD} (f_{CP}/2 + f_i N_i)$$

$I_{CC}$  = Quiescent Current

$\Delta I_{CC}$  = Power Supply Current for a TTL High Input ( $V_{IN} = 3.4V$ )

$D_H$  = Duty Cycle for TTL inputs High

$N_T$  = Number of Inputs at  $D_H$

$I_{CCD}$  = Dynamic Current Caused by an Input Transition Pair (HLH or LHL)

$f_{CP}$  = Clock Frequency for Register Devices (Zero for Non-Register Devices)

$f_i$  = Input Frequency

$N_i$  = Numbers of Inputs at  $f_i$

All currents are in milliamps and all frequencies are in megahertz.

## AC Electrical Characteristics

Symbol	Parameter	74FCT	74FCT		Units
		$T_A = +25^\circ\text{C}$ $V_{CC} = 5.0\text{V}$	$T_A, V_{CC} = \text{Com}$ $C_L = 50\text{ pF}$		
		Typ	Min (Note 1)	Max	
$t_{PLH}$ $t_{PHL}$	Propagation Delay C <sub>P</sub> to $\bar{O}_n$	6.5	1.5	10.0	ns
$t_{PZH}$ $t_{PZL}$	Output Enable Time	9.0	1.5	12.5	ns
$t_{PHZ}$ $t_{PLZ}$	Output Disable Time	6.0	1.5	8.0	ns
$t_s$	Set Up Time High or Low D <sub>n</sub> to C <sub>P</sub>	1.0	2.0		ns
$t_h$	Hold Time High or Low D <sub>n</sub> to C <sub>P</sub>	0.5	1.5		ns
$t_w$	CP Pulse Width High or Low	4.0	7.0		ns

**Note 1:** Minimum limits guaranteed but not tested on propagation delays.

### Capacitance $T_A = +25^\circ\text{C}, f_i = 1.0\text{ MHz}$

Symbol	Parameter	Typ	Max	Units	Conditions
$C_{IN}$	Input Capacitance	6	10	pF	$V_{IN} = 0\text{V}$
$C_{OUT}$	Output Capacitance	8	12	pF	$V_{OUT} = 0\text{V}$

**Note:** This parameter is measured at characterization but not tested.  
 $C_{OUT}$  for 74FCT only.

### Ordering Information

The device number is used to form part of a simplified purchasing code where a package type and temperature range are defined as follows:

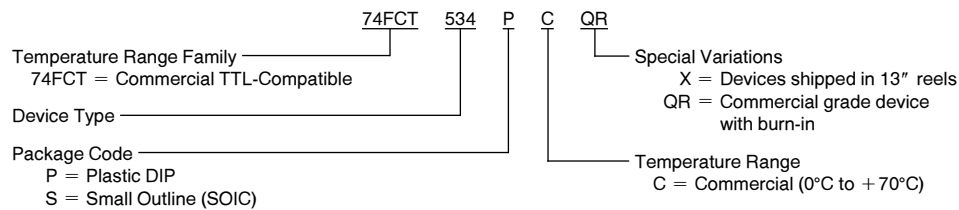



**Physical Dimensions** inches (millimeters)

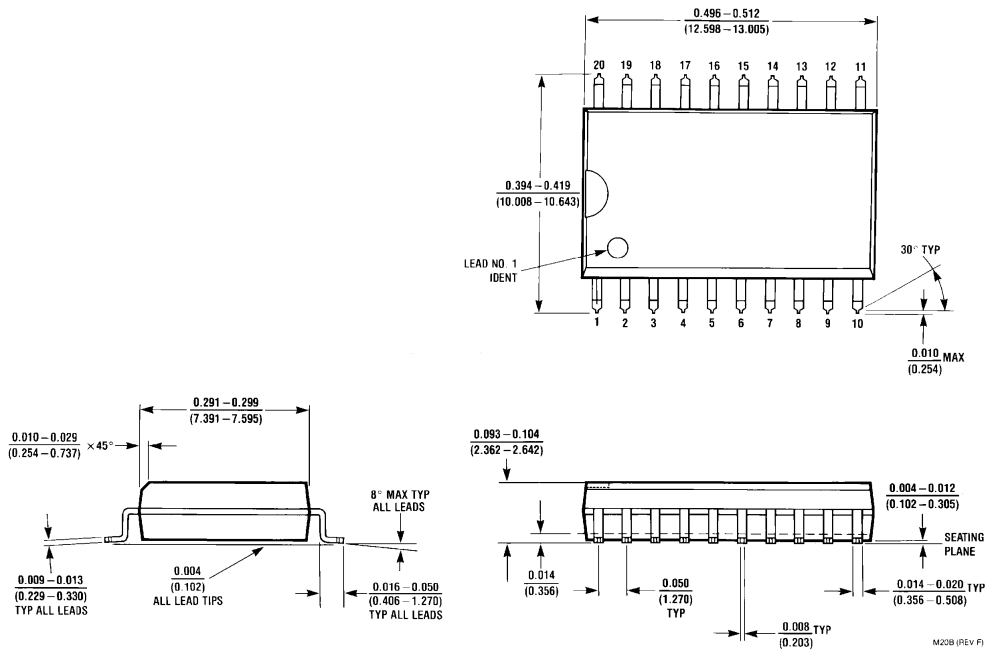

**20-Lead Small Outline Integrated Circuit (S)  
NS Package Number M20B**

M20B (REV. F)

**Physical Dimensions** inches (millimeters) (Continued)

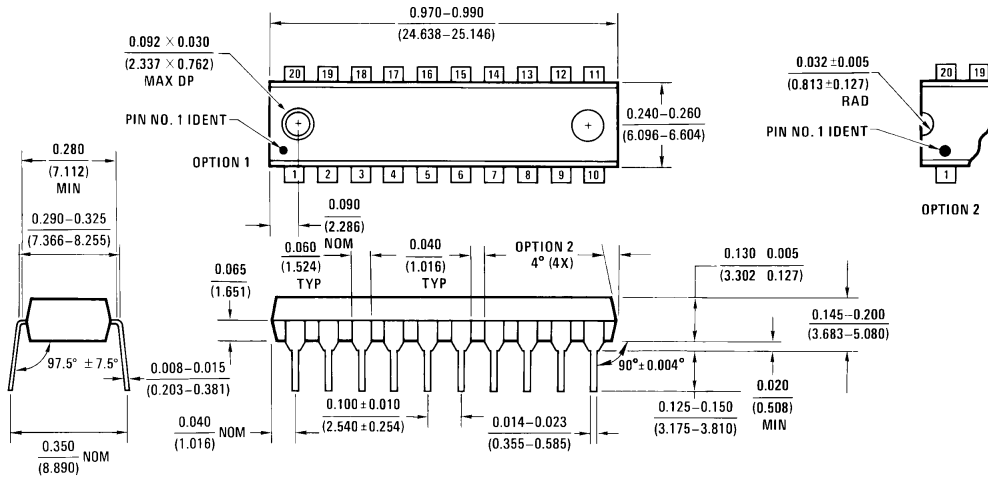

**20-Lead Plastic Dual-In-Line Package (P)**  
**NS Package Number N20B**

N20B (REV A)

**LIFE SUPPORT POLICY**

NATIONAL'S PRODUCTS ARE NOT AUTHORIZED FOR USE AS CRITICAL COMPONENTS IN LIFE SUPPORT DEVICES OR SYSTEMS WITHOUT THE EXPRESS WRITTEN APPROVAL OF THE PRESIDENT OF NATIONAL SEMICONDUCTOR CORPORATION. As used herein:

1. Life support devices or systems are devices or systems which, (a) are intended for surgical implant into the body, or (b) support or sustain life, and whose failure to perform, when properly used in accordance with instructions for use provided in the labeling, can be reasonably expected to result in a significant injury to the user.
2. A critical component is any component of a life support device or system whose failure to perform can be reasonably expected to cause the failure of the life support device or system, or to affect its safety or effectiveness.



**National Semiconductor Corporation**  
1111 West Bardin Road  
Arlington, TX 76017  
Tel: 1(800) 272-9959  
Fax: 1(800) 737-7018

**National Semiconductor Europe**  
Fax: (+49) 0-180-530 85 86  
Email: cnjwge@tevm2.nsc.com  
Deutsch Tel: (+49) 0-180-530 85 85  
English Tel: (+49) 0-180-532 78 32  
Français Tel: (+49) 0-180-532 93 58  
Italiano Tel: (+49) 0-180-534 16 80

**National Semiconductor Hong Kong Ltd.**  
19th Floor, Straight Block,  
Ocean Centre, 5 Canton Rd.  
Tsimshatsui, Kowloon  
Hong Kong  
Tel: (852) 2737-1600  
Fax: (852) 2736-9960

**National Semiconductor Japan Ltd.**  
Tel: 81-043-299-2309  
Fax: 81-043-299-2408

National does not assume any responsibility for use of any circuitry described, no circuit patent licenses are implied and National reserves the right at any time without notice to change said circuitry and specifications.

# National Semiconductor was acquired by Texas Instruments.

[http://www.ti.com/corp/docs/investor\\_relations/pr\\_09\\_23\\_2011\\_national\\_semiconductor.html](http://www.ti.com/corp/docs/investor_relations/pr_09_23_2011_national_semiconductor.html)

This file is the datasheet for the following electronic components:

74FCT534 - <http://www.ti.com/product/74fct534?HQS=TI-null-null-dscatalog-df-pf-null-ww>



LittleDiode supplies new, hard to find or obsolete electronic components and semiconductors all over the world.

With over two million different components listed you are sure to find the part you need.

Feel free to visit us today at our online store:

[LittleDiode.com](http://LittleDiode.com)

Looking forward to providing you with the best possible service.