

74LCX16543

Low Voltage 16-Bit Registered Transceiver with 5V Tolerant Inputs and Outputs

General Description

The LCX16543 contains sixteen non-inverting transceivers containing two sets of D-type registers for temporary storage of data flowing in either direction. Each byte has separate control inputs which can be shorted together for full 16-bit operation. Separate Latch Enable and Output Enable inputs are provided for each register to permit independent input and output control in either direction of data flow.

The LCX16543 is designed for low voltage (2.5V or 3.3V) V_{CC} applications with capability of interfacing to a 5V signal environment.

The LCX16543 is fabricated with an advanced CMOS technology to achieve high speed operation while maintaining CMOS low power dissipation.

Features

- 5V tolerant inputs and outputs
- 2.3V–3.6V V_{CC} specifications provided
- 5.2 ns t_{PD} max ($V_{CC} = 3.3V$), 20 μA I_{CC} max
- Power down high impedance inputs and outputs
- Supports live insertion/withdrawal (Note 1)
- ± 24 mA Output Drive ($V_{CC} = 3.0V$)
- Implements patented noise/EMI reduction circuitry
- Latch-up performance exceeds 500 mA
- ESD performance:
 - Human Body Model > 2000V
 - Machine Model > 200V

Note 1: To ensure the high-impedance state during power up or down, \overline{OE} should be tied to V_{CC} through a pull-up resistor; the minimum value or the resistor is determined by the current-sourcing capability of the driver.

Ordering Code:

Order Number	Package Number	Package Description
74LCX16543MEA	MS56A	56-Lead Shrink Small Outline Package (SSOP), JEDEC MO-118, 0.300 Wide
74LCX16543MTD	MTD56	56-Lead Thin Shrink Small Outline Package (TSSOP), JEDEC MO-153, 6.1mm Wide

Devices also available in Tape and Reel. Specify by appending the suffix letter "X" to the ordering code.

Connection Diagram

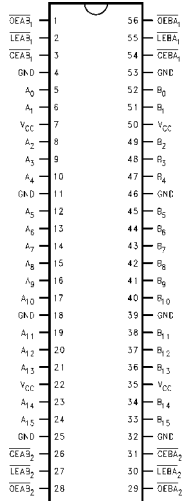

Logic Symbol

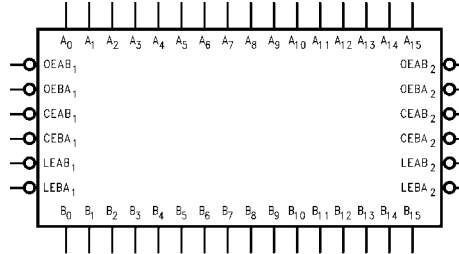

74LCX16543 Low Voltage 16-Bit Registered Transceiver with 5V Tolerant Inputs and Outputs

Pin Descriptions

Pin Names	Description
\overline{OEAB}_n	A-to-B Output Enable Input (Active LOW)
\overline{OEBA}_n	B-to-A Output Enable Input (Active LOW)
\overline{CEAB}_n	A-to-B Enable Input (Active LOW)
\overline{CEBA}_n	B-to-A Enable Input (Active LOW)
\overline{LEAB}_n	A-to-B Latch Enable Input (Active LOW)
\overline{LEBA}_n	B-to-A Latch Enable Input (Active LOW)
A_0-A_{15}	A-to-B Data Inputs or B-to-A 3-STATE Outputs
B_0-B_{15}	B-to-A Data Inputs or A-to-B 3-STATE Outputs

Data I/O Control Table

Inputs			Latch Status	Output Buffers
\overline{CEAB}_n	\overline{LEAB}_n	\overline{OEAB}_n	(Byte n)	(Byte n)
H	X	X	Latched	High Z
X	H	X	Latched	—
L	L	X	Transparent	—
X	X	H	—	High Z
L	X	L	—	Driving

H = HIGH Voltage Level

L = LOW Voltage Level

X = Immaterial

A-to-B data flow shown; B-to-A flow control is the same, except using \overline{CEBA}_n , \overline{LEBA}_n and \overline{OEBA}_n

Functional Description

The LCX16543 contains sixteen non-inverting transceivers with 3-STATE outputs. The device is byte controlled with each byte functioning identically, but independent of the other. The control pins may be shorted together to obtain full 16-bit operation. The following description applies to each byte. For data flow from A to B, for example, the A-to-B Enable (\overline{CEAB}_n) input must be LOW in order to enter data from A_0-A_{15} or take data from B_0-B_{15} , as indicated in the Data I/O Control Table. With \overline{CEAB}_n LOW, a LOW signal on the A-to-B Latch Enable (\overline{LEAB}_n) input

makes the A-to-B latches transparent; a subsequent LOW-to-HIGH transition of the \overline{LEAB}_n signal puts the A latches in the storage mode and their outputs no longer change with the A inputs. With \overline{CEAB}_n and \overline{OEAB}_n both LOW, the 3-STATE B output buffers are active and reflect the data present at the output of the A latches. Control of data flow from B to A is similar, but using the \overline{CEBA}_n , \overline{LEBA}_n and \overline{OEBA}_n inputs.

Logic Diagrams

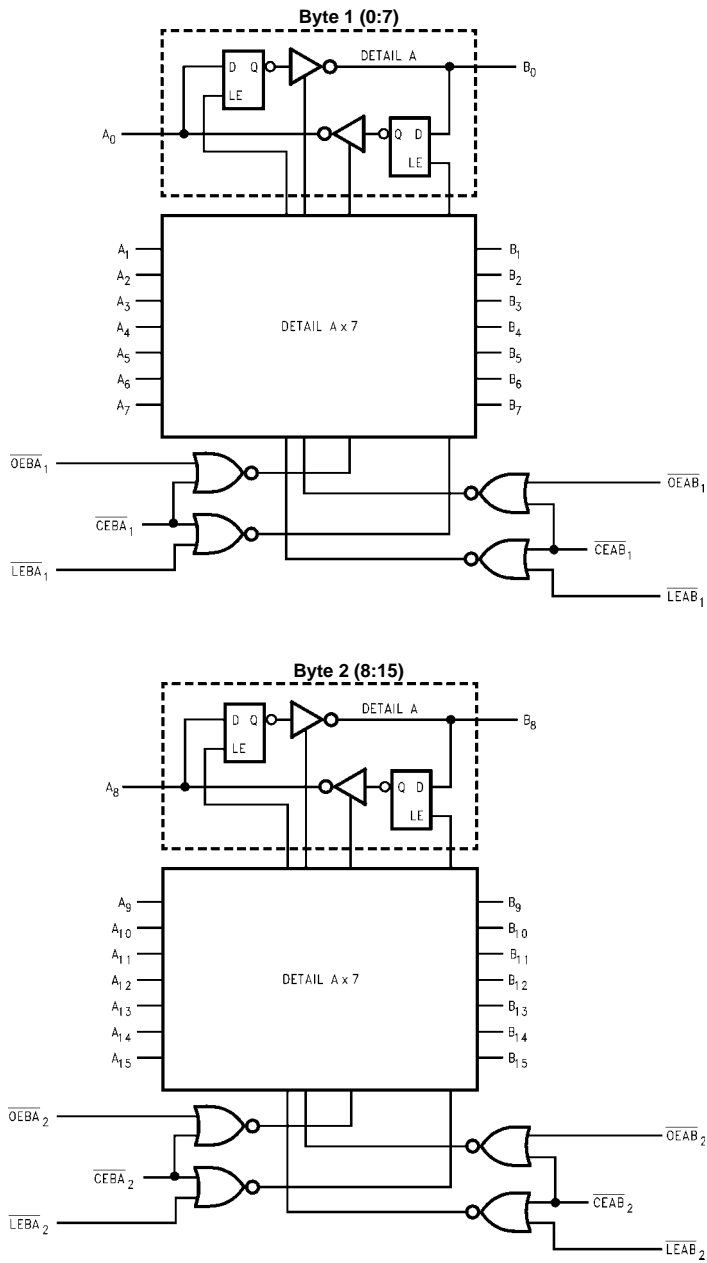

Please note that these diagrams are provided only for the understanding of logic operations and should not be used to estimate propagation delays.

Absolute Maximum Ratings (Note 2)						
Symbol	Parameter	Value	Conditions	Units		
V_{CC}	Supply Voltage	-0.5 to +7.0		V		
V_I	DC Input Voltage	-0.5 to +7.0		V		
V_O	DC Output Voltage	-0.5 to +7.0 -0.5 to $V_{CC} + 0.5$	Output in 3-STATE Output in HIGH or LOW State (Note 3)	V		
I_{IK}	DC Input Diode Current	-50	$V_I < \text{GND}$	mA		
I_{OK}	DC Output Diode Current	-50 +50	$V_O < \text{GND}$ $V_O > V_{CC}$	mA		
I_O	DC Output Source/Sink Current	± 50		mA		
I_{CC}	DC Supply Current per Supply Pin	± 100		mA		
I_{GND}	DC Ground Current per Ground Pin	± 100		mA		
T_{STG}	Storage Temperature	-65 to +150		°C		
Recommended Operating Conditions (Note 4)						
Symbol	Parameter	Min	Max	Units		
V_{CC}	Supply Voltage	Operating	2.0	3.6	V	
		Data Retention	1.5	3.6		
V_I	Input Voltage	0	5.5	V		
V_O	Output Voltage	HIGH or LOW State	0	V_{CC}	V	
		3-STATE	0	5.5		
I_{OH}/I_{OL}	Output Current	$V_{CC} = 3.0\text{V} - 3.6\text{V}$		± 24	mA	
		$V_{CC} = 2.7\text{V} - 3.0\text{V}$		± 12		
		$V_{CC} = 2.3\text{V} - 2.7\text{V}$		± 8		
T_A	Free-Air Operating Temperature	-40	85	°C		
$\Delta t/\Delta V$	Input Edge Rate, $V_{IN} = 0.8\text{V} - 2.0\text{V}$, $V_{CC} = 3.0\text{V}$	0	10	ns/V		
<p>Note 2: The Absolute Maximum Ratings are those values beyond which the safety of the device cannot be guaranteed. The device should not be operated at these limits. The parametric values defined in the Electrical Characteristics tables are not guaranteed at the Absolute Maximum Ratings. The "Recommended Operating Conditions" table will define the conditions for actual device operation.</p> <p>Note 3: I_O Absolute Maximum Rating must be observed.</p> <p>Note 4: Unused (inputs or I/Os) must be held HIGH or LOW. They may not float.</p>						
DC Electrical Characteristics						
Symbol	Parameter	Conditions	V_{CC} (V)	$T_A = -40^\circ\text{C to } +85^\circ\text{C}$		Units
				Min	Max	
V_{IH}	HIGH Level Input Voltage		2.3 - 2.7	1.7		V
			2.7 - 3.6	2.0		
V_{IL}	LOW Level Input Voltage		2.3 - 2.7		0.7	V
			2.7 - 3.6		0.8	
V_{OH}	HIGH Level Output Voltage	$I_{OH} = -100 \mu\text{A}$	2.3 - 3.6	$V_{CC} - 0.2$		V
			2.3	1.8		
			2.7	2.2		
			3.0	2.4		
			3.0	2.2		
V_{OL}	LOW Level Output Voltage	$I_{OL} = 100 \mu\text{A}$	2.3 - 3.6		0.2	V
			2.3		0.6	
			2.7		0.4	
			3.0		0.4	
			3.0		0.55	
I_I	Input Leakage Current	$0 \leq V_I \leq 5.5\text{V}$	2.3 - 3.6		± 5.0	μA
I_{OZ}	3-STATE I/O Leakage	$0 \leq V_O \leq 5.5\text{V}$ $V_I = V_{IH}$ or V_{IL}	2.3 - 3.6		± 5.0	μA
I_{OFF}	Power-Off Leakage Current	V_I or $V_O = 5.5\text{V}$	0		10	μA

DC Electrical Characteristics (Continued)								
Symbol	Parameter	Conditions	V _{CC} (V)	T _A = -40°C to +85°C		Units		
				Min	Max			
I _{CC}	Quiescent Supply Current	V _I = V _{CC} or GND	2.3 – 3.6		20	μA		
		3.6V ≤ V _I , V _O ≤ 5.5V (Note 5)	2.3 – 3.6		±20			
ΔI _{CC}	Increase in I _{CC} per Input	V _{IH} = V _{CC} - 0.6V	2.3 – 3.6		500	μA		
Note 5: Outputs in disabled or 3-STATE only.								
AC Electrical Characteristics								
Symbol	Parameter	T _A = -40°C to +85°C, R _L = 500 Ω						Units
		V _{CC} = 3.3V ± 0.3V		V _{CC} = 2.7V		V _{CC} = 2.5V ± 0.2V		
		C _L = 50 pF		C _L = 50 pF		C _L = 30 pF		
		Min	Max	Min	Max	Min	Max	
t _{PHL}	Propagation Delay	1.5	5.2	1.5	6.0	1.5	6.2	ns
t _{PLH}	A _n to B _n or B _n to A _n	1.5	5.2	1.5	6.0	1.5	6.2	
t _{PHL}	Propagation Delay	1.5	6.5	1.5	7.5	1.5	7.8	ns
t _{PLH}	LEBA _n to A _n or LEAB _n to B _n	1.5	6.5	1.5	7.5	1.5	7.8	
t _{PZL}	Output Enable Time							ns
t _{PZH}	OEBA _n or OEAB _n to A _n or B _n CEBA _n or CEAB _n to A _n or B _n	1.5	6.5	1.5	7.0	1.5	8.5	
t _{PLZ}	Output Disable Time							ns
t _{PHZ}	OEBA _n or OEAB _n to A _n or B _n CEBA _n or CEAB _n to A _n or B _n	1.5	6.5	1.5	7.0	1.5	7.8	
t _S	Setup Time, HIGH or LOW, Data to LEX _n	2.5		2.5		3.0		ns
t _H	Hold Time, HIGH or LOW, Data to LEX _n	1.5		1.5		2.0		ns
t _W	Pulse Width, Latch Enable, LOW	3.0		3.0		3.5		ns
t _{OSSL}	Output to Output Skew (Note 6)		1.0					ns
t _{OSLH}			1.0					
Note 6: Skew is defined as the absolute value of the difference between the actual propagation delay for any two separate outputs of the same device. The specification applies to any outputs switching in the same direction, either HIGH-to-LOW (t _{OSSL}) or LOW-to-HIGH (t _{OSLH}). Parameter guaranteed by design.								
Dynamic Switching Characteristics								
Symbol	Parameter	Conditions	V _{CC} (V)	T _A = 25°C		Units		
				Typical				
V _{OLP}	Quiet Output Dynamic Peak V _{OL}	C _L = 50 pF, V _{IH} = 3.3V, V _{IL} = 0V	3.3	0.8		V		
		C _L = 30 pF, V _{IH} = 2.5V, V _{IL} = 0V	2.5	0.6				
V _{OLV}	Quiet Output Dynamic Valley V _{OL}	C _L = 50 pF, V _{IH} = 3.3V, V _{IL} = 0V	3.3	-0.8		V		
		C _L = 30 pF, V _{IH} = 2.5V, V _{IL} = 0V	2.5	-0.6				
Capacitance								
Symbol	Parameter	Conditions	Typical	Units				
C _{IN}	Input Capacitance	V _{CC} = Open, V _I = 0V or V _{CC}	7	pF				
C _{I/O}	Input/Output Capacitance	V _{CC} = 3.3V, V _I = 0V or V _{CC}	8	pF				
C _{PD}	Power Dissipation Capacitance	V _{CC} = 3.3V, V _I = 0V or V _{CC} , f = 10 MHz	20	pF				

AC LOADING and WAVEFORMS Generic for LCX Family

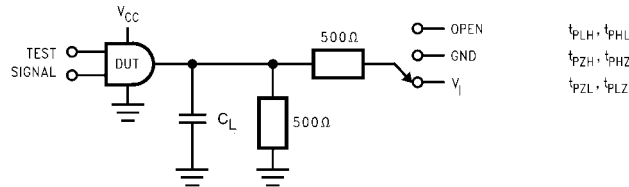
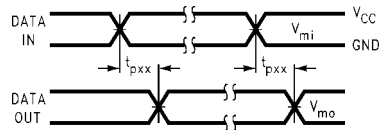
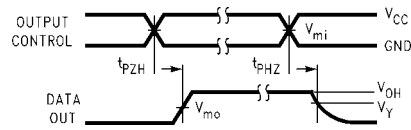

FIGURE 1. AC Test Circuit (C_L includes probe and jig capacitance)

Test	Switch
t_{PLH}, t_{PHL}	Open
t_{PZL}, t_{PLZ}	6V at $V_{CC} = 3.3 \pm 0.3V$ $V_{CC} \times 2$ at $V_{CC} = 2.5 \pm 0.2V$
t_{PZH}, t_{PHZ}	GND



Waveform for Inverting and Non-Inverting Functions



3-STATE Output High Enable and Disable Times for Logic

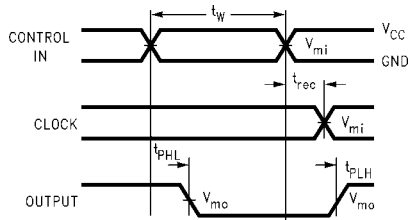

Propagation Delay, Pulse Width and t_{rec} Waveforms

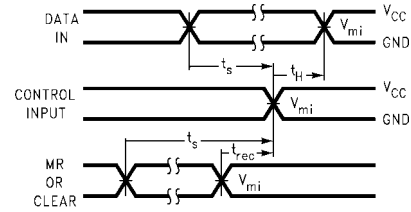

Setup Time, Hold Time and Recovery Time for Logic

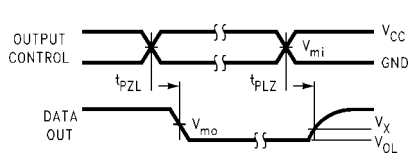

3-STATE Output Low Enable and Disable Times for Logic

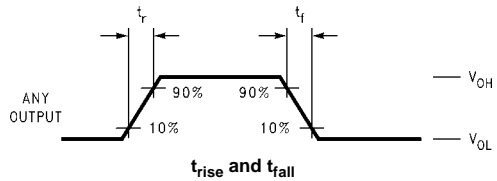
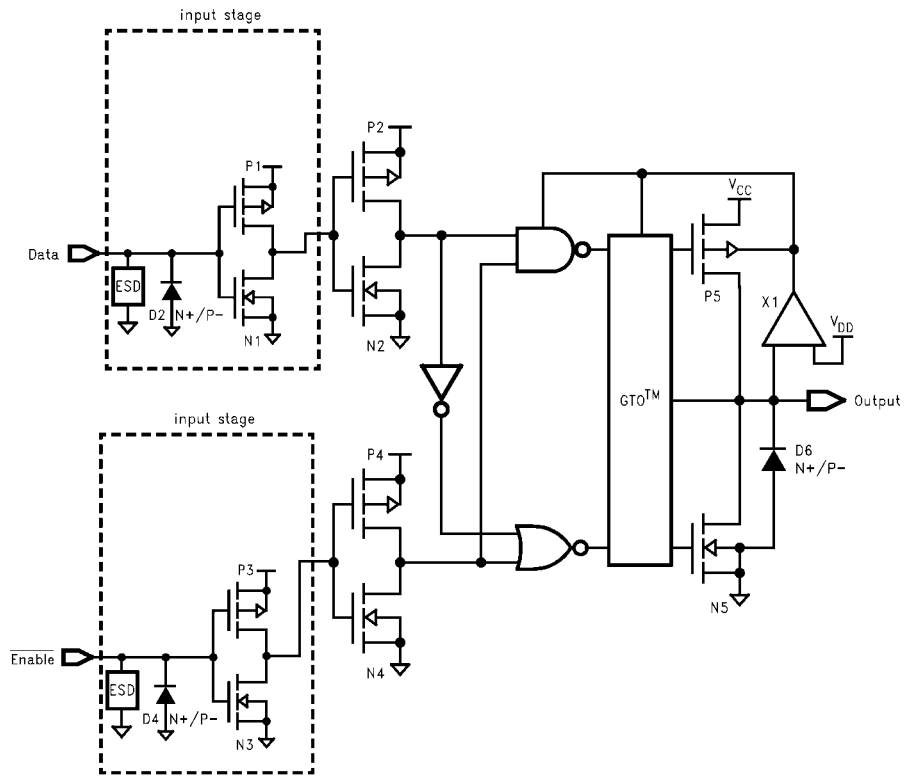

FIGURE 2. Waveforms (Input Characteristics; $f = 1MHz, t_r = t_f = 3ns$)

Symbol	V_{CC}		
	$3.3V \pm 0.3V$	$2.7V$	$2.5V \pm 0.2V$
V_{mi}	1.5V	1.5V	$V_{CC}/2$
V_{mo}	1.5V	1.5V	$V_{CC}/2$
V_x	$V_{OL} + 0.3V$	$V_{OL} + 0.3V$	$V_{OL} + 0.15V$
V_y	$V_{OH} - 0.3V$	$V_{OH} - 0.3V$	$V_{OH} - 0.15V$

Schematic Diagram Generic for LCX Family



74LCX16543

Physical Dimensions inches (millimeters) unless otherwise noted

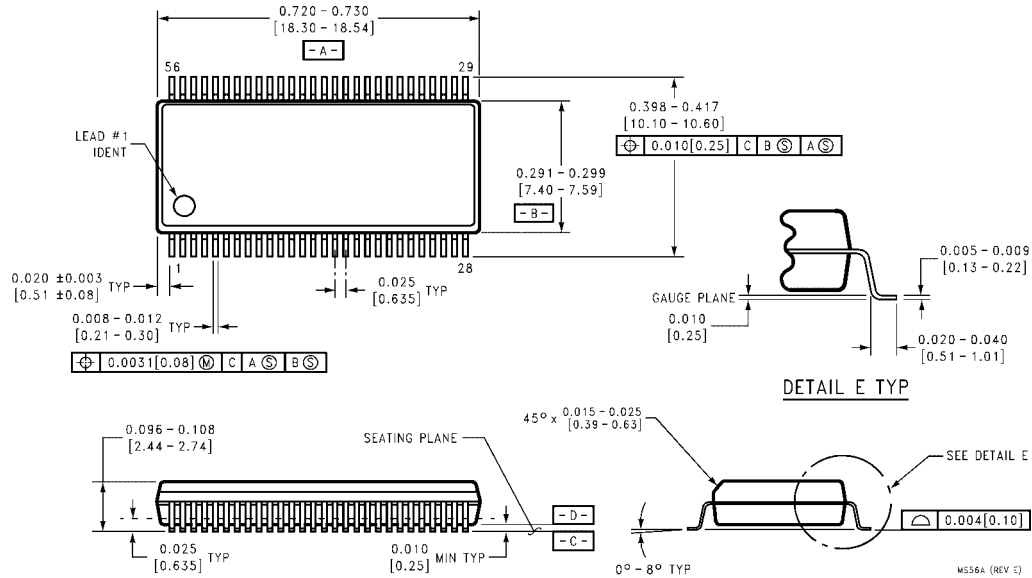

**56-Lead Shrink Small Outline Package (SSOP), JEDEC MO-118, 0.300 Wide
Package Number MS56A**

Physical Dimensions inches (millimeters) unless otherwise noted (Continued)

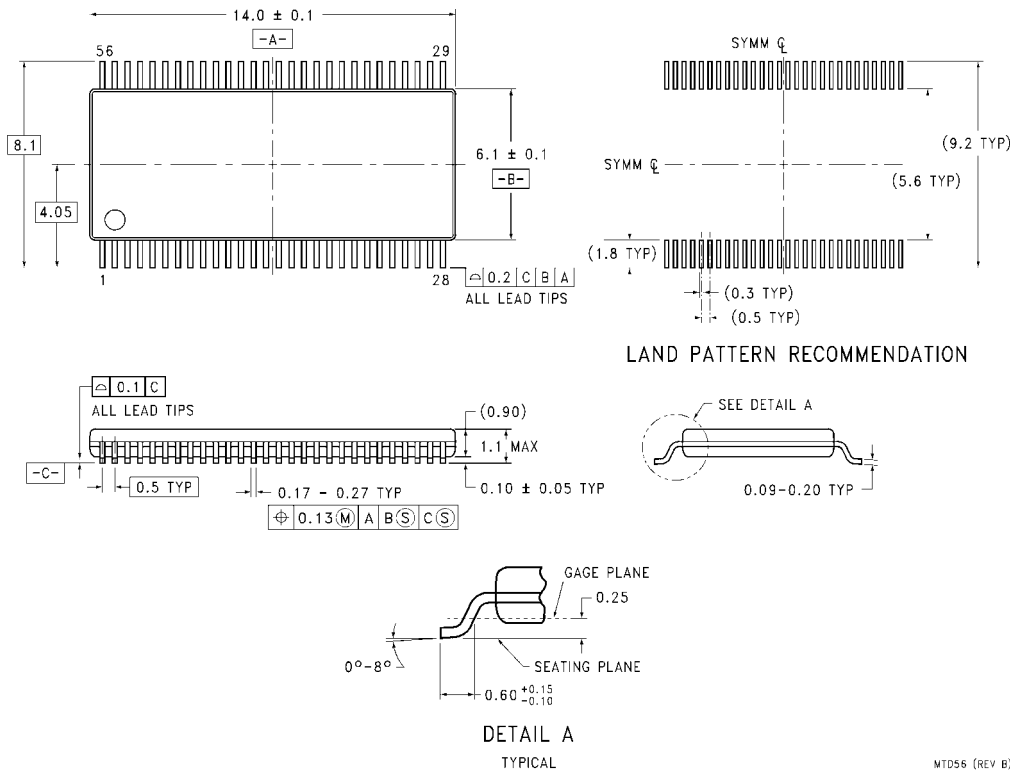

MTD56 (REV. B)

**56-Lead Thin Shrink Small Outline Package (TSSOP), JEDEC MO-153, 6.1mm Wide
Package Number MTD56**

Fairchild does not assume any responsibility for use of any circuitry described, no circuit patent licenses are implied and Fairchild reserves the right at any time without notice to change said circuitry and specifications.

LIFE SUPPORT POLICY

FAIRCHILD'S PRODUCTS ARE NOT AUTHORIZED FOR USE AS CRITICAL COMPONENTS IN LIFE SUPPORT DEVICES OR SYSTEMS WITHOUT THE EXPRESS WRITTEN APPROVAL OF THE PRESIDENT OF FAIRCHILD SEMICONDUCTOR CORPORATION. As used herein:

1. Life support devices or systems are devices or systems which, (a) are intended for surgical implant into the body, or (b) support or sustain life, and (c) whose failure to perform when properly used in accordance with instructions for use provided in the labeling, can be reasonably expected to result in a significant injury to the user.
2. A critical component in any component of a life support device or system whose failure to perform can be reasonably expected to cause the failure of the life support device or system, or to affect its safety or effectiveness.

www.fairchildsemi.com



LittleDiode supplies new, hard to find or obsolete electronic components and semiconductors all over the world.

With over two million different components listed you are sure to find the part you need.

Feel free to visit us today at our online store:

LittleDiode.com

Looking forward to providing you with the best possible service.