

QUAD BUS BUFFERS (3-STATE)

- HIGH SPEED: $t_{PD} = 3.8\text{ns}$ (TYP.) at $V_{CC} = 5\text{V}$
- LOW POWER DISSIPATION:
 $I_{CC} = 4\ \mu\text{A}$ (MAX.) at $T_A = 25^\circ\text{C}$
- HIGH NOISE IMMUNITY:
 $V_{NIH} = V_{NIL} = 28\% V_{CC}$ (MIN.)
- POWER DOWN PROTECTION ON INPUTS
- SYMMETRICAL OUTPUT IMPEDANCE:
 $|I_{OH}| = I_{OL} = 8\ \text{mA}$ (MIN)
- BALANCED PROPAGATION DELAYS:
 $t_{PLH} \cong t_{PHL}$
- OPERATING VOLTAGE RANGE:
 $V_{CC}(\text{OPR}) = 2\text{V to } 5.5\text{V}$
- PIN AND FUNCTION COMPATIBLE WITH 74 SERIES 126
- IMPROVED LATCH-UP IMMUNITY
- LOW NOISE: $V_{OLP} = 0.8\text{V}$ (MAX.)

DESCRIPTION

The 74VHC126 is an advanced high-speed CMOS QUAD BUS BUFFERS fabricated with sub-micron silicon gate and double-layer metal wiring C²MOS technology.

The device requires the 3-STATE control input G to be set low to place the output go in to the high impedance state.

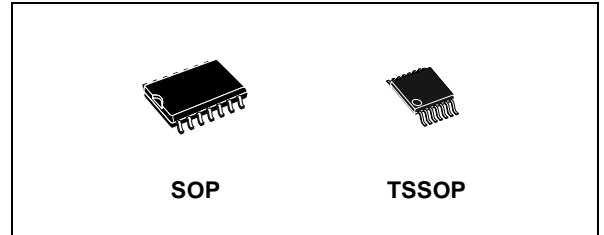

Table 1: Order Codes

PACKAGE	T & R
SOP	74VHC126MTR
TSSOP	74VHC126TTR

Power down protection is provided on all inputs and 0 to 7V can be accepted on inputs with no regard to the supply voltage. This device can be used to interface 5V to 3V.

All inputs and outputs are equipped with protection circuits against static discharge, giving them 2KV ESD immunity and transient excess voltage.

Figure 1: Pin Connection And IEC Logic Symbols

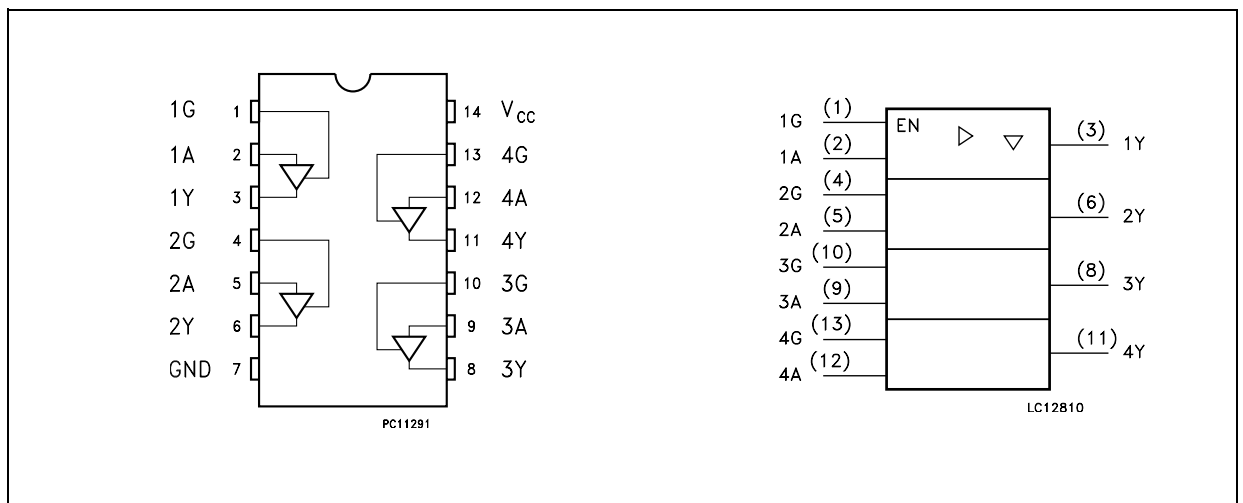

Figure 2: Input Equivalent Circuit

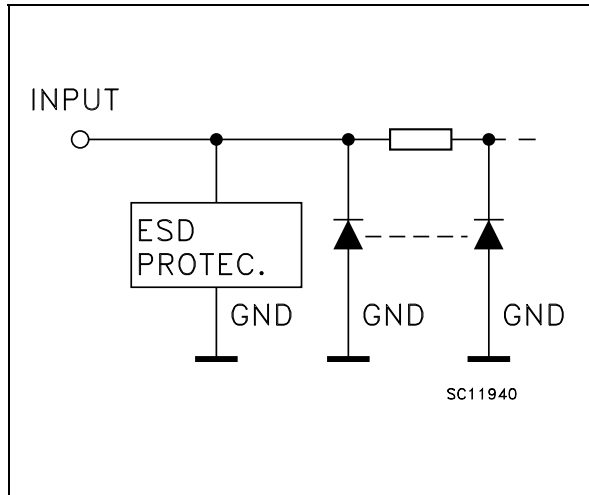

Table 2: Pin Description

PIN N°	SYMBOL	NAME AND FUNCTION
1, 4, 10, 13	1G to 4G	Output Enable Inputs
2, 5, 9, 12	1A to 4A	Data Inputs
3, 6, 8, 11	1Y to 4Y	Data Outputs
7	GND	Ground (0V)
14	V _{CC}	Positive Supply Voltage

Table 3: Truth Table

A	G	Y
X	L	Z
L	H	L
H	H	H

X : Don't Care
Z : High Impedance

Table 4: Absolute Maximum Ratings

Symbol	Parameter	Value	Unit
V _{CC}	Supply Voltage	-0.5 to +7.0	V
V _I	DC Input Voltage	-0.5 to +7.0	V
V _O	DC Output Voltage	-0.5 to V _{CC} + 0.5	V
I _{IK}	DC Input Diode Current	- 20	mA
I _{OK}	DC Output Diode Current	± 20	mA
I _O	DC Output Current	± 25	mA
I _{CC} or I _{GND}	DC V _{CC} or Ground Current	± 50	mA
T _{stg}	Storage Temperature	-65 to +150	°C
T _L	Lead Temperature (10 sec)	300	°C

Absolute Maximum Ratings are those values beyond which damage to the device may occur. Functional operation under these conditions is not implied

Table 5: Recommended Operating Conditions

Symbol	Parameter	Value	Unit
V _{CC}	Supply Voltage	2 to 5.5	V
V _I	Input Voltage	0 to 5.5	V
V _O	Output Voltage	0 to V _{CC}	V
T _{op}	Operating Temperature	-55 to 125	°C
dt/dv	Input Rise and Fall Time (note 1) (V _{CC} = 3.3 ± 0.3V) (V _{CC} = 5.0 ± 0.5V)	0 to 100 0 to 20	ns/V

1) V_{IN} from 30% to 70% of V_{CC}

Table 6: DC Specifications

Symbol	Parameter	Test Condition		Value						Unit	
		V _{CC} (V)		T _A = 25°C			-40 to 85°C		-55 to 125°C		
				Min.	Typ.	Max.	Min.	Max.	Min.		Max.
V _{IH}	High Level Input Voltage	2.0		1.5			1.5		1.5		V
		3.0 to 5.5		0.7V _{CC}			0.7V _{CC}		0.7V _{CC}		
V _{IL}	Low Level Input Voltage	2.0				0.5		0.5		0.5	V
		3.0 to 5.5				0.3V _{CC}		0.3V _{CC}		0.3V _{CC}	
V _{OH}	High Level Output Voltage	2.0	I _O =-50 μA	1.9	2.0		1.9		1.9		V
		3.0	I _O =-50 μA	2.9	3.0		2.9		2.9		
		4.5	I _O =-50 μA	4.4	4.5		4.4		4.4		
		3.0	I _O =-4 mA	2.58			2.48		2.4		
		4.5	I _O =-8 mA	3.94			3.8		3.7		
V _{OL}	Low Level Output Voltage	2.0	I _O =50 μA		0.0	0.1		0.1		0.1	V
		3.0	I _O =50 μA		0.0	0.1		0.1		0.1	
		4.5	I _O =50 μA		0.0	0.1		0.1		0.1	
		3.0	I _O =4 mA			0.36		0.44		0.55	
		4.5	I _O =8 mA			0.36		0.44		0.55	
I _{OZ}	High Impedance Output Leakage Current	5.5	V _I = V _{IH} or V _{IL} V _O = V _{CC} or GND			±0.25		± 2.5		± 2.5	μA
I _I	Input Leakage Current	0 to 5.5	V _I = 5.5V or GND			± 0.1		± 1		± 1	μA
I _{CC}	Quiescent Supply Current	5.5	V _I = V _{CC} or GND			4		40		40	μA

Table 7: AC Electrical Characteristics (Input t_r = t_f = 3ns)

Symbol	Parameter	Test Condition		Value						Unit		
		V _{CC} (V)	C _L (pF)		T _A = 25°C			-40 to 85°C			-55 to 125°C	
					Min.	Typ.	Max.	Min.	Max.		Min.	Max.
t _{PLH} t _{PHL}	Propagation Delay Time	3.3 ^(*)	15			5.6	8.0	1.0	9.5	1.0	9.5	ns
		3.3 ^(*)	50			8.1	11.5	1.0	13.0	1.0	13.0	
		5.0 ^(**)	15			3.8	5.5	1.0	6.5	1.0	6.5	
		5.0 ^(**)	50			5.3	7.5	1.0	8.5	1.0	8.5	
t _{PZL} t _{PHZ}	Output Disable Time	3.3 ^(*)	15	R _L = 1 KΩ		5.4	8.0	1.0	9.5	1.0	9.5	ns
		3.3 ^(*)	50	R _L = 1 KΩ		7.9	11.5	1.0	13.0	1.0	13.0	
		5.0 ^(**)	15	R _L = 1 KΩ		3.6	5.1	1.0	6.0	1.0	6.0	
		5.0 ^(**)	50	R _L = 1 KΩ		5.1	7.1	1.0	8.0	1.0	8.0	
t _{PZL} t _{PZH}	Output Enable Time	3.3 ^(*)	50	R _L = 1 KΩ		9.5	13.2	1.0	15.0	1.0	15.0	ns
		5.0 ^(**)	50	R _L = 1 KΩ		6.1	8.8	1.0	10.0	1.0	10.0	

(*) Voltage range is 3.3V ± 0.3V

(**) Voltage range is 5.0V ± 0.5V

Table 8: Capacitive Characteristics

Symbol	Parameter	Test Condition		Value						Unit	
				T _A = 25°C			-40 to 85°C		-55 to 125°C		
				Min.	Typ.	Max.	Min.	Max.	Min.		Max.
C _{IN}	Input Capacitance		6	10		10		10	pF		
C _{OUT}	Output Capacitance		8						pF		
C _{PD}	Power Dissipation Capacitance (note 1)		17						pF		

1) C_{PD} is defined as the value of the IC's internal equivalent capacitance which is calculated from the operating current consumption without load. (Refer to Test Circuit). Average operating current can be obtained by the following equation. $I_{CC(opr)} = C_{PD} \times V_{CC} \times f_{IN} + I_{CC}/4$ (per circuit)

Table 9: Dynamic Switching Characteristics

Symbol	Parameter	Test Condition		Value						Unit		
				V _{CC} (V)	T _A = 25°C			-40 to 85°C			-55 to 125°C	
					Min.	Typ.	Max.	Min.	Max.		Min.	Max.
V _{OLP}	Dynamic Low Voltage Quiet Output (note 1, 2)	5.0	C _L = 50 pF		0.3	0.8					V	
V _{OLV}				-0.8	-0.3							
V _{IHD}	Dynamic High Voltage Input (note 1, 3)	5.0		3.5						V		
V _{ILD}	Dynamic Low Voltage Input (note 1, 3)	5.0				1.5					V	

1) Worst case package.

2) Max number of outputs defined as (n). Data inputs are driven 0V to 5.0V, (n-1) outputs switching and one output at GND.

3) Max number of data inputs (n) switching. (n-1) switching 0V to 5.0V. Inputs under test switching: 5.0V to threshold (V_{ILD}), 0V to threshold (V_{IHD}), f=1MHz.

Figure 3: Test Circuit

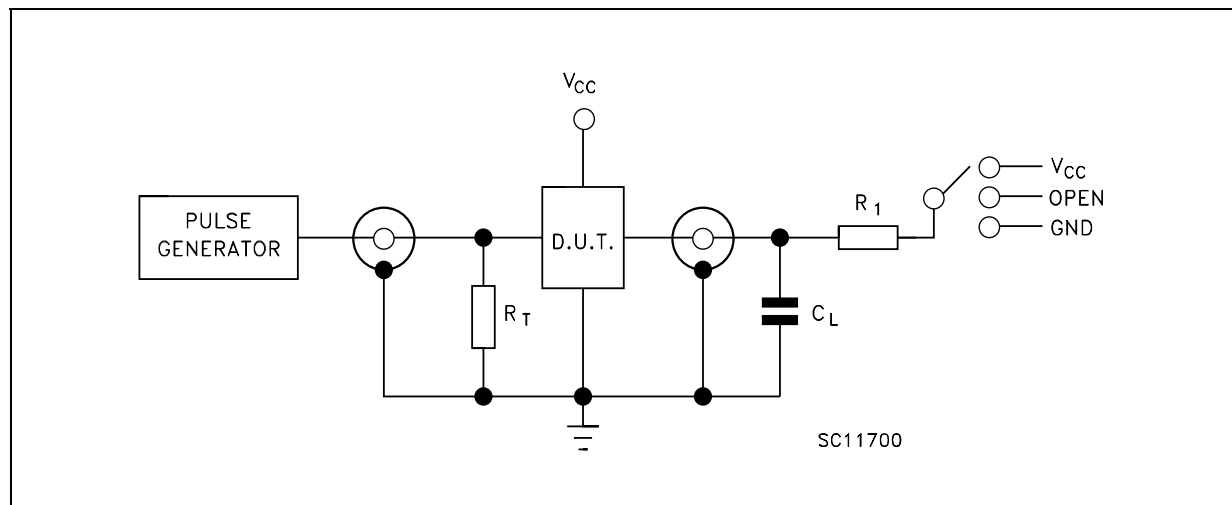

TEST	SWITCH
t_{PLH} , t_{PHL}	Open
t_{PZL} , t_{PLZ}	V_{CC}
t_{PZH} , t_{PHZ}	GND

$C_L = 15/50\text{pF}$ or equivalent (includes jig and probe capacitance)

$R_L = R_1 = 1\text{K}\Omega$ or equivalent

$R_T = Z_{OUT}$ of pulse generator (typically 50Ω)

Figure 4: Waveform - Propagation Delays ($f=1\text{MHz}$; 50% duty cycle)

Figure 5: Waveform - Output Enable And Disable Time ($f=1\text{MHz}$; 50% duty cycle)

SO-14 MECHANICAL DATA

DIM.	mm.			inch		
	MIN.	TYP.	MAX.	MIN.	TYP.	MAX.
A	1.35		1.75	0.053		0.069
A1	0.1		0.25	0.004		0.010
A2	1.10		1.65	0.043		0.065
B	0.33		0.51	0.013		0.020
C	0.19		0.25	0.007		0.010
D	8.55		8.75	0.337		0.344
E	3.8		4.0	0.150		0.157
e		1.27			0.050	
H	5.8		6.2	0.228		0.244
h	0.25		0.50	0.010		0.020
L	0.4		1.27	0.016		0.050
k	0°		8°	0°		8°
ddd			0.100			0.004

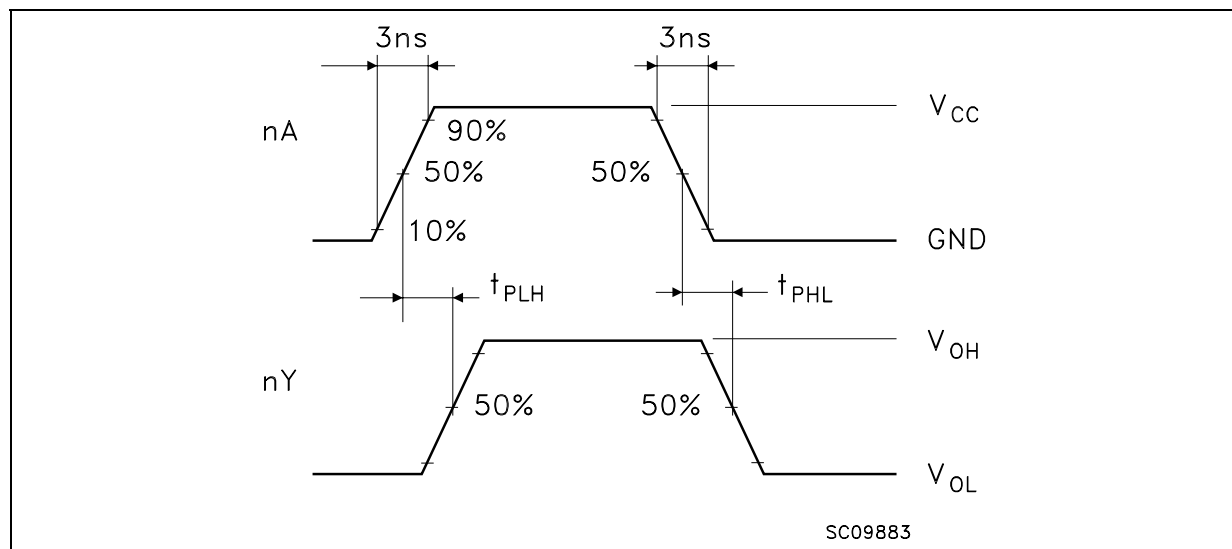
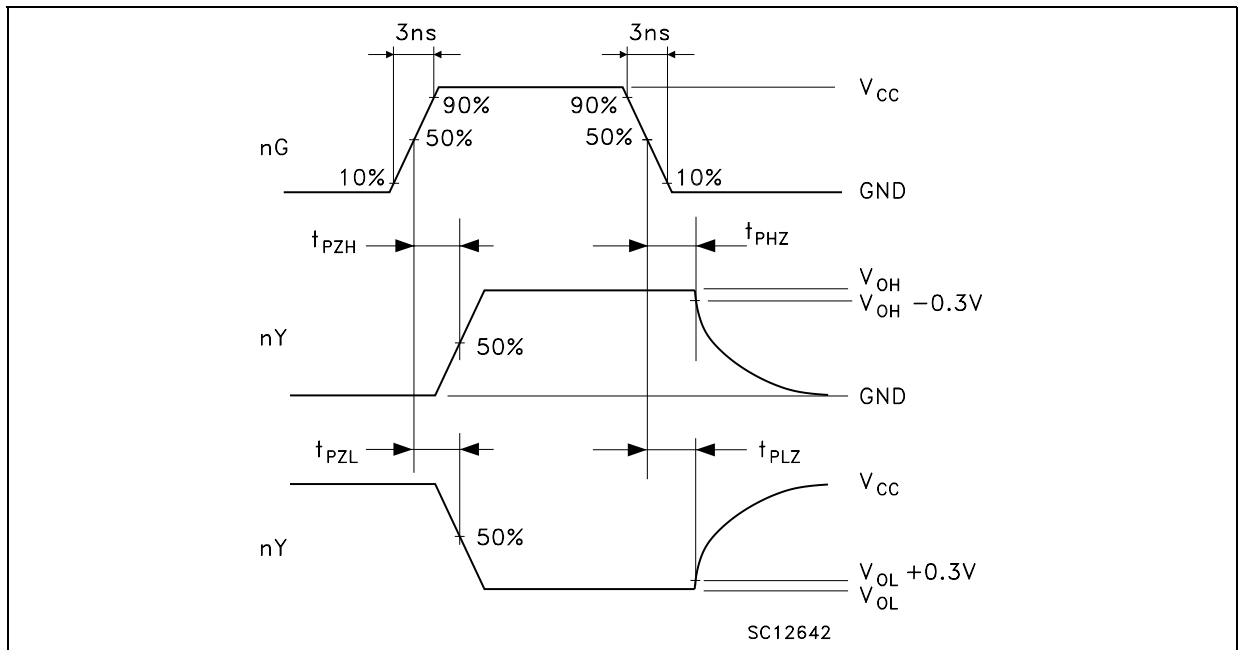
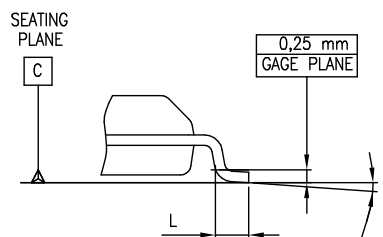
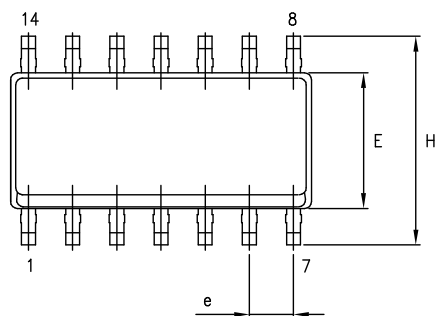
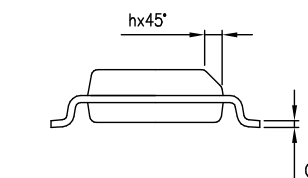
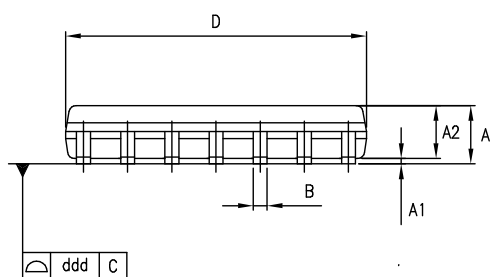

0016019D

TSSOP14 MECHANICAL DATA

DIM.	mm.			inch		
	MIN.	TYP	MAX.	MIN.	TYP.	MAX.
A			1.2			0.047
A1	0.05		0.15	0.002	0.004	0.006
A2	0.8	1	1.05	0.031	0.039	0.041
b	0.19		0.30	0.007		0.012
c	0.09		0.20	0.004		0.0089
D	4.9	5	5.1	0.193	0.197	0.201
E	6.2	6.4	6.6	0.244	0.252	0.260
E1	4.3	4.4	4.48	0.169	0.173	0.176
e		0.65 BSC			0.0256 BSC	
K	0°		8°	0°		8°
L	0.45	0.60	0.75	0.018	0.024	0.030

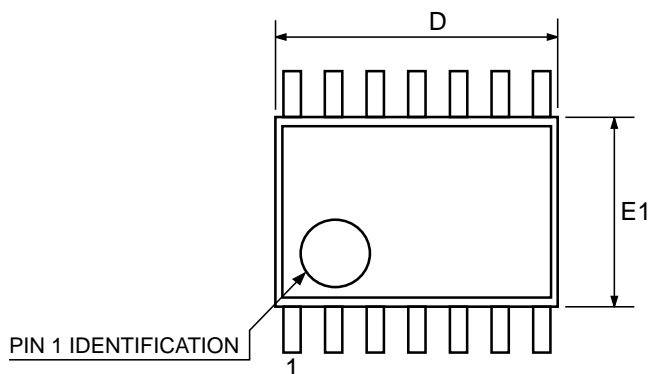
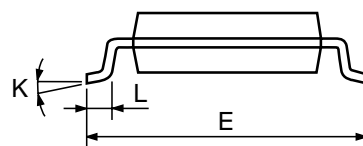
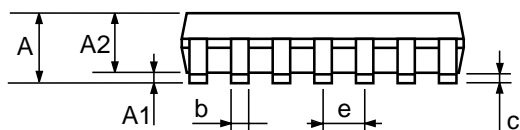

0080337D

Tape & Reel SO-14 MECHANICAL DATA

DIM.	mm.			inch		
	MIN.	TYP	MAX.	MIN.	TYP.	MAX.
A			330			12.992
C	12.8		13.2	0.504		0.519
D	20.2			0.795		
N	60			2.362		
T			22.4			0.882
Ao	6.4		6.6	0.252		0.260
Bo	9		9.2	0.354		0.362
Ko	2.1		2.3	0.082		0.090
Po	3.9		4.1	0.153		0.161
P	7.9		8.1	0.311		0.319

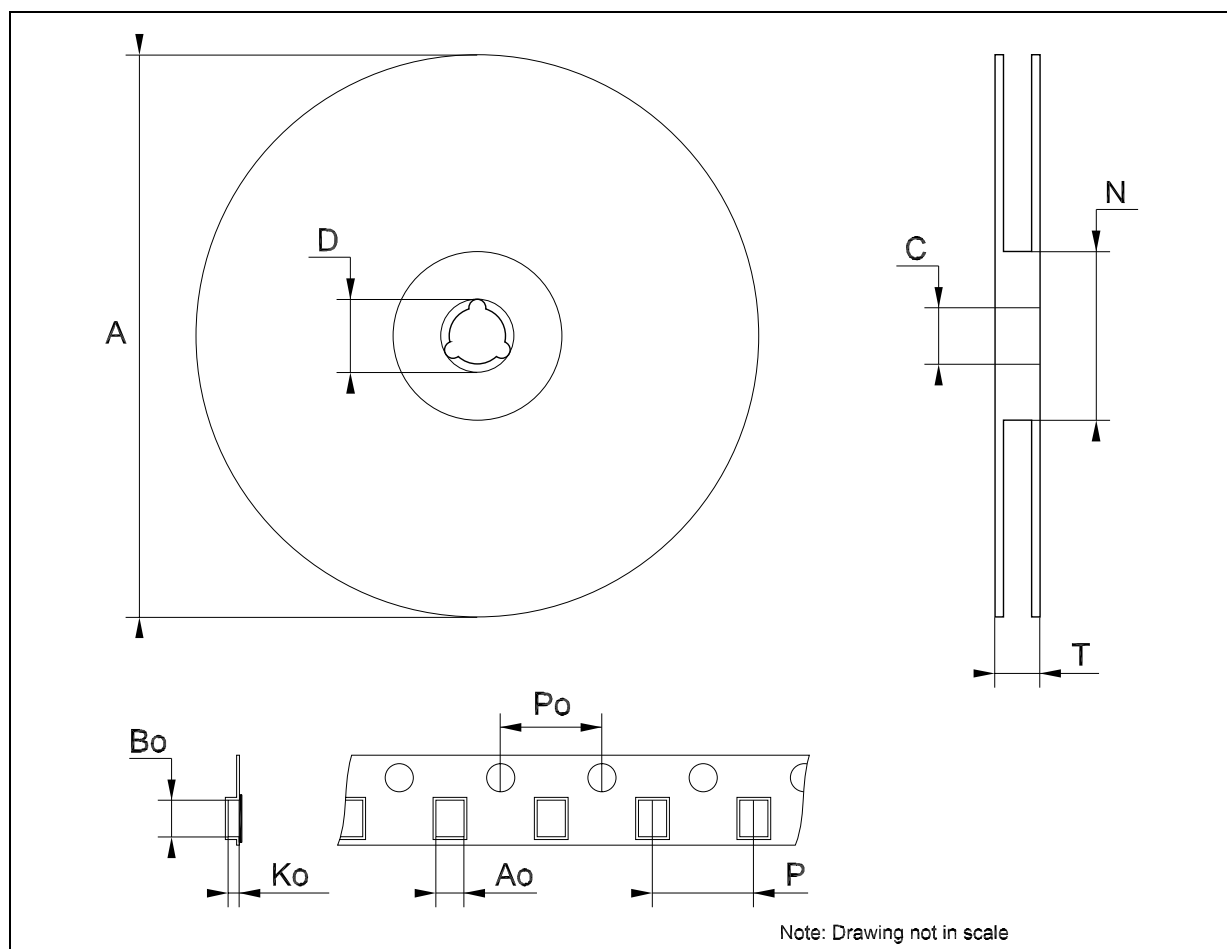

Tape & Reel TSSOP14 MECHANICAL DATA

DIM.	mm.			inch		
	MIN.	TYP	MAX.	MIN.	TYP.	MAX.
A			330			12.992
C	12.8		13.2	0.504		0.519
D	20.2			0.795		
N	60			2.362		
T			22.4			0.882
Ao	6.7		6.9	0.264		0.272
Bo	5.3		5.5	0.209		0.217
Ko	1.6		1.8	0.063		0.071
Po	3.9		4.1	0.153		0.161
P	7.9		8.1	0.311		0.319

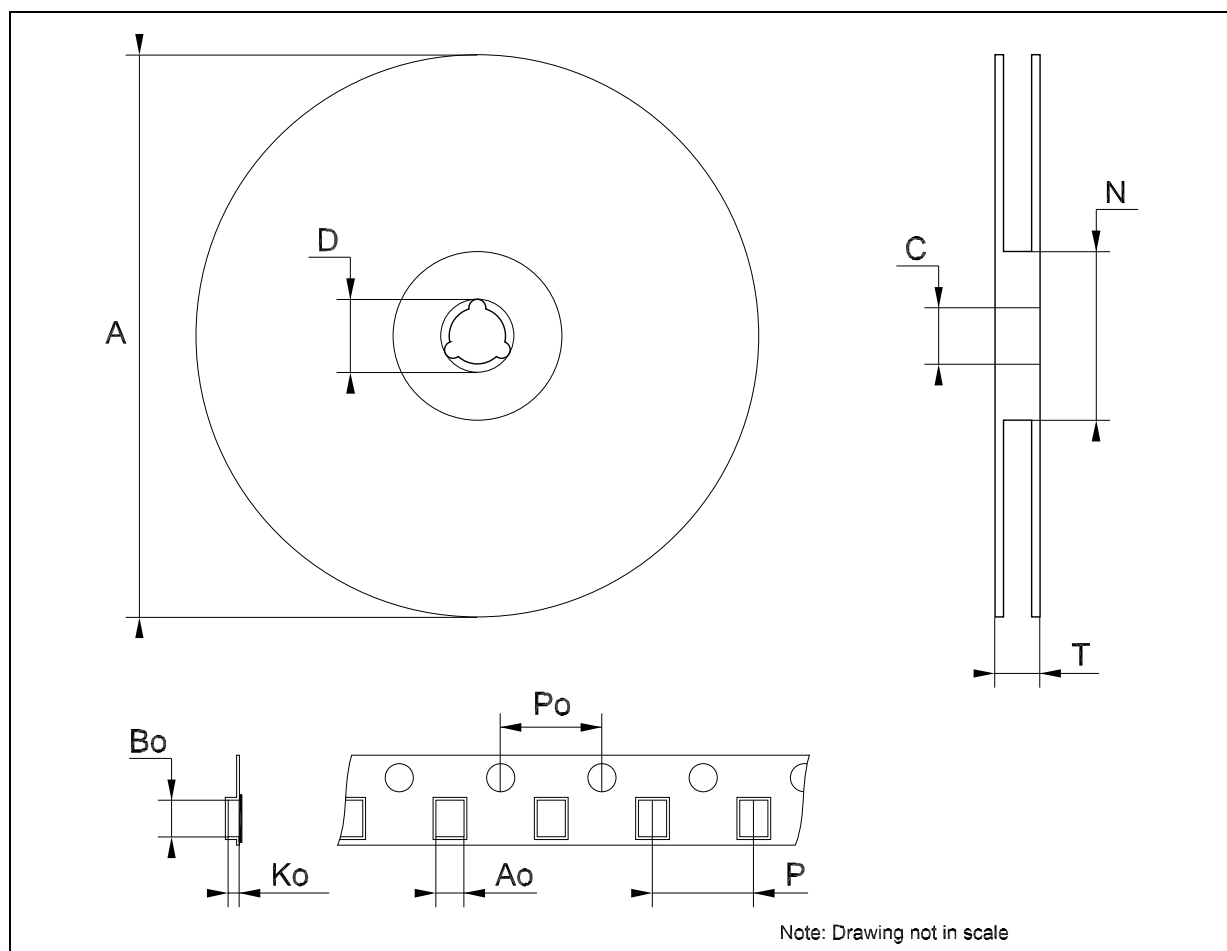

Table 10: Revision History

Date	Revision	Description of Changes
12-Nov-2004	5	Order Codes Revision - pag. 1.

Information furnished is believed to be accurate and reliable. However, STMicroelectronics assumes no responsibility for the consequences of use of such information nor for any infringement of patents or other rights of third parties which may result from its use. No license is granted by implication or otherwise under any patent or patent rights of STMicroelectronics. Specifications mentioned in this publication are subject to change without notice. This publication supersedes and replaces all information previously supplied. STMicroelectronics products are not authorized for use as critical components in life support devices or systems without express written approval of STMicroelectronics.

The ST logo is a registered trademark of STMicroelectronics

All other names are the property of their respective owners

© 2004 STMicroelectronics - All Rights Reserved

STMicroelectronics group of companies

Australia - Belgium - Brazil - Canada - China - Czech Republic - Finland - France - Germany - Hong Kong - India - Israel - Italy - Japan - Malaysia - Malta - Morocco - Singapore - Spain - Sweden - Switzerland - United Kingdom - United States of America

www.st.com



LittleDiode supplies new, hard to find or obsolete electronic components and semiconductors all over the world.

With over two million different components listed you are sure to find the part you need.

Feel free to visit us today at our online store:

LittleDiode.com

Looking forward to providing you with the best possible service.