

BAV70 series

High-speed switching diodes

Rev. 07 — 27 November 2007

Product data sheet

1. Product profile

1.1 General description

High-speed switching diodes, encapsulated in small Surface-Mounted Device (SMD) plastic packages.

Table 1. Product overview

Type number	Package			Package configuration	Configuration
	NXP	JEITA	JEDEC		
BAV70	SOT23	-	TO-236AB	small	dual common cathode
BAV70M	SOT883	SC-101	-	leadless ultra small	dual common cathode
BAV70S	SOT363	SC-88	-	very small	quadruple common cathode/common cathode
BAV70T	SOT416	SC-75	-	ultra small	dual common cathode
BAV70W	SOT323	SC-70	-	very small	dual common cathode

1.2 Features

- High switching speed: $t_{rr} \leq 4$ ns
- Low leakage current
- Small SMD plastic packages
- Low capacitance: $C_d \leq 1.5$ pF
- Reverse voltage: $V_R \leq 100$ V

1.3 Applications

- High-speed switching
- General-purpose switching

1.4 Quick reference data

Table 2. Quick reference data

Symbol	Parameter	Conditions	Min	Typ	Max	Unit
Per diode						
I_R	reverse current	$V_R = 80$ V	-	-	0.5	μ A
V_R	reverse voltage		-	-	100	V
t_{rr}	reverse recovery time		[1]	-	4	ns

[1] When switched from $I_F = 10$ mA to $I_R = 10$ mA; $R_L = 100$ Ω ; measured at $I_R = 1$ mA.

2. Pinning information

Table 3. Pinning

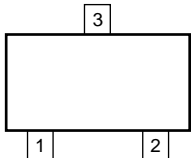
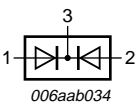
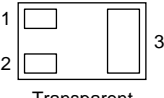
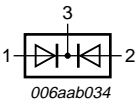
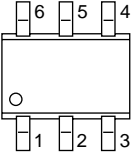
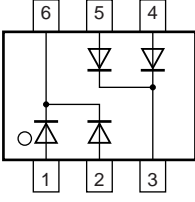
Pin	Description	Simplified outline	Symbol
BAV70; BAV70T; BAV70W			
1	anode (diode 1)	 <p>006aaa144</p>	 <p>006aab034</p>
2	anode (diode 2)		
3	common cathode		
BAV70M			
1	anode (diode 1)	 <p>Transparent top view</p>	 <p>006aab034</p>
2	anode (diode 2)		
3	common cathode		
BAV70S			
1	anode (diode 1)		 <p>006aab104</p>
2	anode (diode 2)		
3	common cathode (diode 3 and diode 4)		
4	anode (diode 3)		
5	anode (diode 4)		
6	common cathode (diode 1 and diode 2)		

3. Ordering information

Table 4. Ordering information

Type number	Package		Version
	Name	Description	
BAV70	-	plastic surface-mounted package; 3 leads	SOT23
BAV70M	SC-101	leadless ultra small plastic package; 3 solder lands; body 1.0 × 0.6 × 0.5 mm	SOT883
BAV70S	SC-88	plastic surface-mounted package; 6 leads	SOT363
BAV70T	SC-75	plastic surface-mounted package; 3 leads	SOT416
BAV70W	SC-70	plastic surface-mounted package; 3 leads	SOT323

4. Marking

Table 5. Marking codes

Type number	Marking code ^[1]
BAV70	A4*
BAV70M	S4
BAV70S	A4*
BAV70T	A4
BAV70W	A4*

- [1] * = -: made in Hong Kong
 * = p: made in Hong Kong
 * = t: made in Malaysia
 * = W: made in China

5. Limiting values

Table 6. Limiting values

In accordance with the Absolute Maximum Rating System (IEC 60134).

Symbol	Parameter	Conditions	Min	Max	Unit
Per diode					
V_{RRM}	repetitive peak reverse voltage		-	100	V
V_R	reverse voltage		-	100	V
I_F	forward current				
	BAV70	$T_{amb} \leq 25\text{ °C}$	-	215	mA
	BAV70M	$T_s = 90\text{ °C}$	-	150	mA
	BAV70S	$T_s = 60\text{ °C}$	-	250	mA
	BAV70T	$T_s = 90\text{ °C}$	-	150	mA
	BAV70W	$T_{amb} \leq 25\text{ °C}$	-	175	mA
I_{FRM}	repetitive peak forward current				
	BAV70		-	450	mA
	BAV70M		-	500	mA
	BAV70S		-	450	mA
	BAV70T		-	500	mA
	BAV70W		-	500	mA
I_{FSM}	non-repetitive peak forward current	square wave			
		$t_p = 1\ \mu\text{s}$	-	4	A
		$t_p = 1\ \text{ms}$	-	1	A
		$t_p = 1\ \text{s}$	-	0.5	A

Table 6. Limiting values ...continued

In accordance with the Absolute Maximum Rating System (IEC 60134).

Symbol	Parameter	Conditions	Min	Max	Unit
P_{tot}	total power dissipation		[2]		
	BAV70	$T_{amb} \leq 25\text{ °C}$	-	250	mW
	BAV70M	$T_{amb} \leq 25\text{ °C}$	[3]	250	mW
	BAV70S	$T_s = 60\text{ °C}$	-	350	mW
	BAV70T	$T_s = 90\text{ °C}$	-	170	mW
	BAV70W	$T_{amb} \leq 25\text{ °C}$	-	200	mW
Per device					
I_F	forward current				
	BAV70	$T_{amb} \leq 25\text{ °C}$	-	125	mA
	BAV70M	$T_s = 90\text{ °C}$	-	75	mA
	BAV70S	$T_s = 60\text{ °C}$	-	100	mA
	BAV70T	$T_s = 90\text{ °C}$	-	75	mA
	BAV70W	$T_{amb} \leq 25\text{ °C}$	-	100	mA
T_j	junction temperature		-	150	°C
T_{amb}	ambient temperature		-65	+150	°C
T_{stg}	storage temperature		-65	+150	°C

[1] $T_j = 25\text{ °C}$ prior to surge.

[2] Device mounted on an FR4 Printed-Circuit Board (PCB), single-sided copper, tin-plated and standard footprint.

[3] Reflow soldering is the only recommended soldering method.

6. Thermal characteristics

Table 7. Thermal characteristics

Symbol	Parameter	Conditions	Min	Typ	Max	Unit
Per diode						
$R_{th(j-a)}$	thermal resistance from junction to ambient	in free air	[1]			
	BAV70		-	-	500	K/W
	BAV70M		[2]	-	500	K/W
	BAV70W		-	-	625	K/W
$R_{th(j-t)}$	thermal resistance from junction to tie-point					
	BAV70		-	-	360	K/W
	BAV70W		-	-	300	K/W
$R_{th(j-sp)}$	thermal resistance from junction to solder point					
	BAV70S		-	-	255	K/W
	BAV70T		-	-	350	K/W

[1] Device mounted on an FR4 PCB, single-sided copper, tin-plated and standard footprint.

[2] Reflow soldering is the only recommended soldering method.

7. Characteristics

Table 8. Characteristics

$T_{amb} = 25\text{ °C}$ unless otherwise specified.

Symbol	Parameter	Conditions	Min	Typ	Max	Unit
Per diode						
V_F	forward voltage		[1]			
		$I_F = 1\text{ mA}$	-	-	715	mV
		$I_F = 10\text{ mA}$	-	-	855	mV
		$I_F = 50\text{ mA}$	-	-	1	V
I_R	reverse current	$V_R = 25\text{ V}$	-	-	30	nA
		$V_R = 80\text{ V}$	-	-	0.5	μA
		$V_R = 25\text{ V}; T_j = 150\text{ °C}$	-	-	30	μA
		$V_R = 80\text{ V}; T_j = 150\text{ °C}$	-	-	100	μA
C_d	diode capacitance	$V_R = 0\text{ V}; f = 1\text{ MHz}$	-	-	1.5	pF
t_{rr}	reverse recovery time		[2]	-	4	ns
V_{FR}	forward recovery voltage		[3]	-	1.75	V

[1] Pulse test: $t_p \leq 300\text{ }\mu\text{s}$; $\delta \leq 0.02$.

[2] When switched from $I_F = 10\text{ mA}$ to $I_R = 10\text{ mA}$; $R_L = 100\text{ }\Omega$; measured at $I_R = 1\text{ mA}$.

[3] When switched from $I_F = 10\text{ mA}$; $t_r = 20\text{ ns}$.

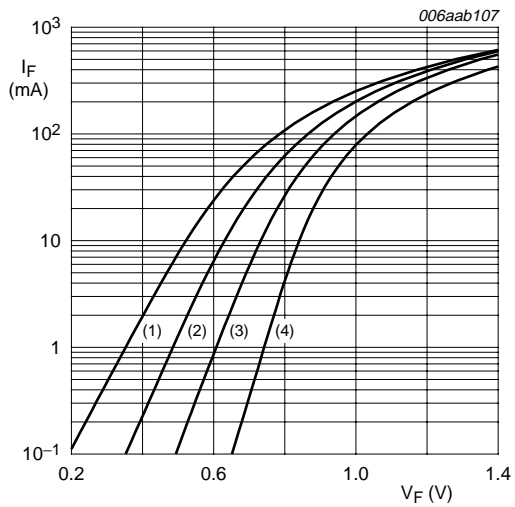

- (1) $T_{amb} = 150\text{ °C}$
- (2) $T_{amb} = 85\text{ °C}$
- (3) $T_{amb} = 25\text{ °C}$
- (4) $T_{amb} = -40\text{ °C}$

Fig 1. Forward current as a function of forward voltage; typical values

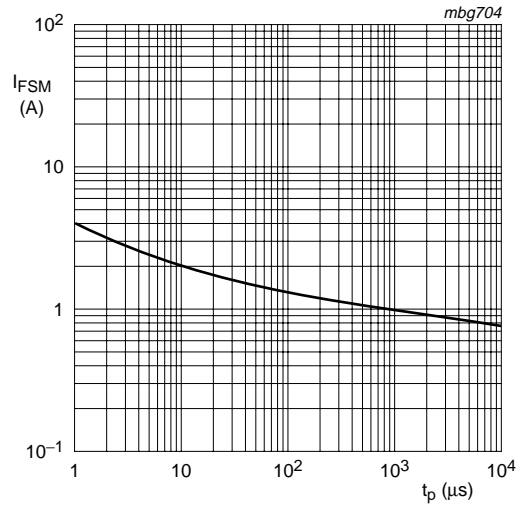

Based on square wave currents.
 $T_j = 25\text{ °C}$; prior to surge

Fig 2. Non-repetitive peak forward current as a function of pulse duration; maximum values

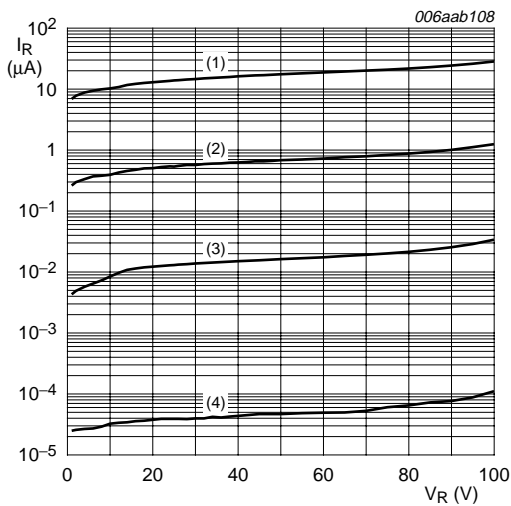

- (1) $T_{amb} = 150\text{ °C}$
- (2) $T_{amb} = 85\text{ °C}$
- (3) $T_{amb} = 25\text{ °C}$
- (4) $T_{amb} = -40\text{ °C}$

Fig 3. Reverse current as a function of reverse voltage; typical values

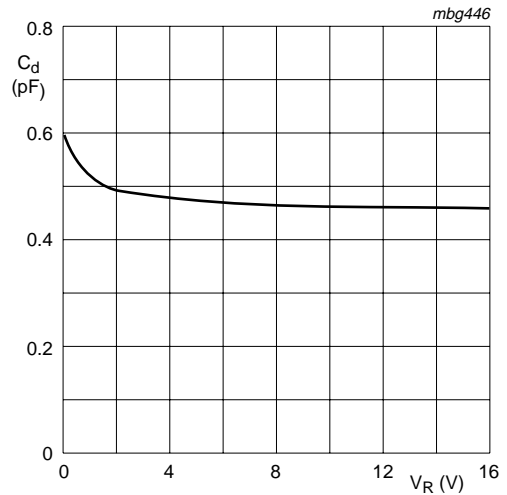

$f = 1\text{ MHz}$; $T_{amb} = 25\text{ °C}$

Fig 4. Diode capacitance as a function of reverse voltage; typical values

8. Test information

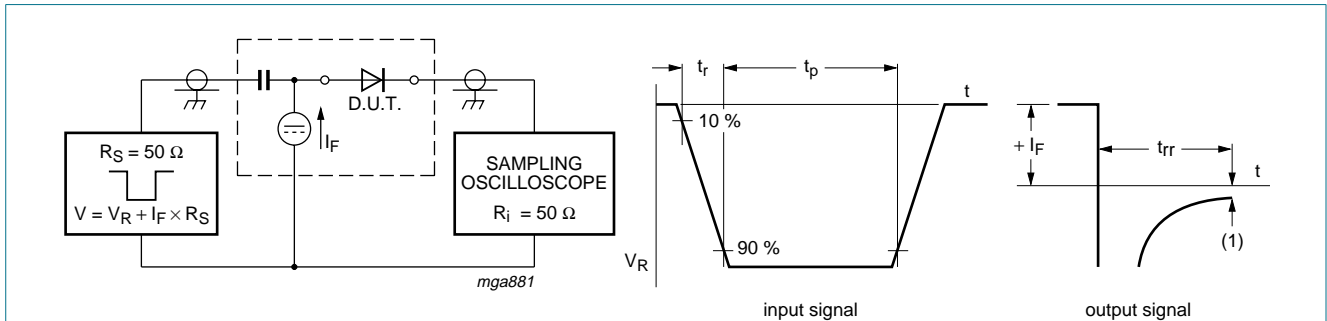

(1) $I_R = 1 \text{ mA}$

Input signal: reverse pulse rise time $t_r = 0.6 \text{ ns}$; reverse voltage pulse duration $t_p = 100 \text{ ns}$; duty cycle $\delta = 0.05$

Oscilloscope: rise time $t_r = 0.35 \text{ ns}$

Fig 5. Reverse recovery time test circuit and waveforms

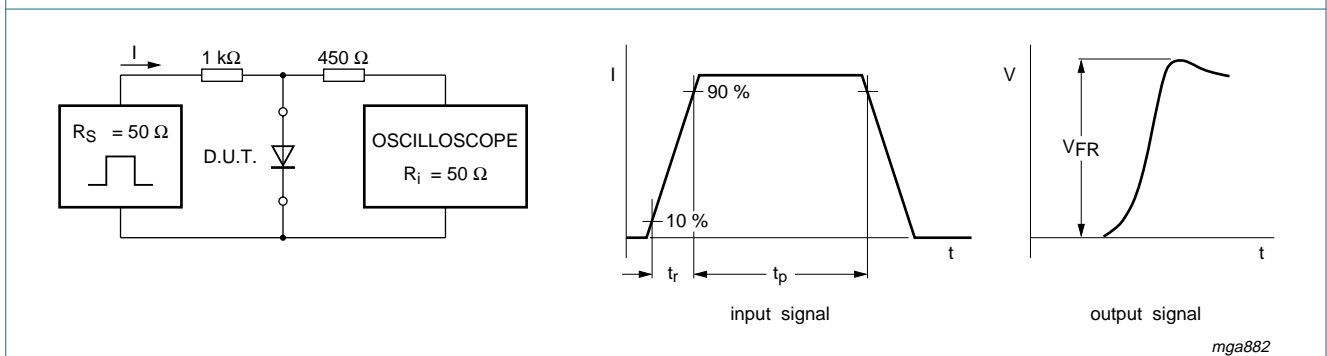

Input signal: forward pulse rise time $t_r = 20 \text{ ns}$; forward current pulse duration $t_p \geq 100 \text{ ns}$; duty cycle $\delta \leq 0.005$

Fig 6. Forward recovery voltage test circuit and waveforms

9. Package outline

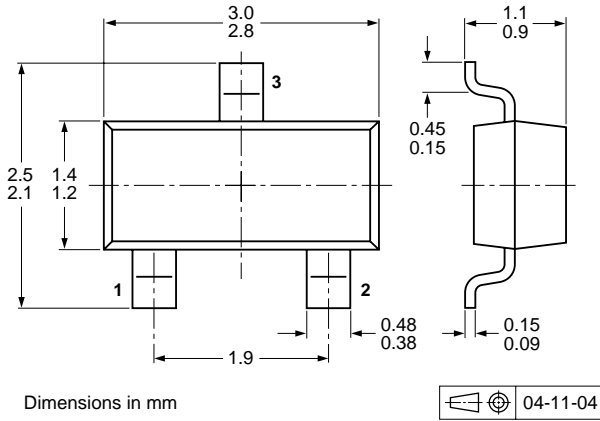

Fig 7. Package outline BAV70 (SOT23/TO-236AB)

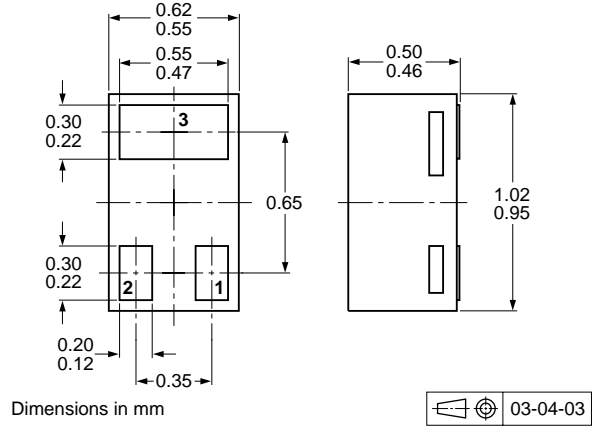

Fig 8. Package outline BAV70M (SOT883/SC-101)

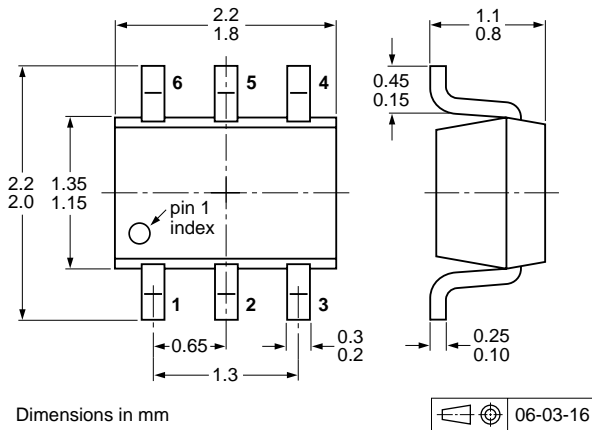

Fig 9. Package outline BAV70S (SOT363/SC-88)

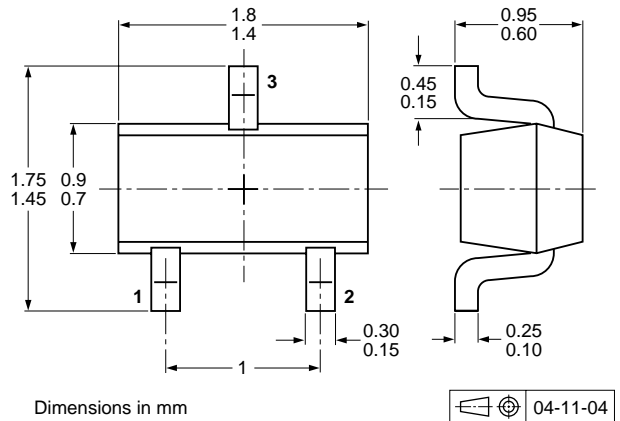

Fig 10. Package outline BAV70T (SOT416/SC-75)

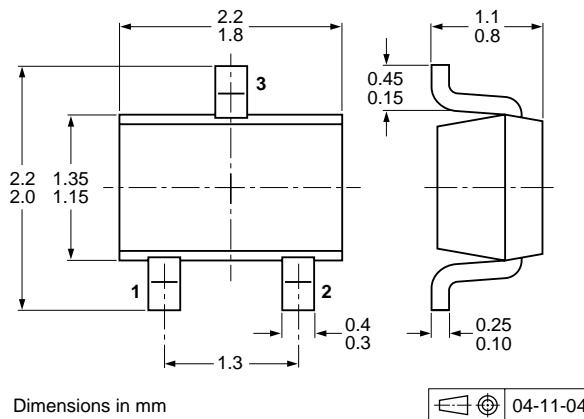

Fig 11. Package outline BAV70W (SOT323/SC-70)

10. Packing information

Table 9. Packing methods

The indicated -xxx are the last three digits of the 12NC ordering code.^[1]

Type number	Package	Description	Packing quantity	
			3000	10000
BAV70	SOT23	4 mm pitch, 8 mm tape and reel	-215	-235
BAV70M	SOT883	2 mm pitch, 8 mm tape and reel	-	-315
BAV70S	SOT363	4 mm pitch, 8 mm tape and reel; T1	^[2] -115	-135
		4 mm pitch, 8 mm tape and reel; T2	^[3] -125	-165
BAV70T	SOT416	4 mm pitch, 8 mm tape and reel	-115	-135
BAV70W	SOT323	4 mm pitch, 8 mm tape and reel	-115	-135

[1] For further information and the availability of packing methods, see [Section 14](#).

[2] T1: normal taping

[3] T2: reverse taping

11. Soldering

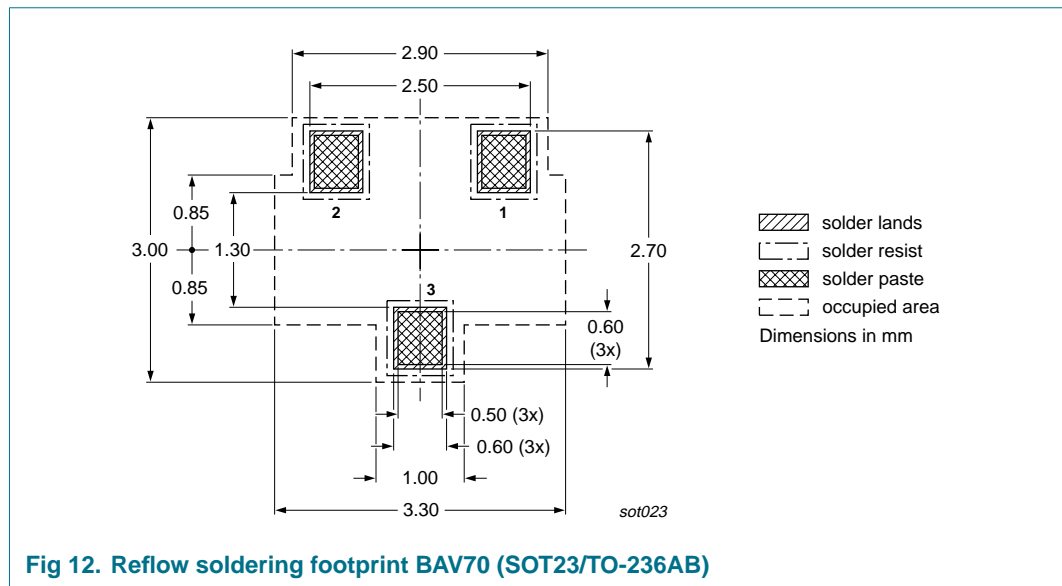

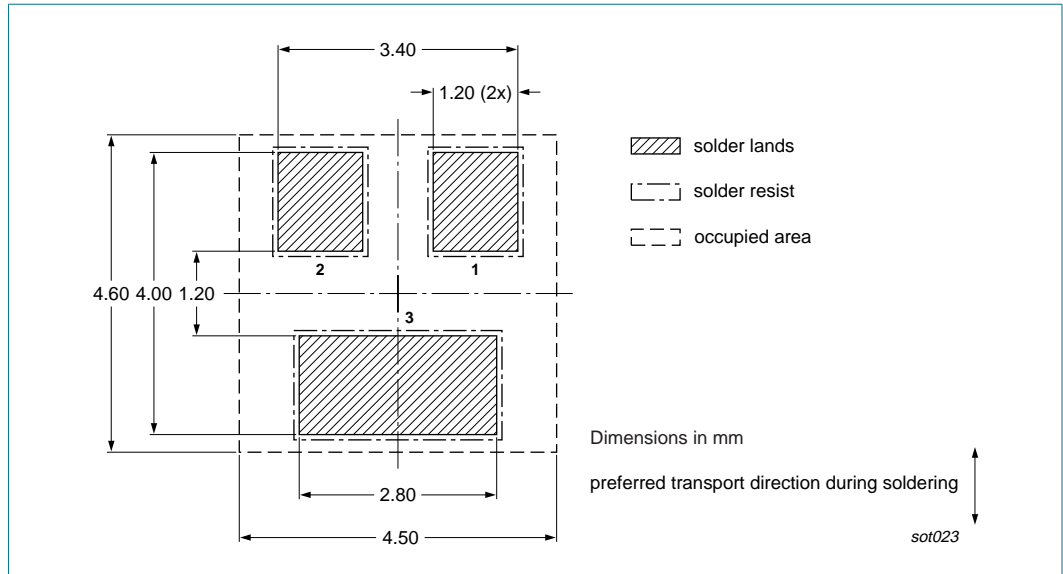

Fig 13. Wave soldering footprint BAV70 (SOT23/TO-236AB)

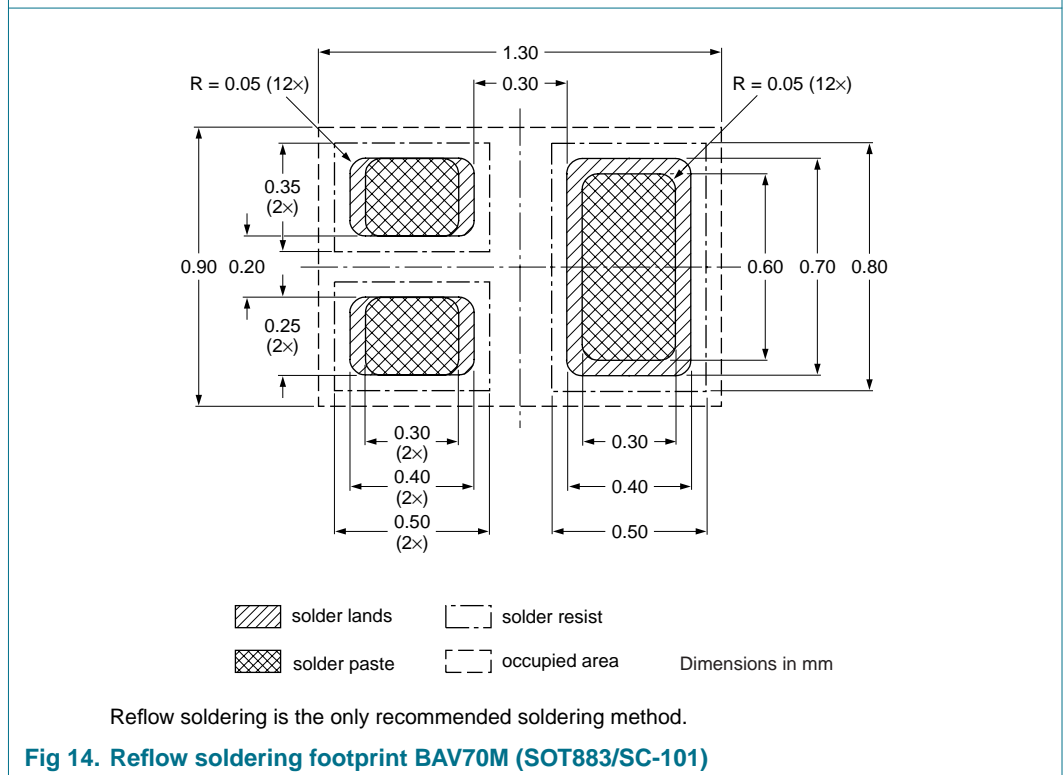

Fig 14. Reflow soldering footprint BAV70M (SOT883/SC-101)

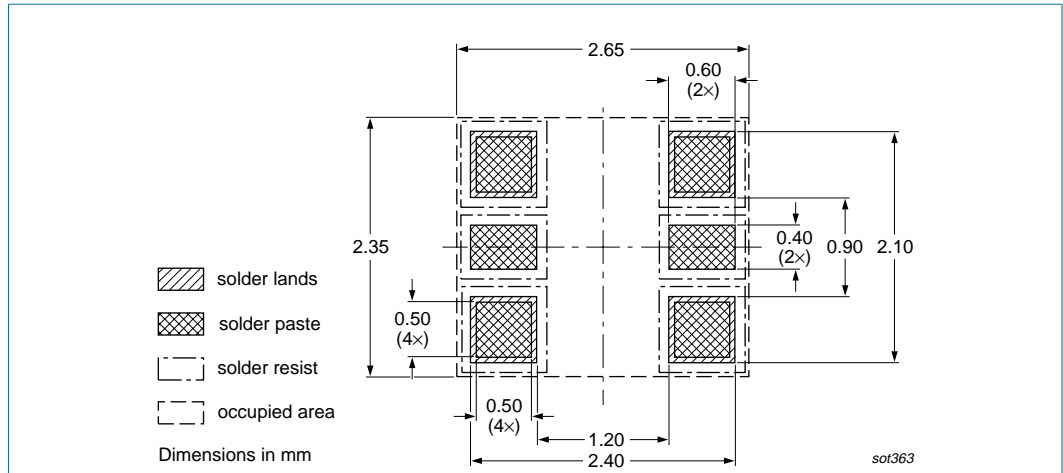

Fig 15. Reflow soldering footprint BAV70S (SOT363/SC-88)

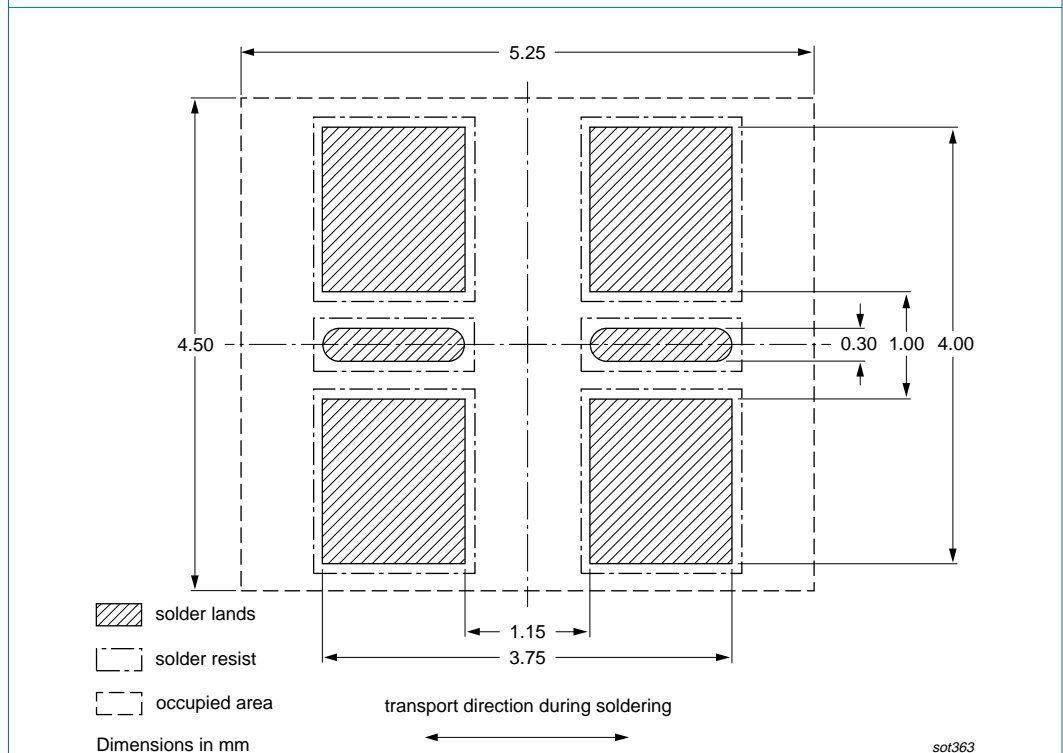

Fig 16. Wave soldering footprint BAV70S (SOT363/SC-88)

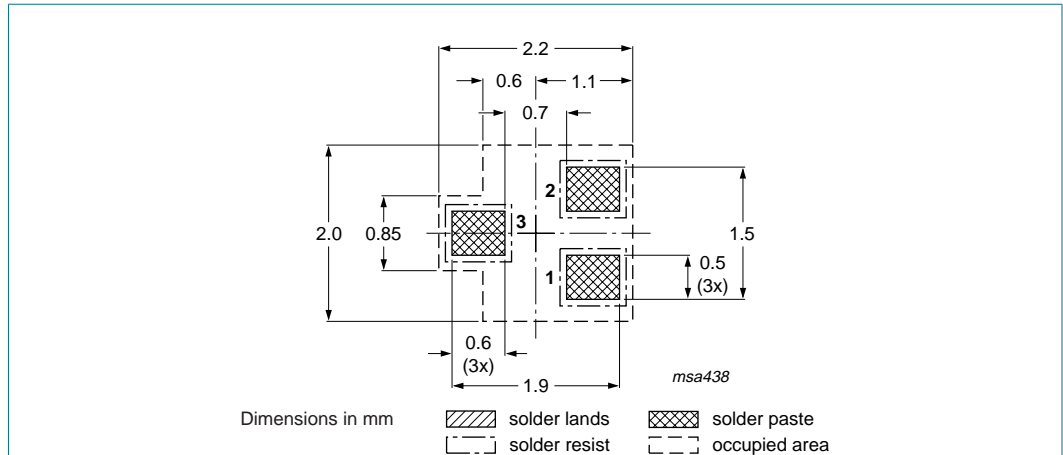

Fig 17. Reflow soldering footprint BAV70T (SOT416/SC-75)

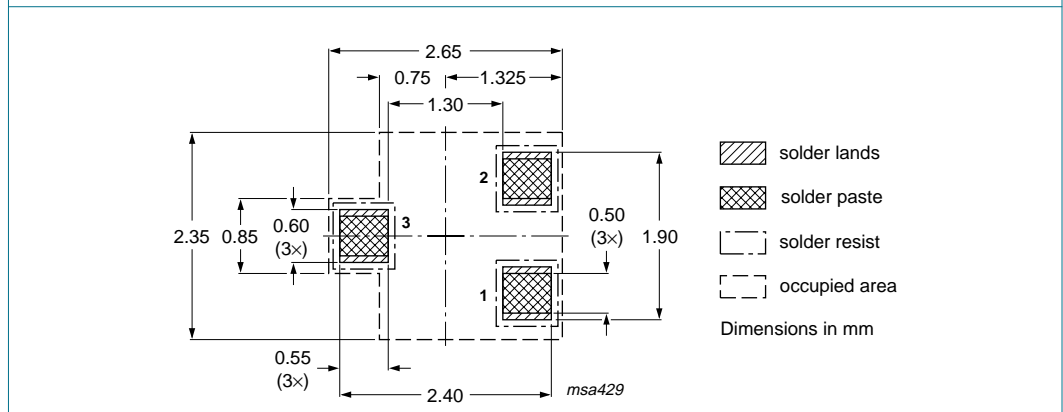

Fig 18. Reflow soldering footprint BAV70W (SOT323/SC-70)

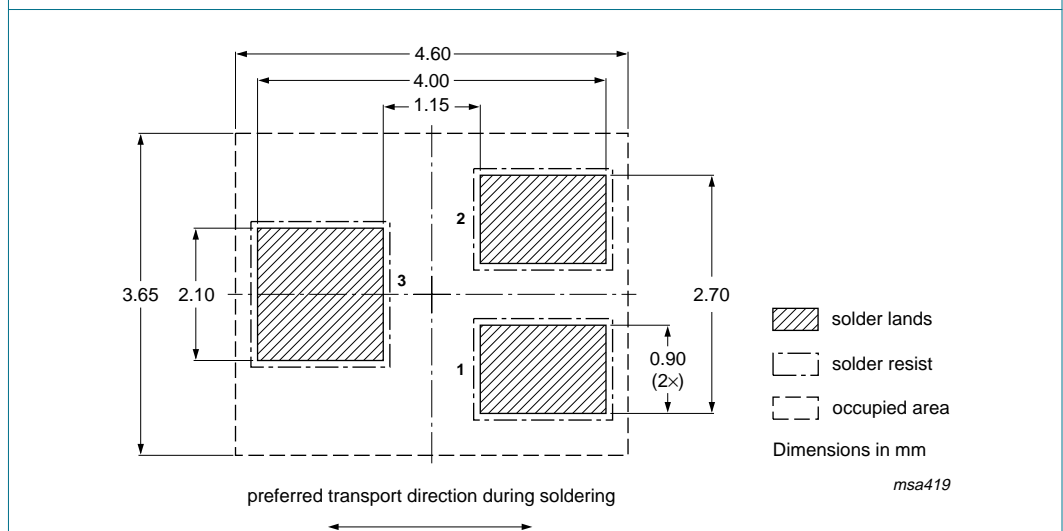

Fig 19. Wave soldering footprint BAV70W (SOT323/SC-70)

12. Revision history

Table 10. Revision history

Document ID	Release date	Data sheet status	Change notice	Supersedes
BAV70_SER_7	20071127	Product data sheet	-	BAV70_6 BAV70S_2 BAV70T_3 BAV70W_6
Modifications:	<ul style="list-style-type: none"> • The format of this data sheet has been redesigned to comply with the new identity guidelines of NXP Semiconductors. • Legal texts have been adapted to the new company name where appropriate. • Type number BAV70M added • Section 1.1 “General description”: amended • Table 1 “Product overview”: added • Table 2 “Quick reference data”: added • Table 6 “Limiting values”: for BAV70, BAV70S and BAV70W change of V_{RRM} maximum value from 85 V to 100 V • Table 6 “Limiting values”: for BAV70, BAV70S and BAV70W change of V_R maximum value from 75 V to 100 V • Table 8 “Characteristics”: for BAV70, BAV70S, BAV70T and BAV70W change of I_R condition V_R from 75 V to 80 V for $T_j = 25\text{ °C}$ • Table 8 “Characteristics”: for BAV70, BAV70S and BAV70W change of I_R maximum value from 2.5 μA to 0.5 μA for $T_j = 25\text{ °C}$ • Table 8 “Characteristics”: for BAV70T change of I_R maximum value from 2.0 μA to 0.5 μA for $T_j = 25\text{ °C}$ • Table 8 “Characteristics”: for BAV70, BAV70S, BAV70T and BAV70W change of I_R maximum value from 60 μA to 30 μA for I_R condition $V_R = 25\text{ V}$; $T_j = 150\text{ °C}$ • Table 8 “Characteristics”: for BAV70, BAV70S, BAV70T and BAV70W change of I_R condition V_R from 75 V to 80 V for $T_j = 150\text{ °C}$ • Section 8 “Test information”: added • Section 10 “Packing information”: added • Section 11 “Soldering”: added • Section 13 “Legal information”: updated 			
BAV70_6	20020403	Product specification	-	BAV70_5
BAV70S_2	19971021	Product specification	-	BAV70S_1
BAV70T_3	20040204	Product specification	-	BAV70T_2
BAV70W_6	20020405	Product specification	-	BAV70W_5

13. Legal information

13.1 Data sheet status

Document status ^{[1][2]}	Product status ^[3]	Definition
Objective [short] data sheet	Development	This document contains data from the objective specification for product development.
Preliminary [short] data sheet	Qualification	This document contains data from the preliminary specification.
Product [short] data sheet	Production	This document contains the product specification.

[1] Please consult the most recently issued document before initiating or completing a design.

[2] The term 'short data sheet' is explained in section "Definitions".

[3] The product status of device(s) described in this document may have changed since this document was published and may differ in case of multiple devices. The latest product status information is available on the Internet at URL <http://www.nxp.com>.

13.2 Definitions

Draft — The document is a draft version only. The content is still under internal review and subject to formal approval, which may result in modifications or additions. NXP Semiconductors does not give any representations or warranties as to the accuracy or completeness of information included herein and shall have no liability for the consequences of use of such information.

Short data sheet — A short data sheet is an extract from a full data sheet with the same product type number(s) and title. A short data sheet is intended for quick reference only and should not be relied upon to contain detailed and full information. For detailed and full information see the relevant full data sheet, which is available on request via the local NXP Semiconductors sales office. In case of any inconsistency or conflict with the short data sheet, the full data sheet shall prevail.

13.3 Disclaimers

General — Information in this document is believed to be accurate and reliable. However, NXP Semiconductors does not give any representations or warranties, expressed or implied, as to the accuracy or completeness of such information and shall have no liability for the consequences of use of such information.

Right to make changes — NXP Semiconductors reserves the right to make changes to information published in this document, including without limitation specifications and product descriptions, at any time and without notice. This document supersedes and replaces all information supplied prior to the publication hereof.

Suitability for use — NXP Semiconductors products are not designed, authorized or warranted to be suitable for use in medical, military, aircraft, space or life support equipment, nor in applications where failure or

malfunction of an NXP Semiconductors product can reasonably be expected to result in personal injury, death or severe property or environmental damage. NXP Semiconductors accepts no liability for inclusion and/or use of NXP Semiconductors products in such equipment or applications and therefore such inclusion and/or use is at the customer's own risk.

Applications — Applications that are described herein for any of these products are for illustrative purposes only. NXP Semiconductors makes no representation or warranty that such applications will be suitable for the specified use without further testing or modification.

Limiting values — Stress above one or more limiting values (as defined in the Absolute Maximum Ratings System of IEC 60134) may cause permanent damage to the device. Limiting values are stress ratings only and operation of the device at these or any other conditions above those given in the Characteristics sections of this document is not implied. Exposure to limiting values for extended periods may affect device reliability.

Terms and conditions of sale — NXP Semiconductors products are sold subject to the general terms and conditions of commercial sale, as published at <http://www.nxp.com/profile/terms>, including those pertaining to warranty, intellectual property rights infringement and limitation of liability, unless explicitly otherwise agreed to in writing by NXP Semiconductors. In case of any inconsistency or conflict between information in this document and such terms and conditions, the latter will prevail.

No offer to sell or license — Nothing in this document may be interpreted or construed as an offer to sell products that is open for acceptance or the grant, conveyance or implication of any license under any copyrights, patents or other industrial or intellectual property rights.

13.4 Trademarks

Notice: All referenced brands, product names, service names and trademarks are the property of their respective owners.

14. Contact information

For additional information, please visit: <http://www.nxp.com>

For sales office addresses, send an email to: salesaddresses@nxp.com

15. Contents

1 Product profile 1

1.1 General description 1

1.2 Features 1

1.3 Applications 1

1.4 Quick reference data 1

2 Pinning information 2

3 Ordering information 2

4 Marking 3

5 Limiting values 3

6 Thermal characteristics 4

7 Characteristics 5

8 Test information 7

9 Package outline 8

10 Packing information 9

11 Soldering 9

12 Revision history 13

13 Legal information 14

13.1 Data sheet status 14

13.2 Definitions 14

13.3 Disclaimers 14

13.4 Trademarks 14

14 Contact information 14

15 Contents 15

Please be aware that important notices concerning this document and the product(s) described herein, have been included in section 'Legal information'.



© NXP B.V. 2007.

All rights reserved.

For more information, please visit: <http://www.nxp.com>

For sales office addresses, please send an email to: salesaddresses@nxp.com

Date of release: 27 November 2007

Document identifier: BAV70_SER_7



LittleDiode supplies new, hard to find or obsolete electronic components and semiconductors all over the world.

With over two million different components listed you are sure to find the part you need.

Feel free to visit us today at our online store:

LittleDiode.com

Looking forward to providing you with the best possible service.