

BC856ALT1 Series

Preferred Devices

General Purpose Transistors

PNP Silicon

Features

- Pb-Free Packages are Available

MAXIMUM RATINGS ($T_A = 25^\circ\text{C}$ unless otherwise noted)

Rating	Symbol	Value	Unit
Collector-Emitter Voltage BC856 BC857 BC858, BC859	V_{CEO}	-65 -45 -30	V
Collector-Base Voltage BC856 BC857 BC858, BC859	V_{CBO}	-80 -50 -30	V
Emitter-Base Voltage	V_{EBO}	-5.0	V
Collector Current – Continuous	I_C	-100	mAdc

Maximum ratings are those values beyond which device damage can occur. Maximum ratings applied to the device are individual stress limit values (not normal operating conditions) and are not valid simultaneously. If these limits are exceeded, device functional operation is not implied, damage may occur and reliability may be affected.

THERMAL CHARACTERISTICS

Characteristic	Symbol	Max	Unit
Total Device Dissipation FR-5 Board, (Note 1) $T_A = 25^\circ\text{C}$ Derate above 25°C	P_D	225 1.8	mW mW/ $^\circ\text{C}$
Thermal Resistance, Junction-to-Ambient	$R_{\theta JA}$	556	$^\circ\text{C}/\text{W}$
Total Device Dissipation Alumina Substrate, (Note 2) $T_A = 25^\circ\text{C}$ Derate above 25°C	P_D	300 2.4	mW mW/ $^\circ\text{C}$
Thermal Resistance, Junction-to-Ambient	$R_{\theta JA}$	417	$^\circ\text{C}/\text{W}$
Junction and Storage Temperature	T_J, T_{stg}	-55 to +150	$^\circ\text{C}$

- FR-5 = 1.0 x 0.75 x 0.062 in.
- Alumina = 0.4 x 0.3 x 0.024 in 99.5% alumina.



ON Semiconductor®

<http://onsemi.com>

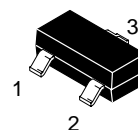
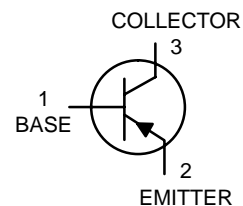

SOT-23
CASE 318
STYLE 6

MARKING DIAGRAM

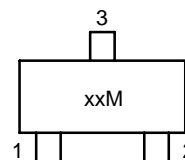

xx = Device Code
M = Date Code

ORDERING INFORMATION

See detailed ordering and shipping information in the package dimensions section on page 6 of this data sheet.

Preferred devices are recommended choices for future use and best overall value.

BC856ALT1 Series

ELECTRICAL CHARACTERISTICS (T_A = 25°C unless otherwise noted)

Characteristic		Symbol	Min	Typ	Max	Unit
OFF CHARACTERISTICS						
Collector–Emitter Breakdown Voltage (I _C = –10 mA)	BC856 Series BC857 Series BC858, BC859 Series	V _{(BR)CEO}	–65 –45 –30	– – –	– – –	V
Collector–Emitter Breakdown Voltage (I _C = –10 μA, V _{EB} = 0)	BC856 Series BC857A, BC857B Only BC858, BC859 Series	V _{(BR)CES}	–80 –50 –30	– – –	– – –	V
Collector–Base Breakdown Voltage (I _C = –10 μA)	BC856 Series BC857 Series BC858, BC859 Series	V _{(BR)CBO}	–80 –50 –30	– – –	– – –	V
Emitter–Base Breakdown Voltage (I _E = –1.0 μA)	BC856 Series BC857 Series BC858, BC859 Series	V _{(BR)EBO}	–5.0 –5.0 –5.0	– – –	– – –	V
Collector Cutoff Current (V _{CB} = –30 V) (V _{CB} = –30 V, T _A = 150°C)		I _{CBO}	– –	– –	–15 –4.0	nA μA
ON CHARACTERISTICS						
DC Current Gain (I _C = –10 μA, V _{CE} = –5.0 V)	BC856A, BC857A, BC858A BC856B, BC857B, BC858B BC857C, BC858C	h _{FE}	– – –	90 150 270	– – –	–
(I _C = –2.0 mA, V _{CE} = –5.0 V)	BC856A, BC857A, BC858A BC856B, BC857B, BC858B, BC859B BC857C, BC858C, BC859C		125 220 420	180 290 520	250 475 800	
Collector–Emitter Saturation Voltage (I _C = –10 mA, I _B = –0.5 mA) (I _C = –100 mA, I _B = –5.0 mA)		V _{CE(sat)}	– –	– –	–0.3 –0.65	V
Base–Emitter Saturation Voltage (I _C = –10 mA, I _B = –0.5 mA) (I _C = –100 mA, I _B = –5.0 mA)		V _{BE(sat)}	– –	–0.7 –0.9	– –	V
Base–Emitter On Voltage (I _C = –2.0 mA, V _{CE} = –5.0 V) (I _C = –10 mA, V _{CE} = –5.0 V)		V _{BE(on)}	–0.6 –	– –	–0.75 –0.82	V
SMALL–SIGNAL CHARACTERISTICS						
Current–Gain – Bandwidth Product (I _C = –10 mA, V _{CE} = –5.0 Vdc, f = 100 MHz)		f _T	100	–	–	MHz
Output Capacitance (V _{CB} = –10 V, f = 1.0 MHz)		C _{ob}	–	–	4.5	pF
Noise Figure (I _C = –0.2 mA, V _{CE} = –5.0 Vdc, R _S = 2.0 kΩ, f = 1.0 kHz, BW = 200 Hz)	BC856, BC857, BC858 Series BC859 Series	NF	– –	– –	10 4.0	dB

BC856ALT1 Series

BC857/BC858/BC859

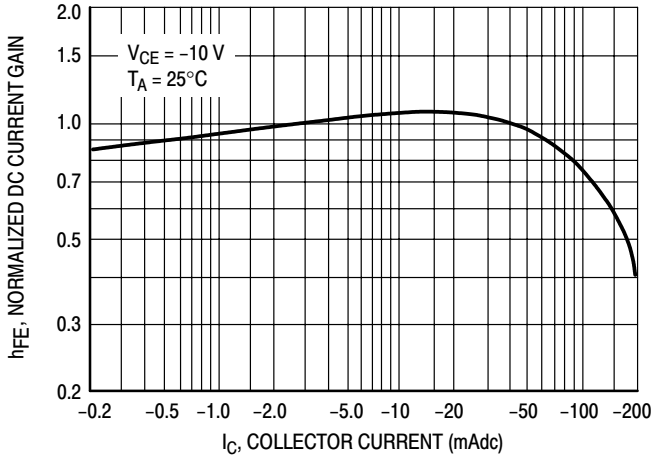

Figure 1. Normalized DC Current Gain

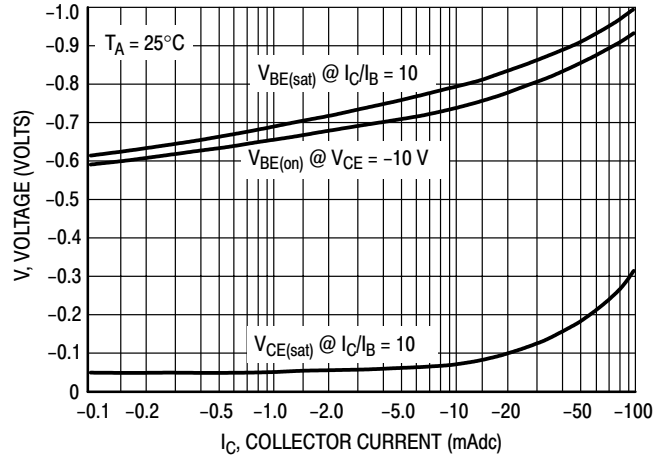

Figure 2. "Saturation" and "On" Voltages

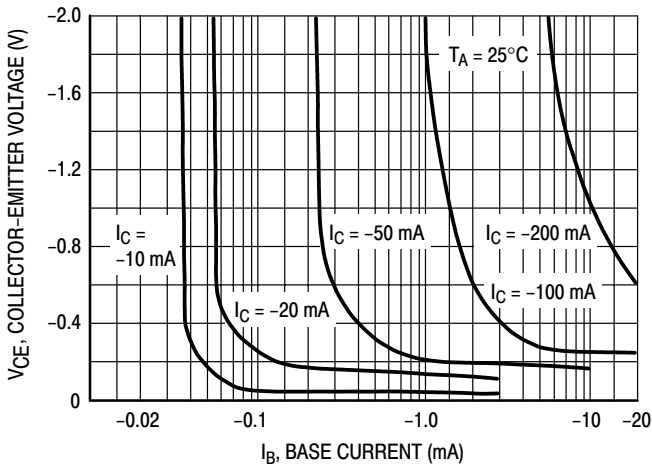

Figure 3. Collector Saturation Region

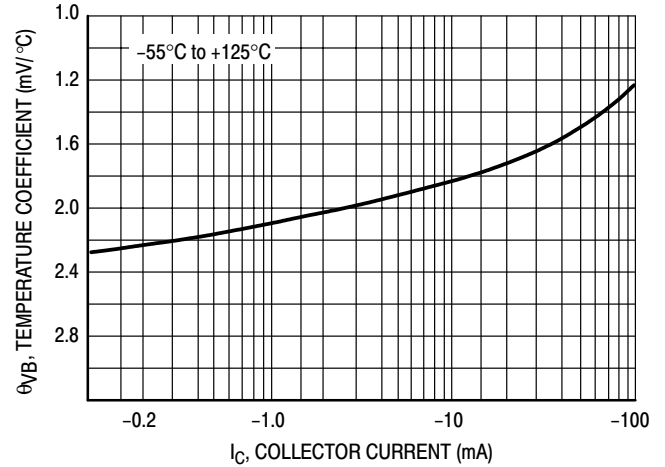

Figure 4. Base-Emitter Temperature Coefficient

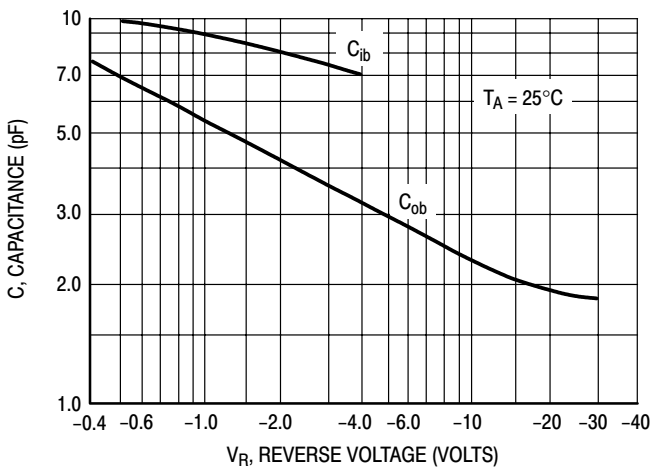

Figure 5. Capacitances

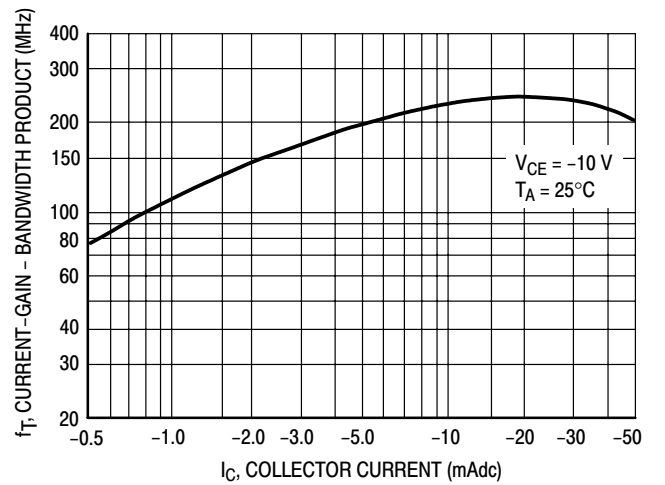

Figure 6. Current-Gain - Bandwidth Product

BC856ALT1 Series

BC856

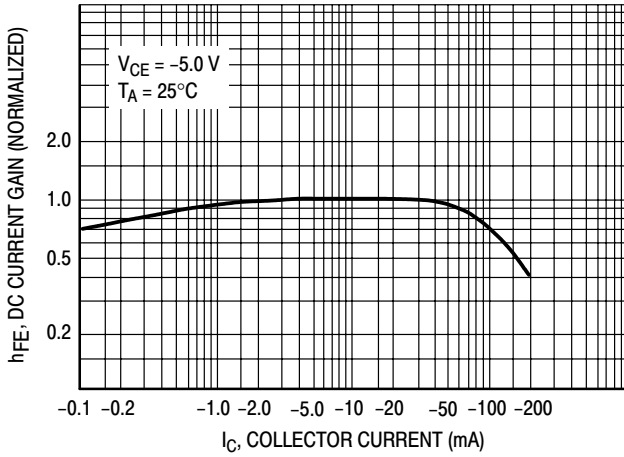

Figure 7. DC Current Gain

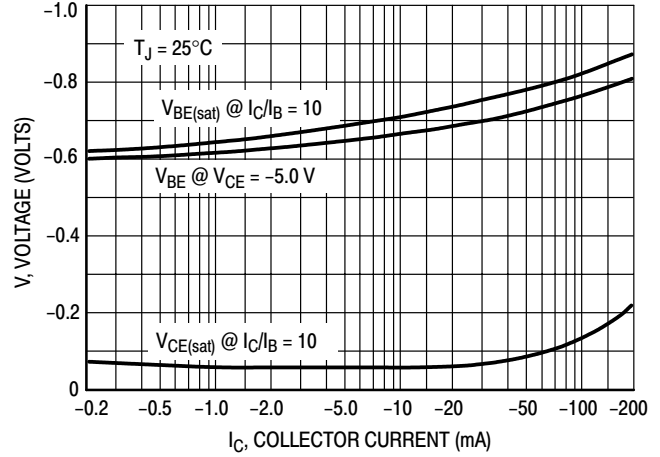

Figure 8. "On" Voltage

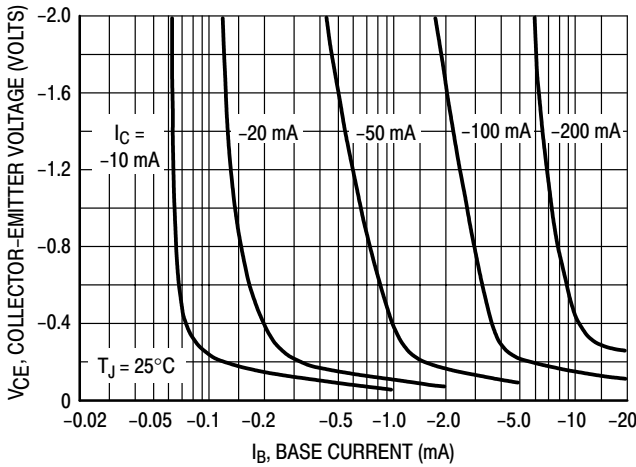

Figure 9. Collector Saturation Region

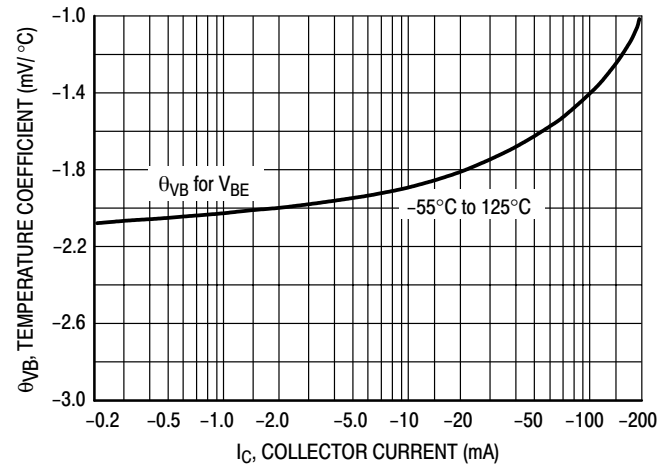

Figure 10. Base-Emitter Temperature Coefficient

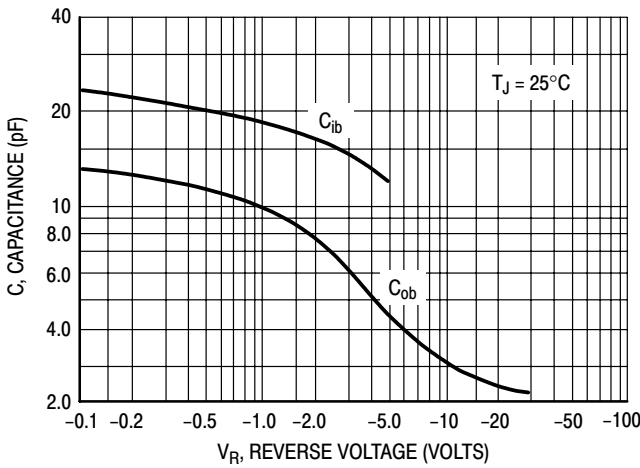

Figure 11. Capacitance

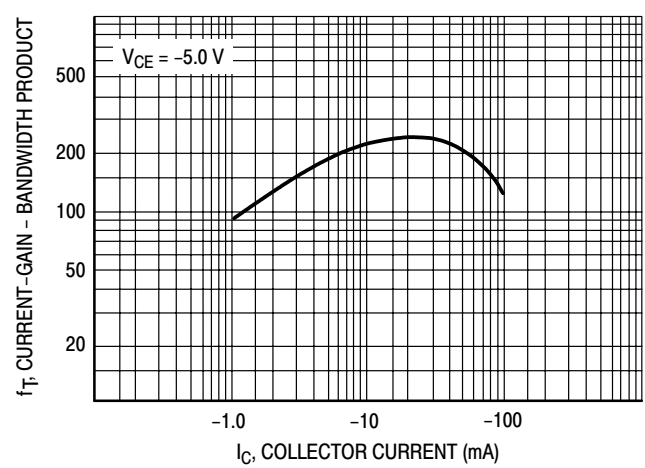

Figure 12. Current-Gain - Bandwidth Product

BC856ALT1 Series

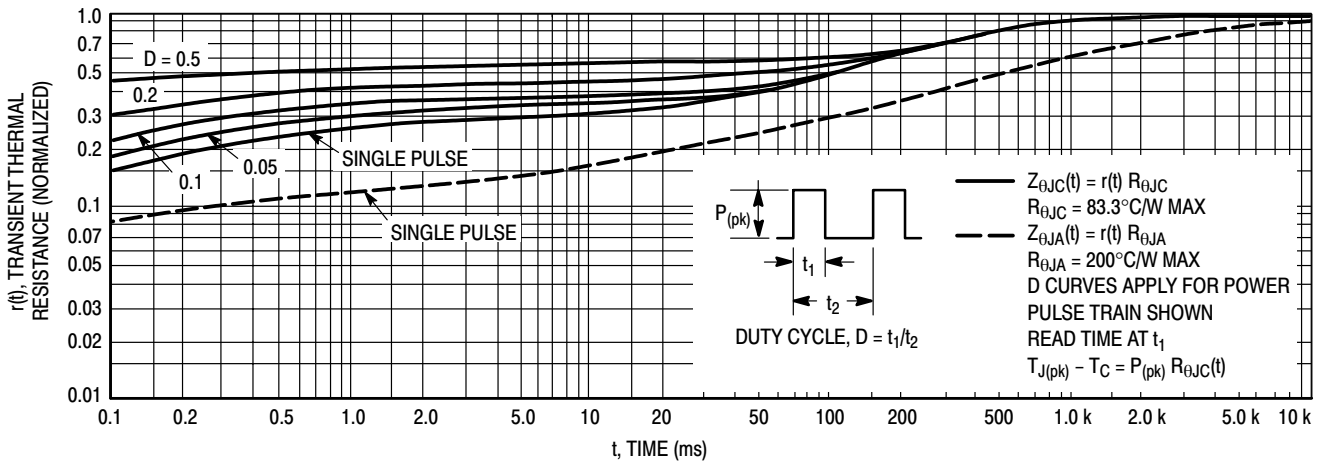

Figure 13. Thermal Response

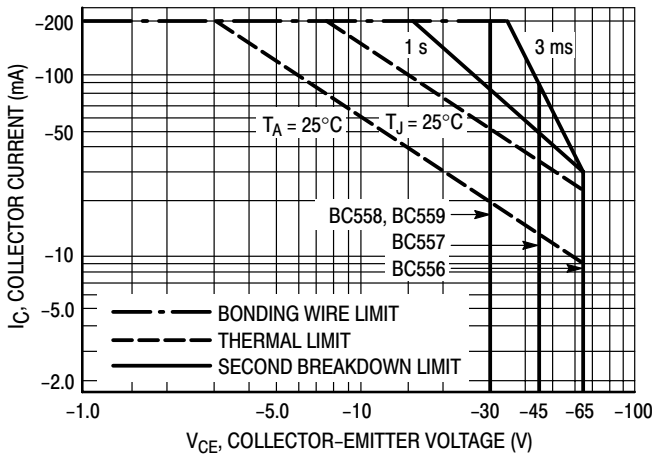

Figure 14. Active Region Safe Operating Area

The safe operating area curves indicate I_C - V_{CE} limits of the transistor that must be observed for reliable operation. Collector load lines for specific circuits must fall below the limits indicated by the applicable curve.

The data of Figure 14 is based upon $T_{J(pk)} = 150^\circ\text{C}$; T_C or T_A is variable depending upon conditions. Pulse curves are valid for duty cycles to 10% provided $T_{J(pk)} \leq 150^\circ\text{C}$. $T_{J(pk)}$ may be calculated from the data in Figure 13. At high case or ambient temperatures, thermal limitations will reduce the power that can be handled to values less than the limitations imposed by the secondary breakdown.

BC856ALT1 Series

ORDERING INFORMATION

Device	Marking	Package	Shipping†
BC856ALT1	3A	SOT-23	3,000 / Tape & Reel
BC856ALT3	3A	SOT-23	10,000 / Tape & Reel
BC856BLT1	3B	SOT-23	3,000 / Tape & Reel
BC856BLT1G	3B	SOT-23 (Pb-Free)	
BC856BLT3	3B	SOT-23	10,000 / Tape & Reel
BC857ALT1	3E	SOT-23	3,000 / Tape & Reel
BC857BLT1	3F	SOT-23	3,000 / Tape & Reel
BC857BLT3	3F	SOT-23	10,000 / Tape & Reel
BC857BLT3G	3F	SOT-23 (Pb-Free)	
BC857CLT1	3G	SOT-23	3,000 / Tape & Reel
BC857CLT1G	3G	SOT-23 (Pb-Free)	3,000 / Tape & Reel
BC858ALT1	3J	SOT-23	3,000 / Tape & Reel
BC858ALT1G	3J	SOT-23 (Pb-Free)	
BC858BLT1	3K	SOT-23	3,000 / Tape & Reel
BC858BLT1G	3K	SOT-23 (Pb-Free)	
BC858BLT3	3L	SOT-23	10,000 / Tape & Reel
BC858CLT1	3L	SOT-23	3,000 / Tape & Reel
BC858CLT1G	3L	SOT-23 (Pb-Free)	
BC858CLT3	3L	SOT-23	10,000 / Tape & Reel
BC858CLT3G	3L	SOT-23 (Pb-Free)	
BC859BLT1	4B	SOT-23	3,000 / Tape & Reel
BC859BLT3	4B	SOT-23	10,000 / Tape & Reel
BC859CLT1	4C	SOT-23	3,000 / Tape & Reel
BC859CLT3	4C	SOT-23	10,000 / Tape & Reel

†For information on tape and reel specifications, including part orientation and tape sizes, please refer to our Tape and Reel Packaging Specifications Brochure, BRD8011/D.

BC856ALT1 Series

PACKAGE DIMENSIONS

SOT-23 (TO-236)
CASE 318-09
ISSUE AI

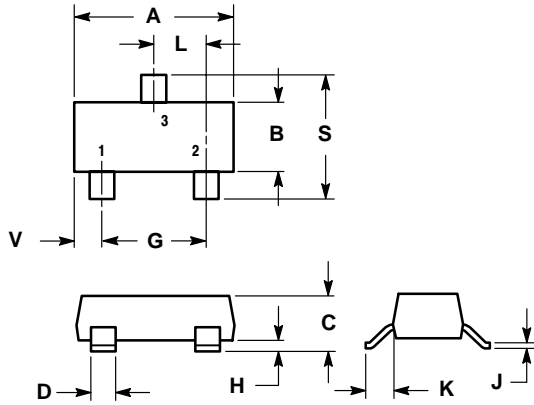

NOTES:

1. DIMENSIONING AND TOLERANCING PER ANSI Y14.5M, 1982.
2. CONTROLLING DIMENSION: INCH.
3. MAXIMUM LEAD THICKNESS INCLUDES LEAD FINISH THICKNESS. MINIMUM LEAD THICKNESS IS THE MINIMUM THICKNESS OF BASE MATERIAL.
4. 318-01, -02, AND -06 OBSOLETE, NEW STANDARD 318-09.

DIM	INCHES		MILLIMETERS	
	MIN	MAX	MIN	MAX
A	0.1102	0.1197	2.80	3.04
B	0.0472	0.0551	1.20	1.40
C	0.0385	0.0498	0.99	1.26
D	0.0140	0.0200	0.36	0.50
G	0.0670	0.0826	1.70	2.10
H	0.0040	0.0098	0.10	0.25
J	0.0034	0.0070	0.085	0.177
K	0.0180	0.0236	0.45	0.60
L	0.0350	0.0401	0.89	1.02
S	0.0830	0.0984	2.10	2.50
V	0.0177	0.0236	0.45	0.60

STYLE 6:

- PIN 1. BASE
2. EMITTER
3. COLLECTOR

SOLDERING FOOTPRINT*

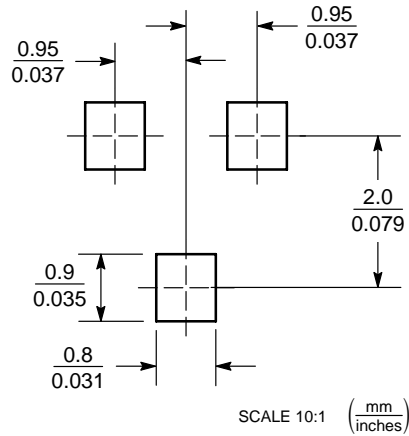

*For additional information on our Pb-Free strategy and soldering details, please download the ON Semiconductor Soldering and Mounting Techniques Reference Manual, SOLDERRM/D.

BC856ALT1 Series

ON Semiconductor and  are registered trademarks of Semiconductor Components Industries, LLC (SCILLC). SCILLC reserves the right to make changes without further notice to any products herein. SCILLC makes no warranty, representation or guarantee regarding the suitability of its products for any particular purpose, nor does SCILLC assume any liability arising out of the application or use of any product or circuit, and specifically disclaims any and all liability, including without limitation special, consequential or incidental damages. "Typical" parameters which may be provided in SCILLC data sheets and/or specifications can and do vary in different applications and actual performance may vary over time. All operating parameters, including "Typicals" must be validated for each customer application by customer's technical experts. SCILLC does not convey any license under its patent rights nor the rights of others. SCILLC products are not designed, intended, or authorized for use as components in systems intended for surgical implant into the body, or other applications intended to support or sustain life, or for any other application in which the failure of the SCILLC product could create a situation where personal injury or death may occur. Should Buyer purchase or use SCILLC products for any such unintended or unauthorized application, Buyer shall indemnify and hold SCILLC and its officers, employees, subsidiaries, affiliates, and distributors harmless against all claims, costs, damages, and expenses, and reasonable attorney fees arising out of, directly or indirectly, any claim of personal injury or death associated with such unintended or unauthorized use, even if such claim alleges that SCILLC was negligent regarding the design or manufacture of the part. SCILLC is an Equal Opportunity/Affirmative Action Employer. This literature is subject to all applicable copyright laws and is not for resale in any manner.

PUBLICATION ORDERING INFORMATION

LITERATURE FULFILLMENT:

Literature Distribution Center for ON Semiconductor
P.O. Box 61312, Phoenix, Arizona 85082-1312 USA

Phone: 480-829-7710 or 800-344-3860 Toll Free USA/Canada

Fax: 480-829-7709 or 800-344-3867 Toll Free USA/Canada

Email: orderlit@onsemi.com

N. American Technical Support: 800-282-9855 Toll Free
USA/Canada

Japan: ON Semiconductor, Japan Customer Focus Center
2-9-1 Kamimeguro, Meguro-ku, Tokyo, Japan 153-0051
Phone: 81-3-5773-3850

ON Semiconductor Website: <http://onsemi.com>

Order Literature: <http://www.onsemi.com/litorder>

For additional information, please contact your
local Sales Representative.



LittleDiode supplies new, hard to find or obsolete electronic components and semiconductors all over the world.

With over two million different components listed you are sure to find the part you need.

Feel free to visit us today at our online store:

LittleDiode.com

Looking forward to providing you with the best possible service.