

NPN Silicon RF Transistor

BFQ 29P

- For low-noise IF and broadband amplifiers up to 1 GHz at collector currents from 1 mA to 20 mA.
- CECC-type available: CECC 50002/258.

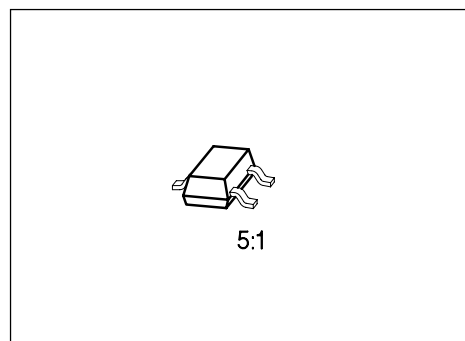

ESD: Electrostatic discharge sensitive device, observe handling precautions!

Type	Marking	Ordering Code (tape and reel)	Pin Configuration			Package ¹⁾
			1	2	3	
BFQ 29P	KC	Q62702-F659	B	E	C	SOT-23

Maximum Ratings

Parameter	Symbol	Values	Unit
Collector-emitter voltage	V_{CE0}	15	V
Collector-base voltage	V_{CB0}	20	
Emitter-base voltage	V_{EB0}	3	
Collector current	I_C	30	mA
Base current	I_B	4	
Total power dissipation, $T_s \leq 65 \text{ }^\circ\text{C}^3)$	P_{tot}	280	mW
Junction temperature	T_j	150	$^\circ\text{C}$
Ambient temperature range	T_A	- 65 ... + 150	
Storage temperature range	T_{stg}	- 65 ... + 150	

Thermal Resistance

Junction - ambient ²⁾	$R_{th JA}$	≤ 385	K/W
Junction - soldering point ³⁾	$R_{th JS}$	≤ 305	

1) For detailed dimensions see chapter Package Outlines.

2) Package mounted on alumina 15 mm × 16.7 mm × 0.7 mm.

3) T_s is measured on the collector lead at the soldering point to the pcb.

Electrical Characteristics

at $T_A = 25\text{ }^\circ\text{C}$, unless otherwise specified.

Parameter	Symbol	Values			Unit
		min.	typ.	max.	

DC Characteristics

Collector-emitter breakdown voltage $I_C = 1\text{ mA}$, $I_B = 0$	$V_{(BR)CE0}$	15	–	–	V
Collector-base cutoff current $V_{CB} = 10\text{ V}$, $I_E = 0$ $V_{CB} = 20\text{ V}$, $I_E = 0$	I_{CB0}	– –	– –	0.05 10	μA
Emitter-base cutoff current $V_{EB} = 3\text{ V}$, $I_C = 0$	I_{EB0}	–	–	100	μA
DC current gain $I_C = 3\text{ mA}$, $V_{CE} = 6\text{ V}$ $I_C = 10\text{ mA}$, $V_{CE} = 6\text{ V}$	h_{FE}	50 50	– 140	250 –	–
Collector-emitter saturation voltage $I_C = 20\text{ mA}$, $I_B = 1\text{ mA}$	V_{CEsat}	–	0.1	0.4	V

Electrical Characteristics

at $T_A = 25\text{ }^\circ\text{C}$, unless otherwise specified.

Parameter	Symbol	Values			Unit
		min.	typ.	max.	

AC Characteristics

Transition frequency $I_C = 3\text{ mA}$, $V_{CE} = 6\text{ V}$, $f = 200\text{ MHz}$ $I_C = 20\text{ mA}$, $V_{CE} = 6\text{ V}$, $f = 200\text{ MHz}$	f_t	– 3.6	2.7 5	– –	GHz
Collector-base capacitance $V_{CB} = 10\text{ V}$, $V_{BE} = v_{be} = 0$, $f = 1\text{ MHz}$	C_{cb}	–	0.5	0.65	pF
Collector-emitter capacitance $V_{CE} = 10\text{ V}$, $V_{BE} = v_{be} = 0$, $f = 1\text{ MHz}$	C_{ce}	–	0.28	–	
Input capacitance $V_{EB} = 0.5\text{ V}$, $I_C = i_c = 0$, $f = 1\text{ MHz}$	C_{ibo}	–	1.35	–	
Output capacitance $V_{CE} = 10\text{ V}$, $V_{BE} = v_{be} = 0$, $f = 1\text{ MHz}$	C_{obs}	–	0.8	–	
Noise figure $I_C = 3\text{ mA}$, $V_{CE} = 6\text{ V}$, $f = 10\text{ MHz}$, $Z_S = 75\text{ }\Omega$ $I_C = 4\text{ mA}$, $V_{CE} = 6\text{ V}$, $f = 800\text{ MHz}$, $Z_S = 50\text{ }\Omega$	F	– –	0.9 1.5	1.2 –	dB
Power gain $I_C = 20\text{ mA}$, $V_{CE} = 6\text{ V}$, $f = 800\text{ MHz}$, $Z_0 = 50\text{ }\Omega$, $Z_L = Z_{Lopt}$	G_{pe}	–	14	–	
Transducer gain $I_C = 20\text{ mA}$, $V_{CE} = 6\text{ V}$, $f = 1\text{ GHz}$, $Z_0 = 50\text{ }\Omega$	$ S_{21e} ^2$	–	11	–	
Linear output voltage two-tone intermodulation test $I_C = 20\text{ mA}$, $V_{CE} = 6\text{ V}$, $d_{IM} = 60\text{ dB}$, $f_1 = 806\text{ MHz}$, $f_2 = 810\text{ MHz}$, $Z_S = Z_L = 50\text{ }\Omega$	$V_{o1} = V_{o2}$	–	180	–	mV
Third order intercept point $I_C = 20\text{ mA}$, $V_{CE} = 6\text{ V}$, $f = 800\text{ MHz}$	IP_3	–	28	–	dBm

Total power dissipation $P_{tot} = f(T_A^*; T_S)$

*Package mounted on alumina

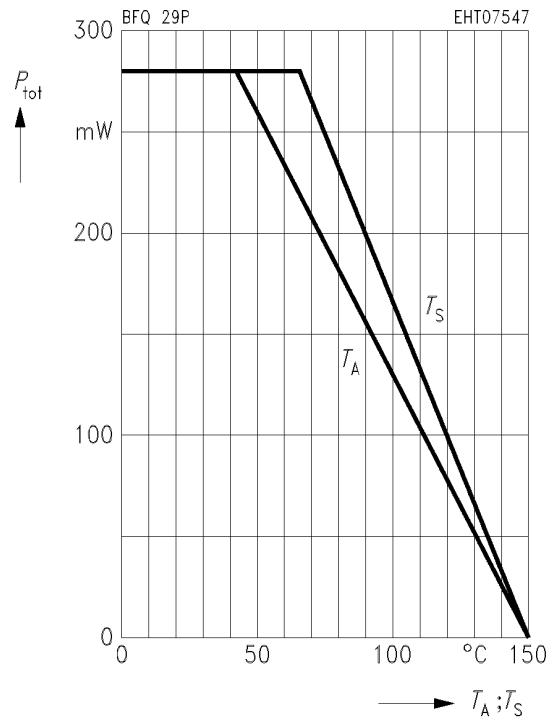

Transition frequency $f_T = f(I_C)$

$V_{CE} = 6 \text{ V}, f = 200 \text{ MHz}$

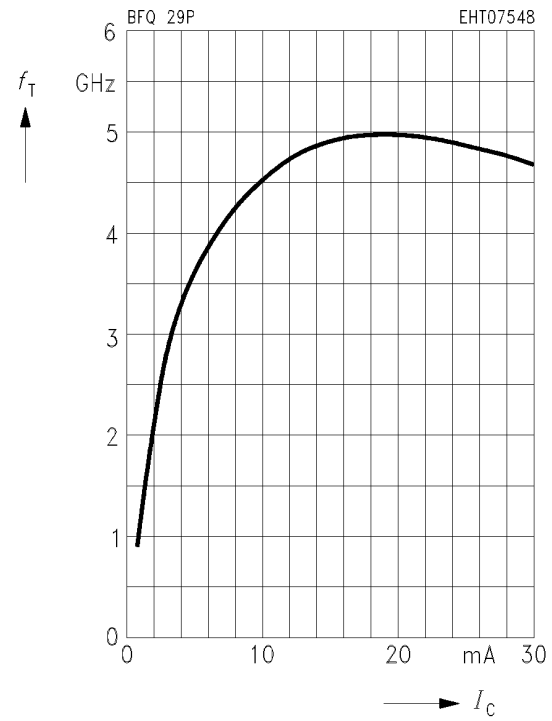

Collector-base capacitance $C_{cb} = f(V_{CB})$

$V_{BE} = v_{be} = 0, f = 1 \text{ MHz}$

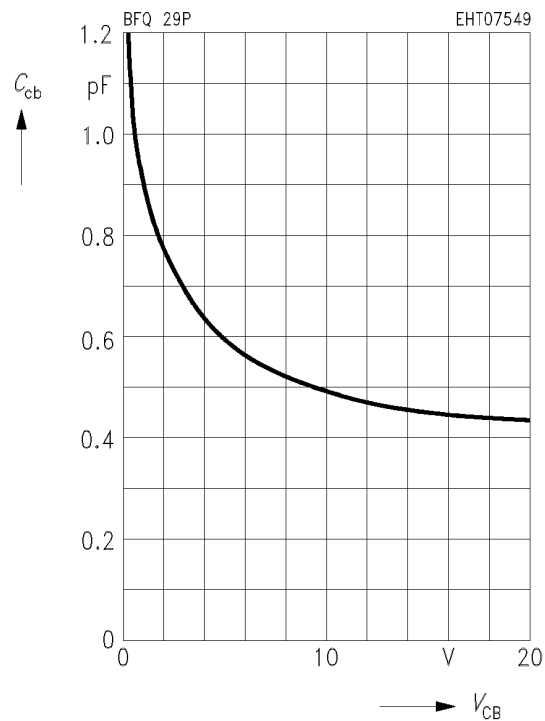

Common Emitter Noise Parameters

f GHz	F_{min} dB	$G_p(F_{min})$ dB	Γ_{opt}		R_N Ω	N -	$F_{50\Omega}$ dB	$G_p(F_{50\Omega})$ dB
			MAG	ANG				

$I_C = 3\text{ mA}, V_{CE} = 6\text{ V}, Z_0 = 50\ \Omega$

0.01	0.85	-	(Z _s = 130 Ω)		-	-	1.2	-
------	------	---	----------------------------------	--	---	---	-----	---

$I_C = 5\text{ mA}, V_{CE} = 6\text{ V}, Z_0 = 50\ \Omega$

0.01	0.85	-	(Z _s = 100 Ω)		-	-	1.1	-
0.8	1.25	13	0.25	93.5	11.1	0.20	1.45	14

Noise figure $F = f(Z_s)$

$V_{CE} = 6\text{ V}, f = 10\text{ MHz}$

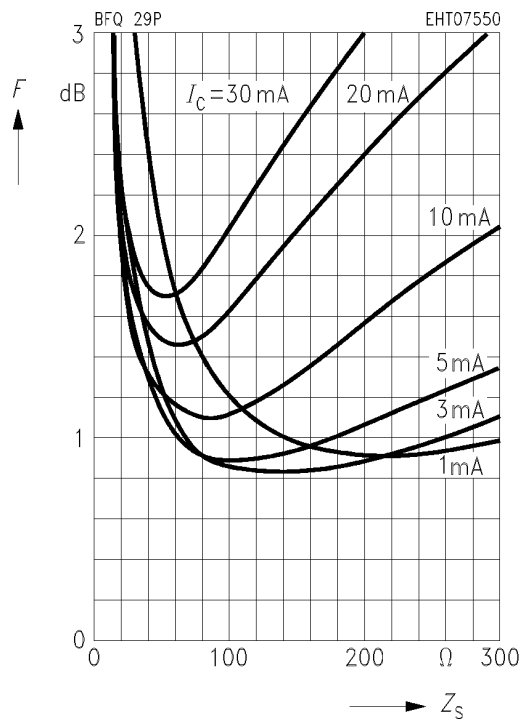

Circles of constant noise figure $F = f(Z_s)$
 in Z_s -plane, $I_C = 5 \text{ mA}$, $V_{CE} = 6 \text{ V}$, $f = 800 \text{ MHz}$

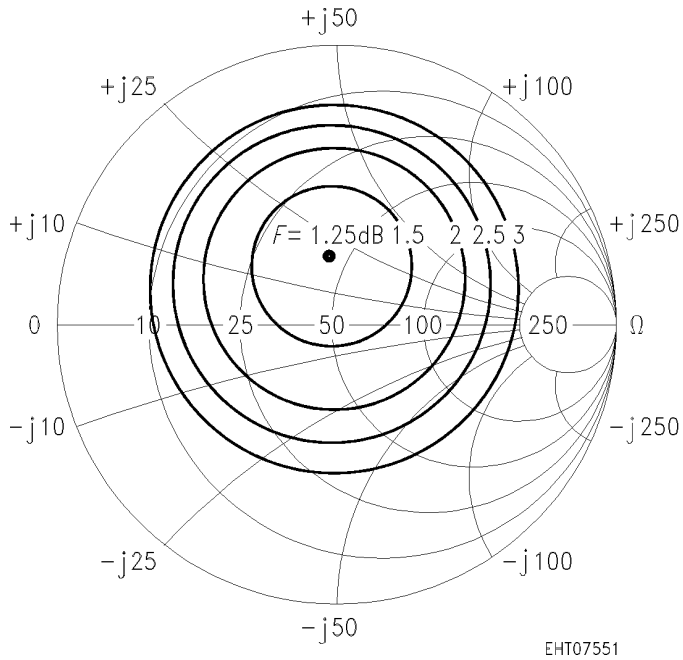

Noise figure $F = f(I_C)$
 $V_{CE} = 6 \text{ V}$, $f = 800 \text{ MHz}$, $Z_{Lopt} (G)$

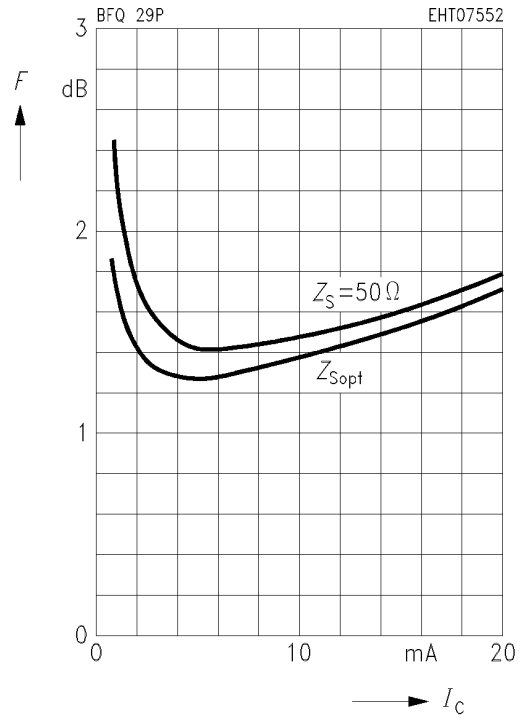

Common Emitter S Parameters

f	S_{11}		S_{21}		S_{12}		S_{22}	
	MAG	ANG	MAG	ANG	MAG	ANG	MAG	ANG
0.1	0.93	- 20	6.76	158	0.03	76	0.97	- 7
0.2	0.86	- 45	6.42	144	0.06	65	0.89	- 17
0.3	0.79	- 62	5.16	133	0.08	57	0.85	- 23
0.5	0.66	- 93	4.19	113	0.11	47	0.73	- 29
0.8	0.50	- 129	2.99	92	0.11	41	0.62	- 33
1.0	0.47	- 147	2.48	82	0.12	41	0.59	- 35
1.2	0.45	- 161	2.11	74	0.13	42	0.57	- 37
1.5	0.43	179	1.78	63	0.14	47	0.55	- 40
1.8	0.45	159	1.51	54	0.16	52	0.54	- 46
2.0	0.46	149	1.42	48	0.17	56	0.52	- 48

$I_C = 2 \text{ mA}, V_{CE} = 6 \text{ V}, Z_0 = 50 \Omega$

$S_{11}, S_{22} = f(f)$
 $I_C = 2 \text{ mA}, V_{CE} = 6 \text{ V}, Z_0 = 50 \Omega$

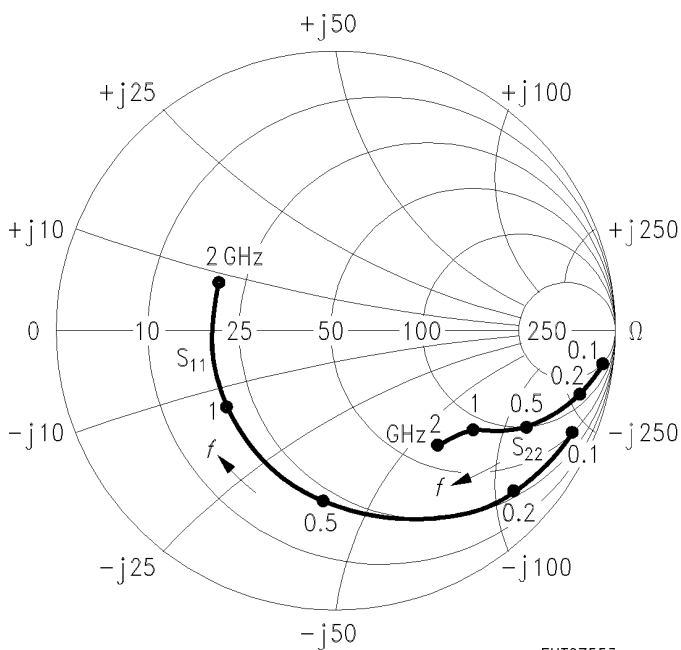

EHT07553

$S_{12}, S_{21} = f(f)$
 $I_C = 2 \text{ mA}, V_{CE} = 6 \text{ V}, Z_0 = 50 \Omega$

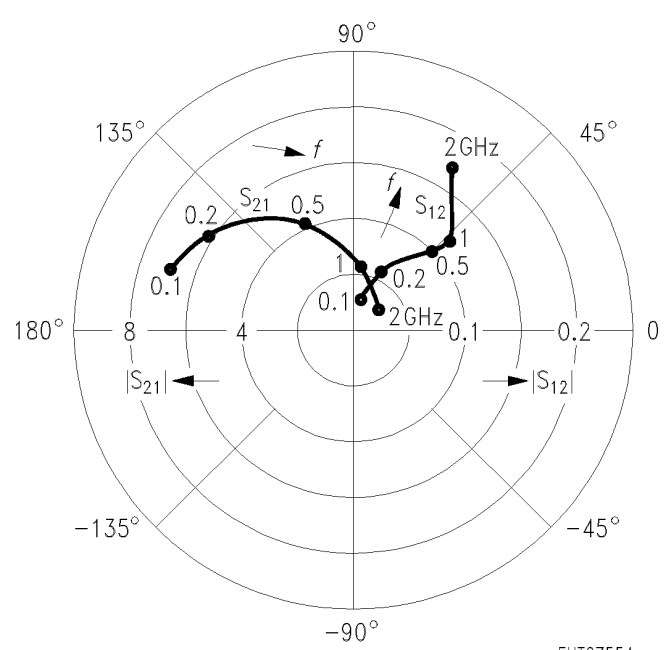

EHT07554

Common Emitter S Parameters (continued)

<i>f</i>	<i>S</i> ₁₁		<i>S</i> ₂₁		<i>S</i> ₁₂		<i>S</i> ₂₂	
	MAG	ANG	MAG	ANG	MAG	ANG	MAG	ANG
0.1	0.80	- 31	13.96	147	0.03	72	0.89	- 13
0.2	0.69	- 66	11.55	129	0.05	60	0.76	- 28
0.3	0.57	- 84	8.56	119	0.06	55	0.68	- 31
0.5	0.46	- 118	6.06	102	0.08	53	0.54	- 34
0.8	0.35	- 152	4.00	85	0.10	55	0.46	- 33
1.0	0.34	- 167	3.25	77	0.12	57	0.45	- 35
1.2	0.34	- 180	2.74	71	0.13	58	0.43	- 36
1.5	0.34	164	2.28	61	0.16	59	0.42	- 39
1.8	0.36	148	1.94	54	0.19	60	0.41	- 44
2.0	0.37	139	1.80	49	0.20	60	0.39	- 44

*I*_C = 5 mA, *V*_{CE} = 6 V, *Z*₀ = 50 Ω

*S*₁₁, *S*₂₂ = *f*(*f*)

*I*_C = 5 mA, *V*_{CE} = 6 V, *Z*₀ = 50 Ω

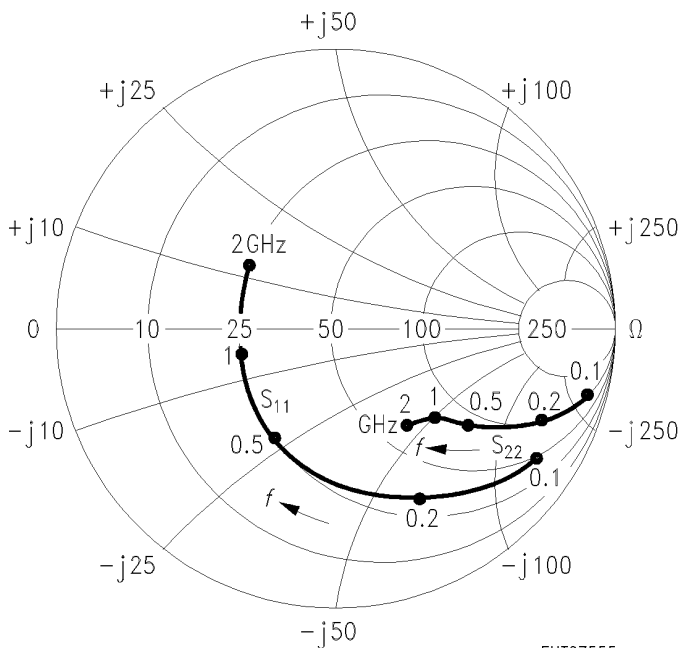

EHT07555

*S*₁₂, *S*₂₁ = *f*(*f*)

*I*_C = 5 mA, *V*_{CE} = 6 V, *Z*₀ = 50 Ω

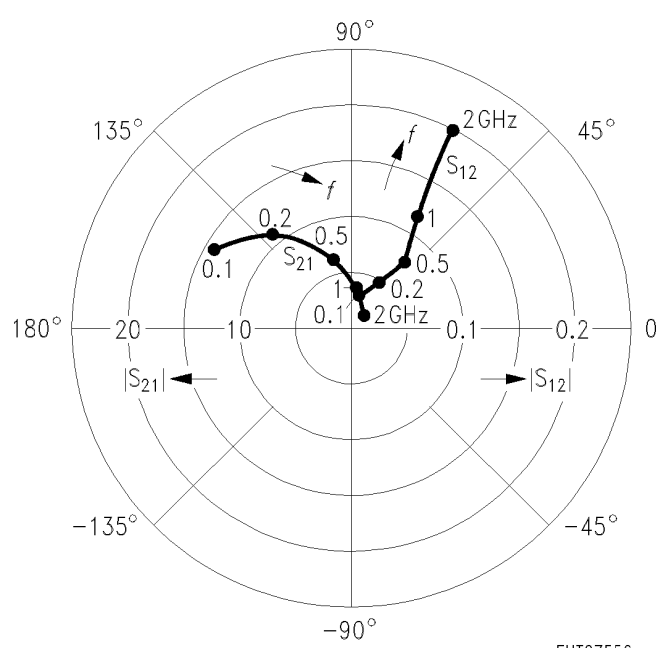

EHT07556

Common Emitter S Parameters (continued)

f	S_{11}		S_{21}		S_{12}		S_{22}	
	MAG	ANG	MAG	ANG	MAG	ANG	MAG	ANG
0.1	0.65	- 46	20.65	135	0.03	69	0.79	- 18
0.2	0.53	- 87	14.88	117	0.04	58	0.61	- 32
0.3	0.42	- 104	10.41	108	0.05	59	0.54	- 33
0.5	0.35	- 137	6.92	94	0.07	61	0.43	- 33
0.8	0.29	- 169	4.47	80	0.10	63	0.39	- 30
1.0	0.30	179	3.59	74	0.12	65	0.38	- 32
1.2	0.30	169	3.04	69	0.14	64	0.36	- 34
1.5	0.30	155	2.50	60	0.17	63	0.36	- 36
1.8	0.33	141	2.11	53	0.20	62	0.35	- 41
2.0	0.35	133	1.97	49	0.22	62	0.33	- 42

$I_C = 10 \text{ mA}$, $V_{CE} = 6 \text{ V}$, $Z_0 = 50 \Omega$

$S_{11}, S_{22} = f(f)$

$I_C = 10 \text{ mA}$, $V_{CE} = 6 \text{ V}$, $Z_0 = 50 \Omega$

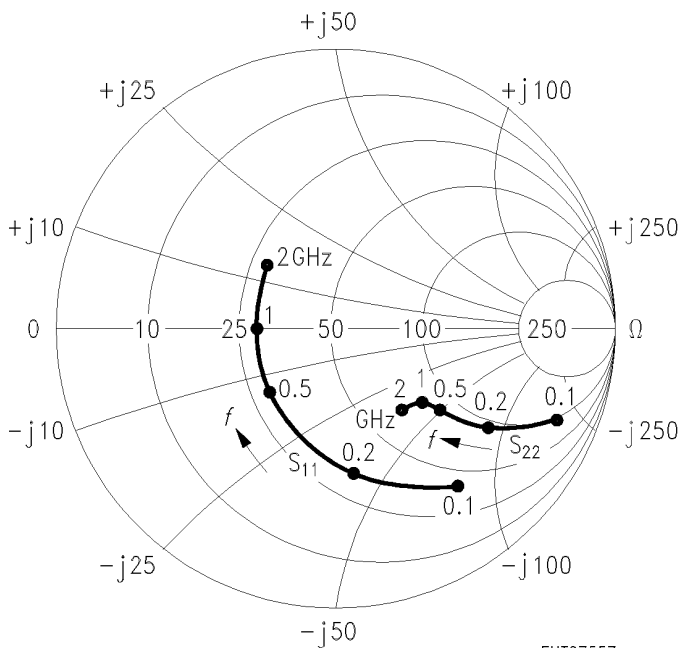

EHT07557

$S_{12}, S_{21} = f(f)$

$I_C = 10 \text{ mA}$, $V_{CE} = 6 \text{ V}$, $Z_0 = 50 \Omega$

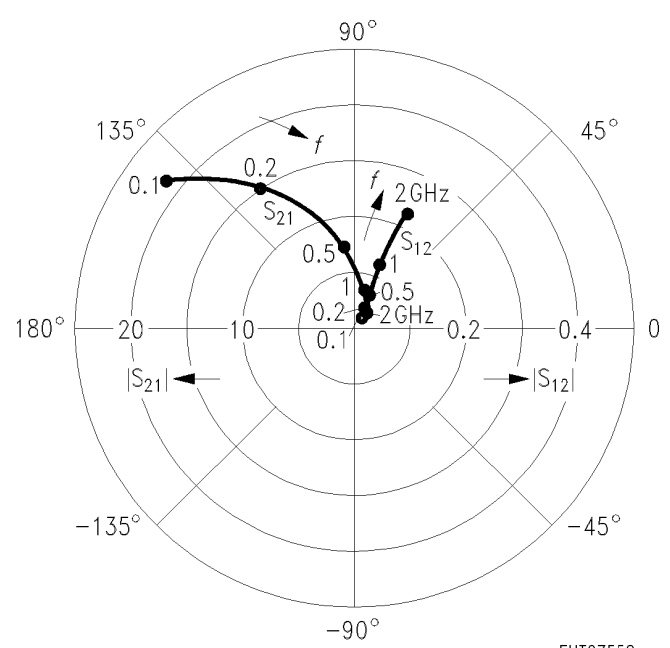

EHT07558

Common Emitter S Parameters (continued)

<i>f</i>	<i>S</i> ₁₁		<i>S</i> ₂₁		<i>S</i> ₁₂		<i>S</i> ₂₂	
	MAG	ANG	MAG	ANG	MAG	ANG	MAG	ANG
0.1	0.47	- 64	25.26	126	0.02	67	0.69	- 21
0.2	0.40	- 108	16.60	109	0.03	62	0.50	- 32
0.3	0.33	- 125	11.22	102	0.04	65	0.46	- 30
0.5	0.31	- 154	7.16	89	0.06	68	0.39	- 28
0.8	0.28	178	4.57	77	0.09	68	0.36	- 26
1.0	0.29	169	3.65	72	0.12	69	0.36	- 28
1.2	0.30	161	3.09	67	0.14	68	0.35	- 30
1.5	0.30	148	2.54	59	0.17	66	0.34	- 33
1.8	0.33	135	2.15	52	0.21	64	0.34	- 39
2.0	0.35	128	2.00	48	0.22	63	0.32	- 39

$I_C = 20 \text{ mA}, V_{CE} = 6 \text{ V}, Z_0 = 50 \Omega$

$S_{11}, S_{22} = f(f)$

$I_C = 20 \text{ mA}, V_{CE} = 6 \text{ V}, Z_0 = 50 \Omega$

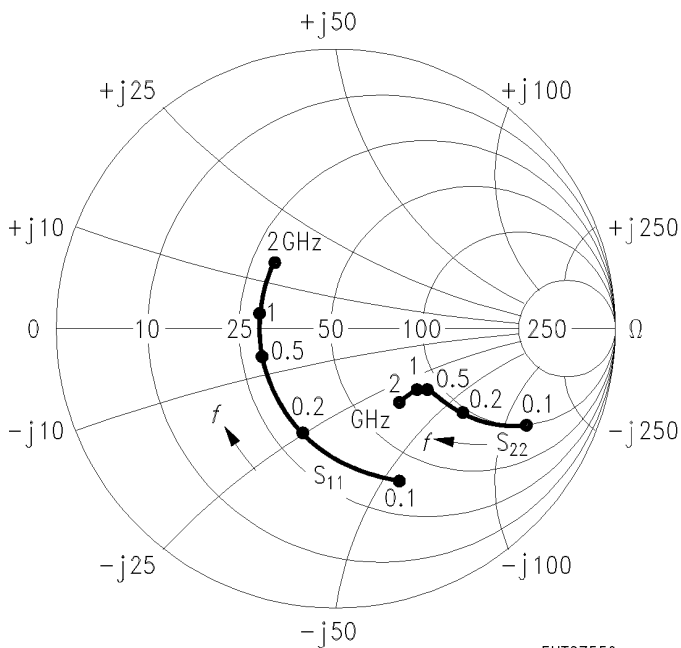

EHT07559

$S_{12}, S_{21} = f(f)$

$I_C = 20 \text{ mA}, V_{CE} = 6 \text{ V}, Z_0 = 50 \Omega$

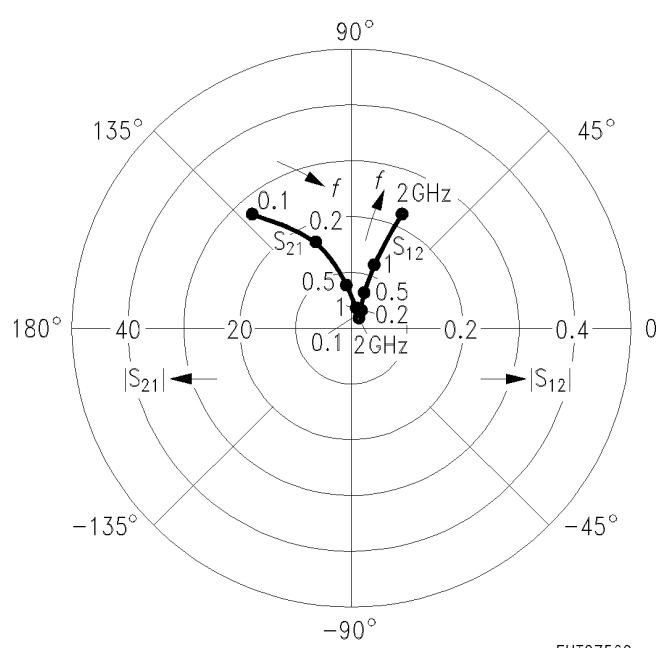

EHT07560

This datasheet has been downloaded from:

www.DatasheetCatalog.com

Datasheets for electronic components.



LittleDiode supplies new, hard to find or obsolete electronic components and semiconductors all over the world.

With over two million different components listed you are sure to find the part you need.

Feel free to visit us today at our online store:

LittleDiode.com

Looking forward to providing you with the best possible service.