

Silicon NPN Planar RF Transistor

Electrostatic sensitive device.
Observe precautions for handling.



Applications

RF amplifier up to GHz range specially for wide band antenna amplifier.

Features

- High power gain
- Low noise figure
- High transition frequency

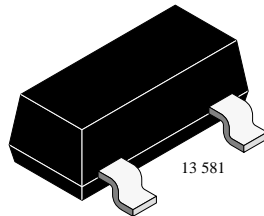
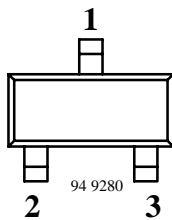

BFR93 Marking: R1
Plastic case (SOT 23)
1 = Collector, 2 = Base, 3 = Emitter

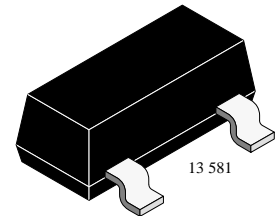
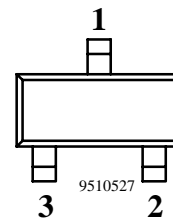

BFR93R Marking: R4
Plastic case (SOT 23)
1 = Collector, 2 = Base, 3 = Emitter

Absolute Maximum Ratings

$T_{amb} = 25^{\circ}\text{C}$, unless otherwise specified

Parameter	Test Conditions	Symbol	Value	Unit
Collector-base voltage		V_{CBO}	20	V
Collector-emitter voltage		V_{CEO}	12	V
Emitter-base voltage		V_{EBO}	2	V
Collector current		I_C	40	mA
Total power dissipation	$T_{amb} \leq 60^{\circ}\text{C}$	P_{tot}	200	mW
Junction temperature		T_j	150	$^{\circ}\text{C}$
Storage temperature range		T_{stg}	-65 to +150	$^{\circ}\text{C}$

Maximum Thermal Resistance

$T_{amb} = 25^{\circ}\text{C}$, unless otherwise specified

Parameter	Test Conditions	Symbol	Value	Unit
Junction ambient	on glass fibre printed board (25 x 20 x 1.5) mm ³ plated with 35 μm Cu	R_{thJA}	450	K/W

Electrical DC Characteristics

$T_{amb} = 25^{\circ}\text{C}$, unless otherwise specified

Parameter	Test Conditions	Symbol	Min	Typ	Max	Unit
Collector cut-off current	$V_{CE} = 20\text{ V}, V_{BE} = 0$	I_{CES}			100	μA
Collector-base cut-off current	$V_{CB} = 10\text{ V}, I_E = 0$	I_{CBO}			100	nA
Emitter-base cut-off current	$V_{EB} = 2\text{ V}, I_C = 0$	I_{EBO}			10	μA
Collector-emitter breakdown voltage	$I_C = 1\text{ mA}, I_B = 0$	$V_{(BR)CEO}$	12			V
DC forward current transfer ratio	$V_{CE} = 5\text{ V}, I_C = 30\text{ mA}$	h_{FE}	25	50	150	

Electrical AC Characteristics

$T_{amb} = 25^{\circ}\text{C}$, unless otherwise specified

Parameter	Test Conditions	Symbol	Min	Typ	Max	Unit
Transition frequency	$V_{CE} = 5\text{ V}, I_C = 30\text{ mA}, f = 500\text{ MHz}$	f_T		5		GHz
Collector-base capacitance	$V_{CB} = 5\text{ V}, f = 1\text{ MHz}$	C_{cb}		0.5		pF
Collector-emitter capacitance	$V_{CE} = 10\text{ V}, f = 1\text{ MHz}$	C_{ce}		0.15		pF
Emitter-base capacitance	$V_{EB} = 0.5\text{ V}, f = 1\text{ MHz}$	C_{eb}		1.1		pF
Noise figure	$V_{CE} = 5\text{ V}, I_C = 4\text{ mA}, Z_S = 50\ \Omega,$ $f = 500\text{ MHz}$	F		1.9		dB
Power gain	$V_{CE} = 5\text{ V}, I_C = 30\text{ mA}, Z_L = Z_{Lopt},$ $f = 500\text{ MHz}$	G_{pe}		18		dB
	$V_{CE} = 5\text{ V}, I_C = 30\text{ mA}, Z_L = Z_{Lopt},$ $f = 800\text{ MHz}$	G_{pe}		13		dB
Linear output voltage – two tone intermodulation test	$V_{CE} = 5\text{ V}, I_C = 30\text{ mA}, d_{IM} = 60\text{ dB},$ $f_1 = 806\text{ MHz}, f_2 = 810\text{ MHz},$ $Z_S = Z_L = 50\ \Omega$	$V_1 = V_2$		240		mV
Third order intercept point	$V_{CE} = 5\text{ V}, I_C = 30\text{ mA}, f = 800\text{ MHz}$	IP_3		30		dBm



Common Emitter S-Parameters

$Z_0 = 50 \Omega$, $T_{amb} = 25^\circ C$, unless otherwise specified

V_{CE}/V	I_C/mA	f/MHz	S11		S21		S12		S22	
			LIN MAG	ANG	LIN MAG	ANG	LIN MAG	ANG	LIN MAG	ANG
				deg		deg		deg		deg
5	5	100	0.731	-41.1	12.40	148.2	0.031	70.1	0.891	-17.4
		300	0.474	-98.0	7.54	112.4	0.061	55.9	0.618	-28.8
		500	0.358	-132.7	5.00	95.7	0.078	55.9	0.504	-27.6
		800	0.301	-166.0	3.30	81.1	0.104	59.6	0.458	-24.5
		1000	0.293	179.5	2.71	73.8	0.123	61.2	0.460	-25.5
		1200	0.299	167.4	2.33	67.0	0.143	61.8	0.457	-28.5
		1500	0.328	152.7	1.93	57.7	0.173	62.0	0.442	-34.0
		1800	0.360	138.0	1.67	49.8	0.204	61.5	0.430	-38.4
	2000	0.381	130.1	1.54	45.1	0.227	60.6	0.427	-42.5	
	10	100	0.572	-56.5	18.26	137.6	0.026	68.0	0.796	-23.6
		300	0.344	-117.2	9.02	103.8	0.051	62.0	0.499	-29.7
		500	0.286	-151.4	5.72	90.4	0.073	64.7	0.413	-25.5
		800	0.259	178.7	3.69	78.1	0.106	66.7	0.392	-21.2
		1000	0.258	167.3	3.02	71.6	0.130	66.8	0.400	-22.2
		1200	0.265	157.5	2.58	65.5	0.152	66.0	0.400	-25.6
		1500	0.296	146.7	2.13	57.0	0.186	64.3	0.387	-31.3
		1800	0.327	133.7	1.84	49.5	0.220	62.3	0.374	-35.9
	2000	0.350	126.2	1.70	44.8	0.243	60.5	0.371	-40.1	
	20	100	0.423	-73.5	22.83	127.4	0.022	67.3	0.688	-28.0
		300	0.272	-134.6	9.73	98.0	0.047	68.3	0.422	-28.1
		500	0.250	-165.9	6.04	86.8	0.072	70.5	0.361	-22.3
		800	0.245	168.7	3.88	75.9	0.109	70.4	0.356	-17.9
		1000	0.241	158.9	3.15	69.8	0.134	69.3	0.368	-19.5
		1200	0.252	152.0	2.69	63.9	0.158	67.7	0.369	-23.5
		1500	0.286	143.2	2.22	55.8	0.193	65.0	0.355	-29.6
		1800	0.317	130.9	1.90	48.5	0.228	62.4	0.343	-34.1
	2000	0.342	123.6	1.75	44.0	0.252	60.2	0.340	-38.5	
	30	100	0.357	-84.4	24.36	122.1	0.021	68.1	0.629	-29.4
300		0.254	-144.3	9.78	95.5	0.046	71.2	0.393	-26.0	
500		0.248	-171.9	6.04	85.2	0.072	72.6	0.346	-20.0	
800		0.245	164.9	3.86	74.7	0.110	71.5	0.347	-16.1	
1000		0.247	156.3	3.14	68.7	0.136	70.1	0.360	-18.2	
1200		0.255	150.3	2.67	63.0	0.160	68.2	0.362	-22.5	
1500		0.292	141.9	2.20	55.1	0.195	65.5	0.347	-28.6	
1800		0.325	130.3	1.89	47.9	0.230	62.5	0.337	-33.5	
2000	0.349	123.6	1.74	43.1	0.254	60.3	0.333	-38.0		

Typical Characteristics ($T_{amb} = 25^{\circ}\text{C}$ unless otherwise specified)

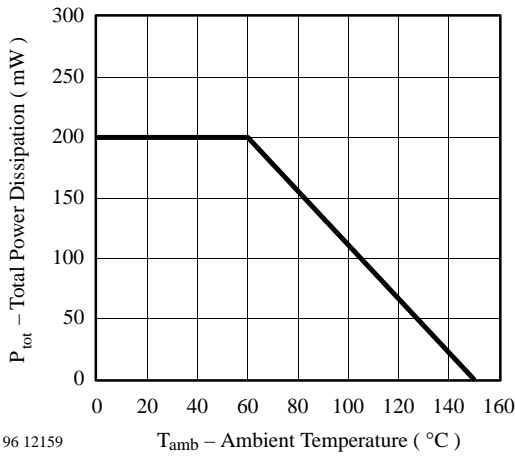

Figure 1. Total Power Dissipation vs. Ambient Temperature

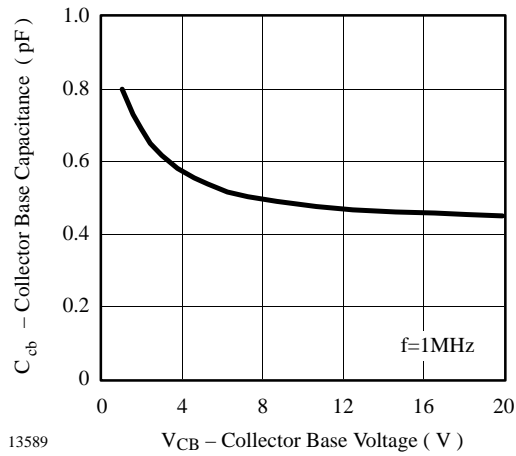

Figure 3. Collector Base Capacitance vs. Collector Base Voltage

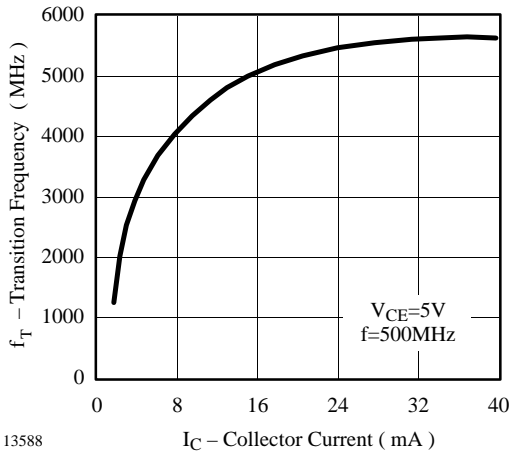

Figure 2. Transition Frequency vs. Collector Current

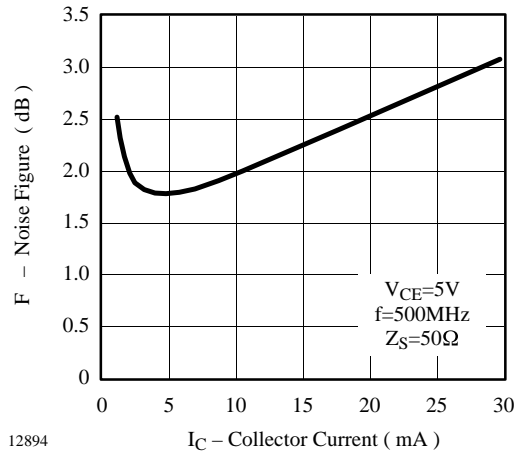

Figure 4. Noise Figure vs. Collector Current

$V_{CE} = 5 \text{ V}$, $I_C = 30 \text{ mA}$, $Z_0 = 50 \Omega$

S_{11}

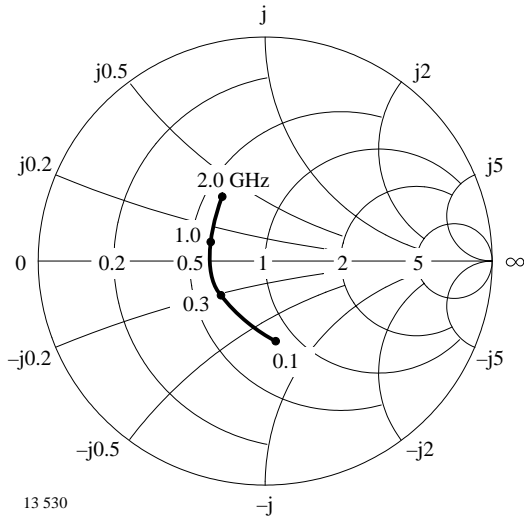

Figure 5. Input reflection coefficient

S_{12}

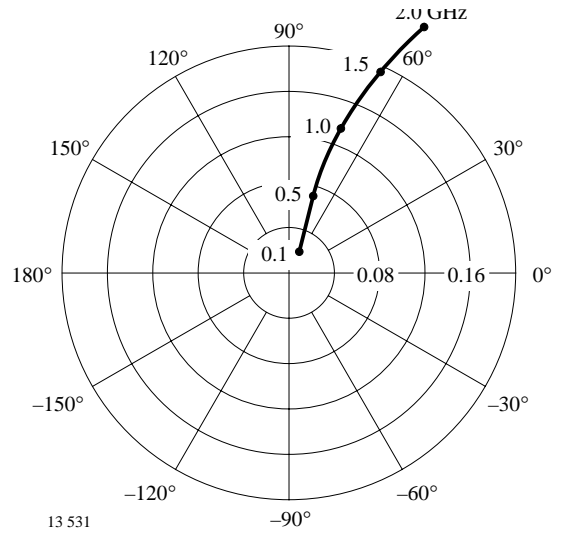

Figure 7. Reverse transmission coefficient

S_{21}

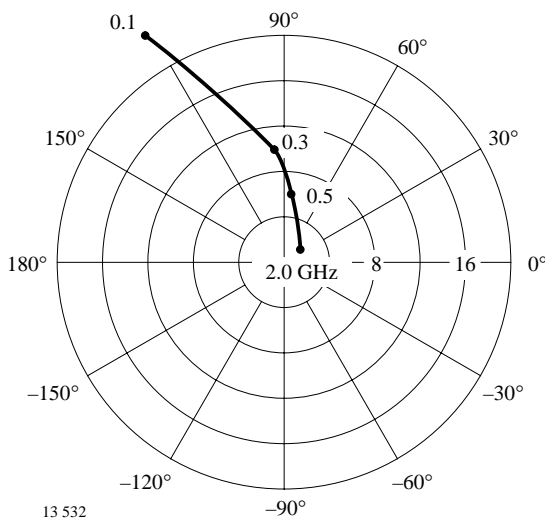

Figure 6. Forward transmission coefficient

S_{22}

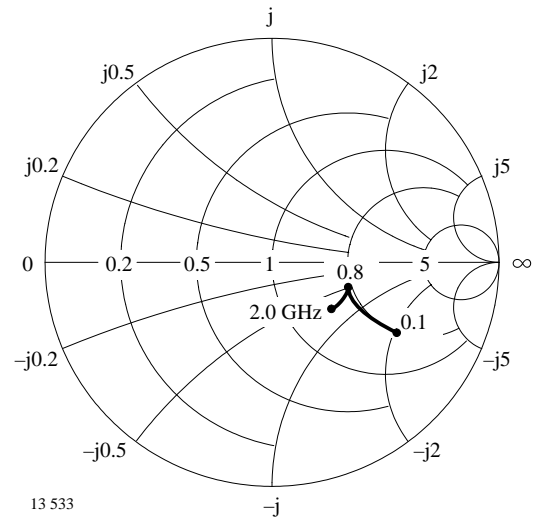
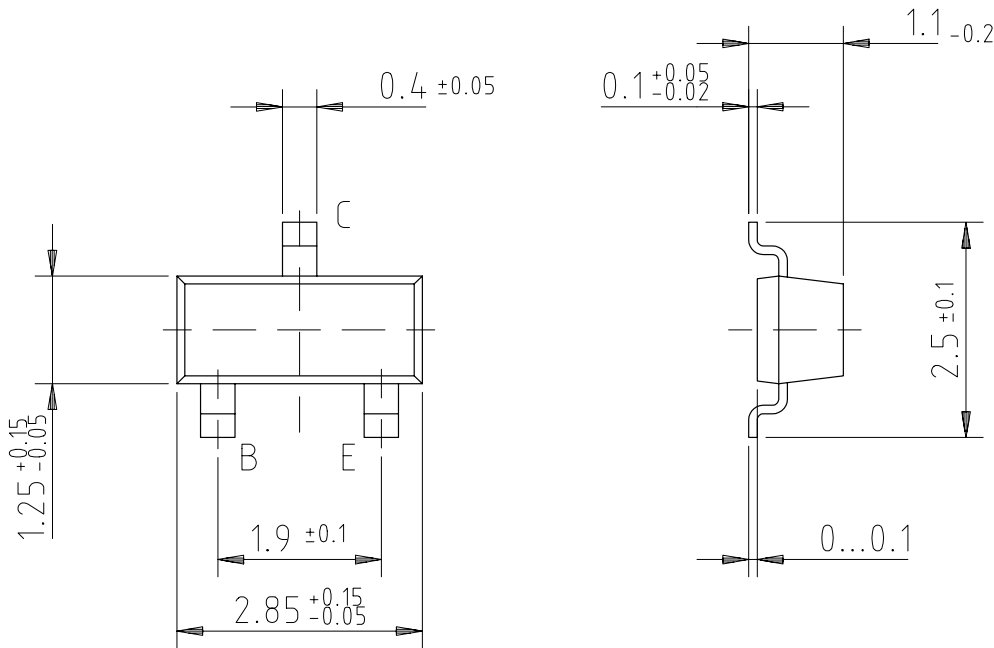
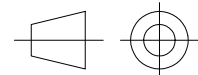

Figure 8. Output reflection coefficient

Dimensions of BFR93 in mm



95 11346



technical drawings
according to DIN
specifications

Dimensions of BFR93R in mm

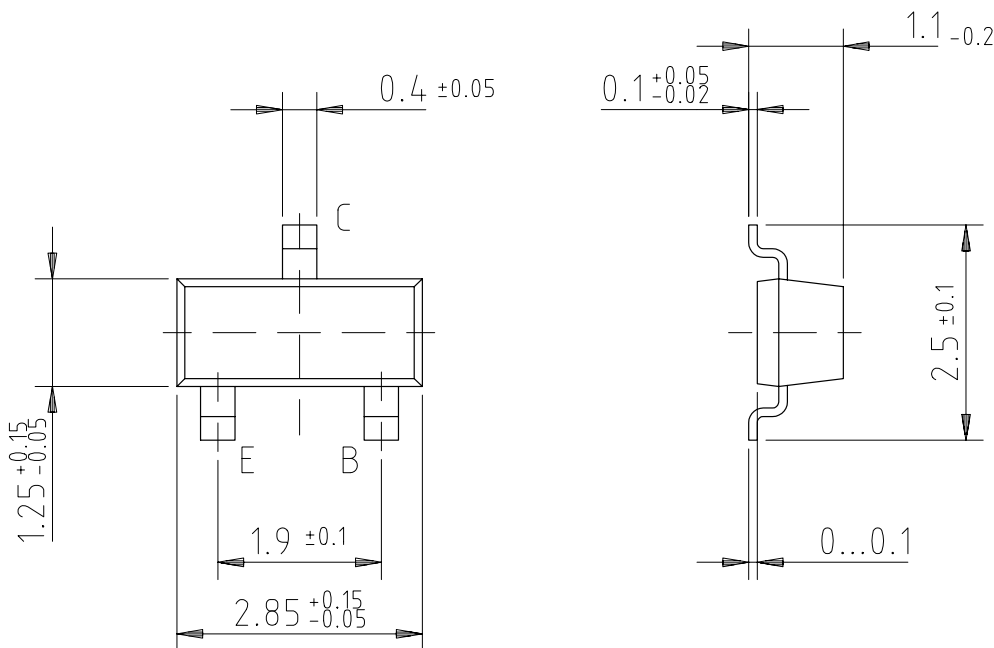

95 11347

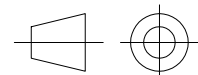

technical drawings
according to DIN
specifications



Ozone Depleting Substances Policy Statement

It is the policy of **Vishay Semiconductor GmbH** to

1. Meet all present and future national and international statutory requirements.
2. Regularly and continuously improve the performance of our products, processes, distribution and operating systems with respect to their impact on the health and safety of our employees and the public, as well as their impact on the environment.

It is particular concern to control or eliminate releases of those substances into the atmosphere which are known as ozone depleting substances (ODSs).

The Montreal Protocol (1987) and its London Amendments (1990) intend to severely restrict the use of ODSs and forbid their use within the next ten years. Various national and international initiatives are pressing for an earlier ban on these substances.

Vishay Semiconductor GmbH has been able to use its policy of continuous improvements to eliminate the use of ODSs listed in the following documents.

1. Annex A, B and list of transitional substances of the Montreal Protocol and the London Amendments respectively
2. Class I and II ozone depleting substances in the Clean Air Act Amendments of 1990 by the Environmental Protection Agency (EPA) in the USA
3. Council Decision 88/540/EEC and 91/690/EEC Annex A, B and C (transitional substances) respectively.

Vishay Semiconductor GmbH can certify that our semiconductors are not manufactured with ozone depleting substances and do not contain such substances.

We reserve the right to make changes to improve technical design and may do so without further notice.

Parameters can vary in different applications. All operating parameters must be validated for each customer application by the customer. Should the buyer use Vishay-Telefunken products for any unintended or unauthorized application, the buyer shall indemnify Vishay-Telefunken against all claims, costs, damages, and expenses, arising out of, directly or indirectly, any claim of personal damage, injury or death associated with such unintended or unauthorized use.

Vishay Semiconductor GmbH, P.O.B. 3535, D-74025 Heilbronn, Germany
Telephone: 49 (0) 7131 67 2831, Fax number: 49 (0) 7131 67 2423

This datasheet has been downloaded from:

www.DatasheetCatalog.com

Datasheets for electronic components.



LittleDiode supplies new, hard to find or obsolete electronic components and semiconductors all over the world.

With over two million different components listed you are sure to find the part you need.

Feel free to visit us today at our online store:

LittleDiode.com

Looking forward to providing you with the best possible service.