

VHF POWER AMPLIFIER MODULES

A range of broadband amplifier modules designed for mobile communications equipments, operating directly from 12 V vehicle electrical systems. The devices will produce 18 W output into a 50 Ω load. The modules consist of a two stage RF amplifier using npn transistor chips, together with lumped-element matching components.

QUICK REFERENCE DATA

type number	mode of operation	frequency range f (MHz)	nominal supply voltages $V_{B1} = V_{B2}$ (V)	drive power P_D (mW)	load power P_L (W)	nominal input impedance z_i (Ω)	nominal load impedance Z_L (Ω)
BGY32	cw	68 to 88	12.5	100	> 18 typ 23	50	50
BGY33	cw	80 to 108	12.5	100	> 18 typ 22	50	50
BGY35	cw	132 to 156	12.5	150	> 18 typ 22	50	50
BGY36	cw	148 to 174	12.5	150	> 18 typ 21	50	50

CIRCUIT DIAGRAM

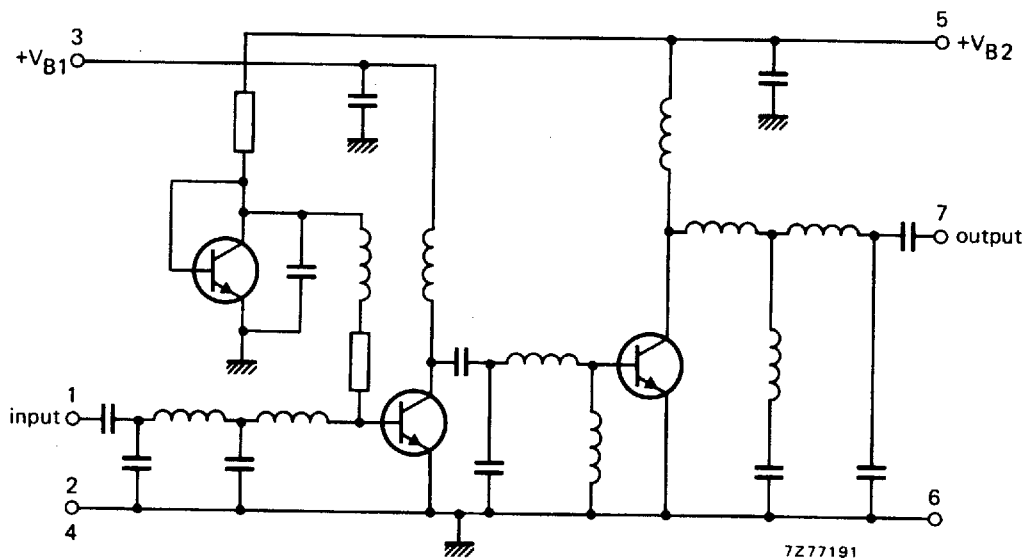

PRODUCT SAFETY This device incorporates beryllium oxide, the dust of which is toxic. The device is entirely safe provided that the BeO disc is not damaged.

MECHANICAL DATA

Fig. 1 SOT132B.

Dimensions in mm

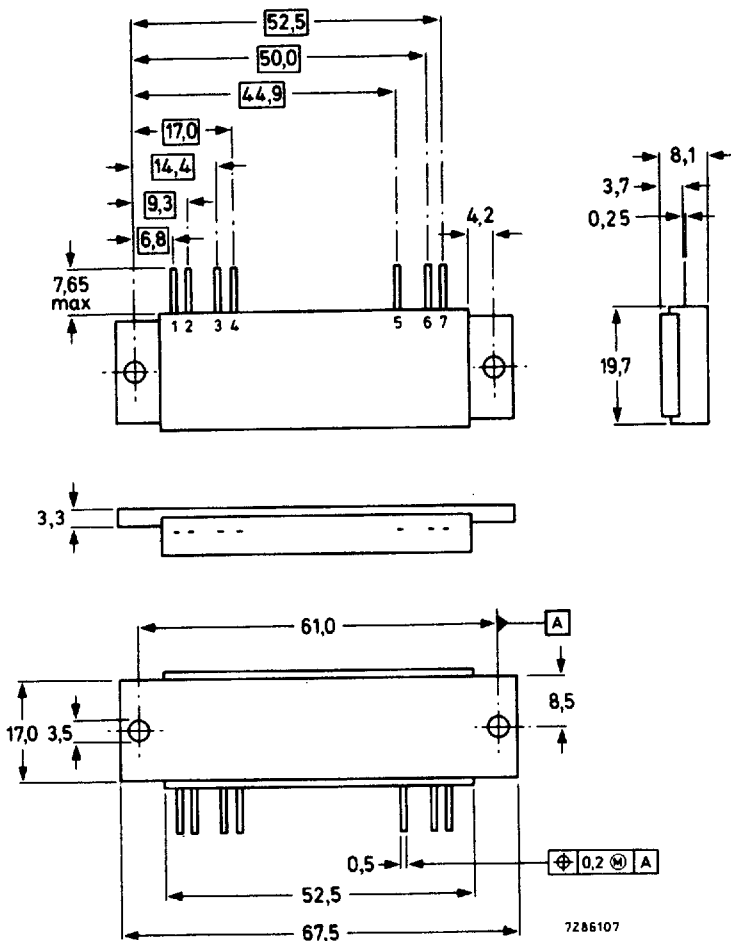

Lead reference

- 1 = Input
- 2 = Earth
- 3 = Supply +V_{B1}
- 4 = Earth
- 5 = Supply +V_{B2}
- 6 = Earth
- 7 = Output

Mounting and soldering recommendations

To ensure good thermal transfer the module should be mounted using heatsink compound onto a heatsink with a flat surface; if an isolation washer is used heatsink compound should be used on both sides of the insulator. Burrs and thickening of the holes in the heatsink should be removed and 3 mm bolts tightened to torques of 0,5 Nm minimum.

Devices may be soldered directly into a circuit with a soldering iron at maximum iron temperature of 245 °C for 10 seconds at least 1 mm from the plastic.

VHF power amplifier modules

6653931 0030213 23T APX

BGY32 BGY33
BGY35 BGY36

RATINGS

Limiting values in accordance with the Absolute Maximum System (IEC 134)

DC voltages (with respect to flange)

DC supply terminals

V_{B1} and V_{B2} max 15 V

RF input terminal

$\pm V_I$ max 25 V

RF output terminal

$\pm V_O$ max 25 V

Input drive power BGY32 and BGY33

P_D max 200 mW

Input drive power BGY35 and BGY36

P_D max 300 mW

Load power

P_L max 30 W

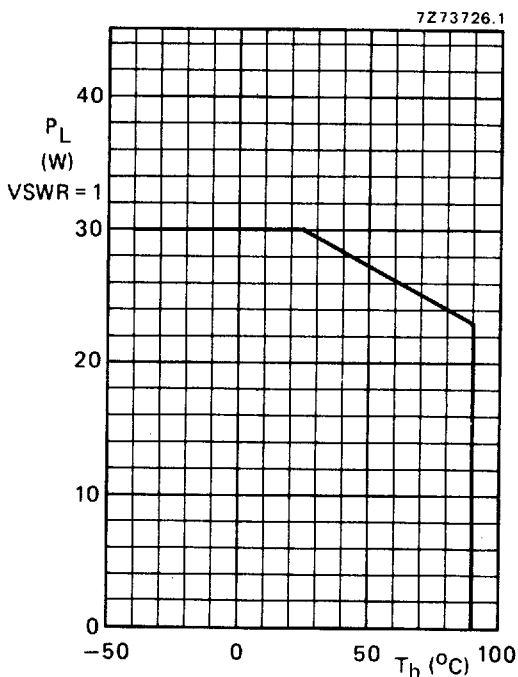

Storage temperature range

T_{stg} -40 to 100 °C

Operating heatsink temperature

T_h max 90 °C

BGY32 BGY33
BGY35 BGY36

6653931 0030214 176 APX

CHARACTERISTICS

$T_h = 25^\circ\text{C}$

Quiescent current

$V_{B1} = V_{B2} = 12,5\text{ V}; P_D = 0;$

$R_S = R_L = 50\ \Omega$

Frequency range

Load power

$V_{B1} = V_{B2} = 12,5\text{ V}; R_S = R_L = 50\ \Omega$

BGY32 and BGY33; $P_D = 100\text{ mW}$

BGY35 and BGY36; $P_D = 150\text{ mW}$

		BGY32	BGY33	BGY35	BGY36
I_{BQ1}	typ	6	6	6	6 mA
I_{BQ2}	typ	13	13	13	13 mA
f	>	68	80	132	148 MHz
	<	88	108	156	174 MHz
P_L	>	18	18	—	— W
	typ	23	22	—	— W
η	>	40	40	—	— %
	typ	50	50	—	— %
P_L	>	—	—	18	18 W
	typ	—	—	22	21 W
η	>	—	—	40	40 %
	typ	—	—	50	50 %

Harmonic output

Any single harmonic will be at least 25 dB down relative to carrier

Input VSWR with respect to 50 Ω

typ 1,5

Stability

The module is stable with a load VSWR up to 3 : 1 (all phases) when operated within the following conditions: $V_{S1} = 6\text{ to }15\text{ V}; V_{S2} = 10\text{ to }15\text{ V}; V_{S1} \leq V_{S2}; P_D = 50\text{ to }200\text{ mW};$ frequency within operating frequency range, provided the maximum ratings of the module are not exceeded.

Ruggedness

The modules are capable of withstanding load mismatch of up to 50 VSWR for short period overload conditions, with P_D, V_{B1} and V_{B2} at maximum values providing the combination does not result in the matched RF output power rating being exceeded.

APPLICATION INFORMATION

Supply

An electrolytic capacitor of 10 μF (25 V), in parallel with a polyester capacitor of 100 nF to earth, is recommended as decoupling arrangement for each power supply pin.

Power rating

In general it is recommended that the output power from the module under nominal design conditions should not exceed 23 W in order to provide adequate safety margin under fault conditions.

Output power control

The module is not designed to be operated over a large range of output power levels. The purpose of the output power control is to set the nominal output power level. The preferred method of output power control is by varying the drive power between 50 and 200 mW. The next option is by varying V_{S1} between 6 and 12.5 V.

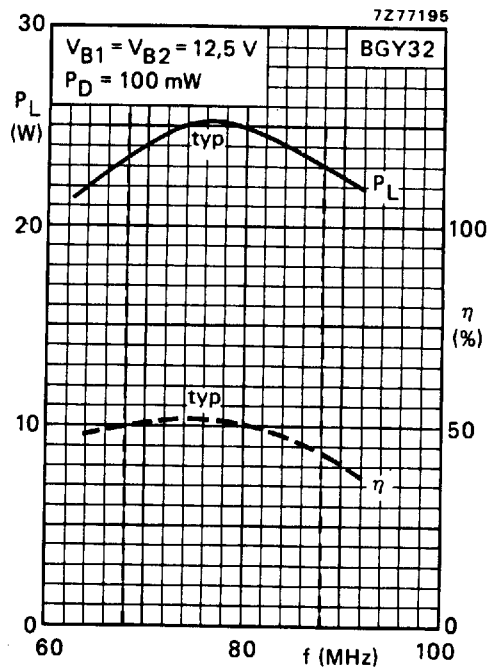
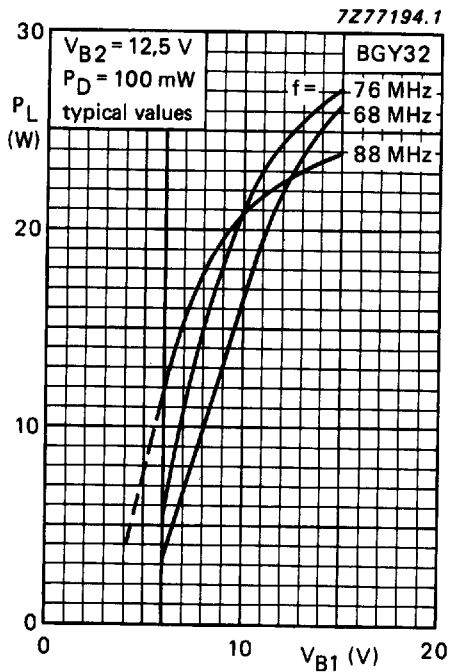
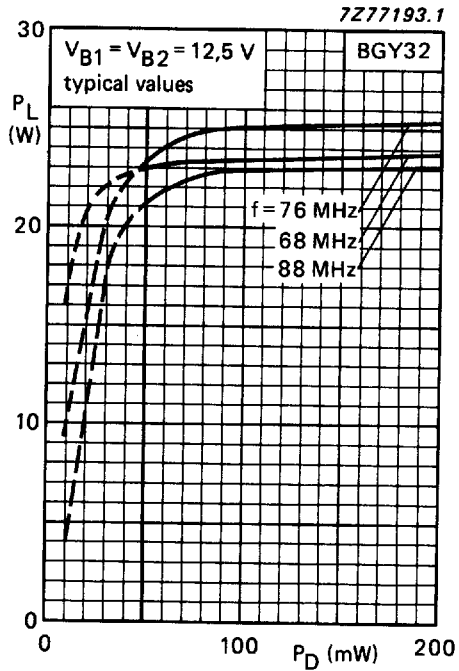
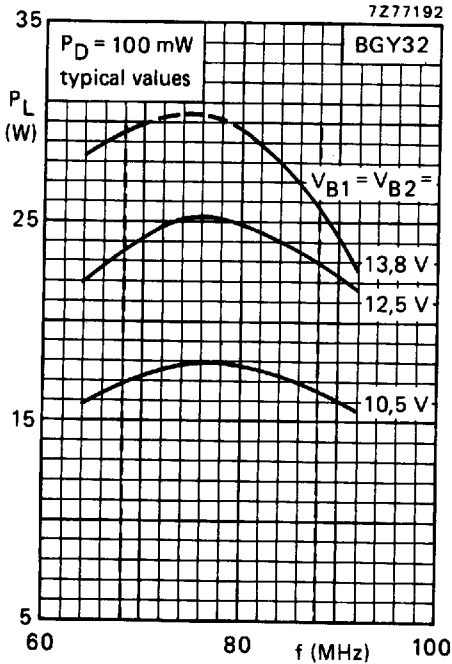

BGY32 BGY33
BGY35 BGY36

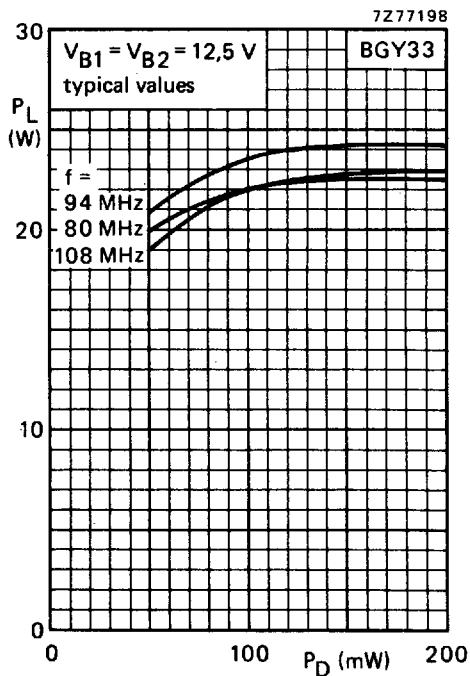
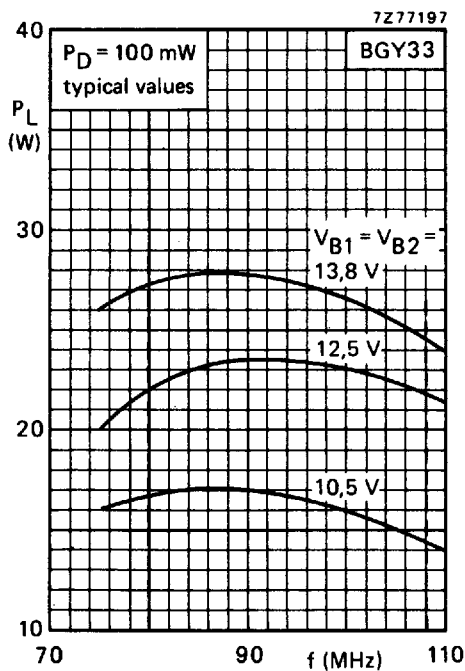
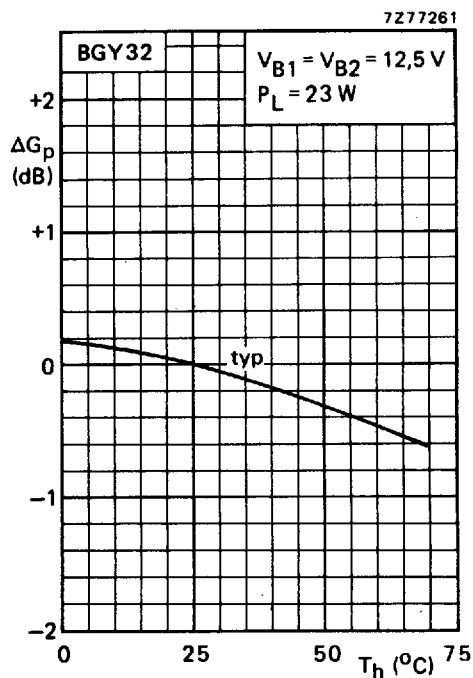
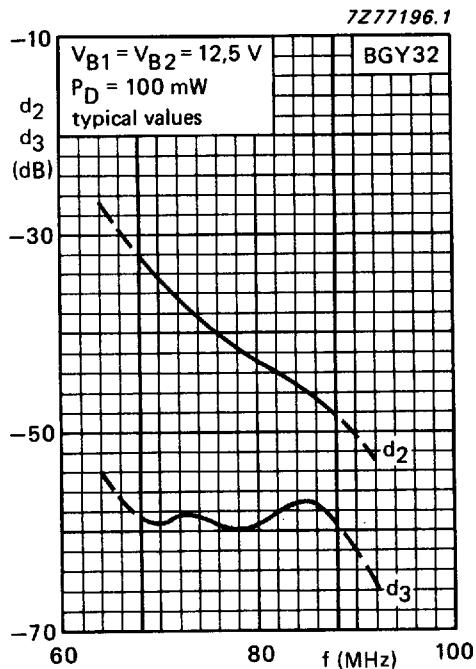

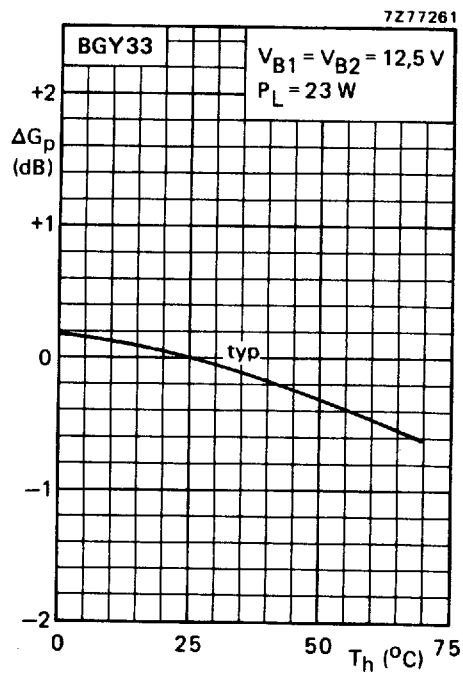
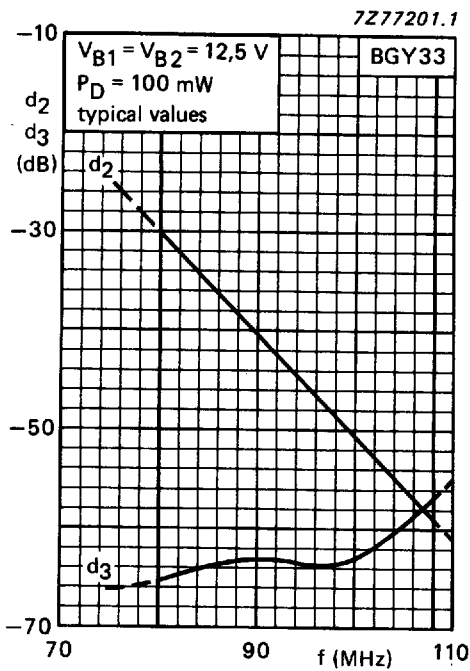
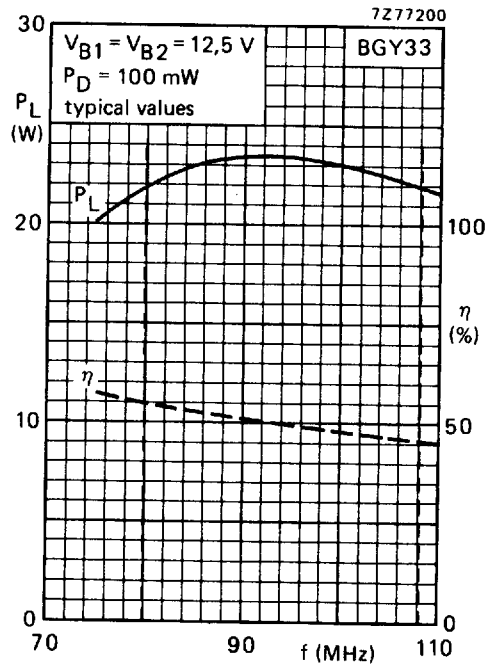
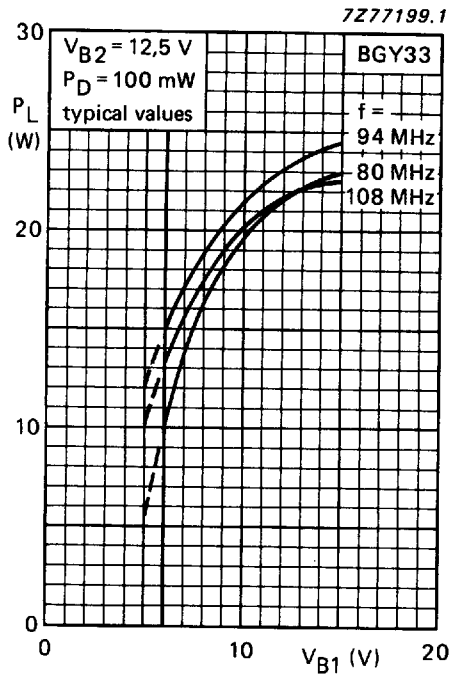

BGY32 BGY33
BGY35 BGY36

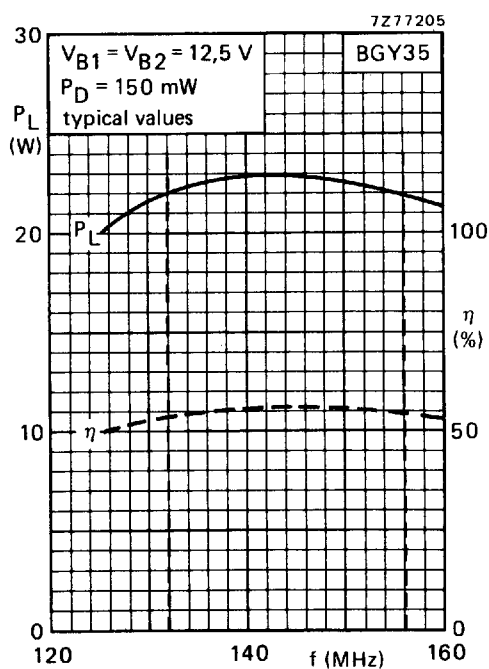
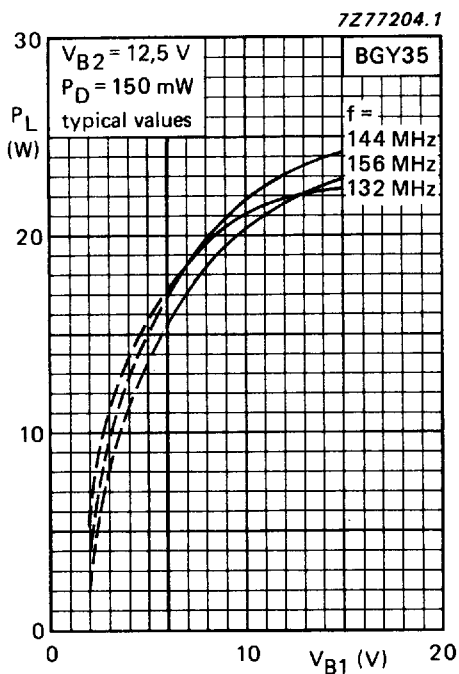
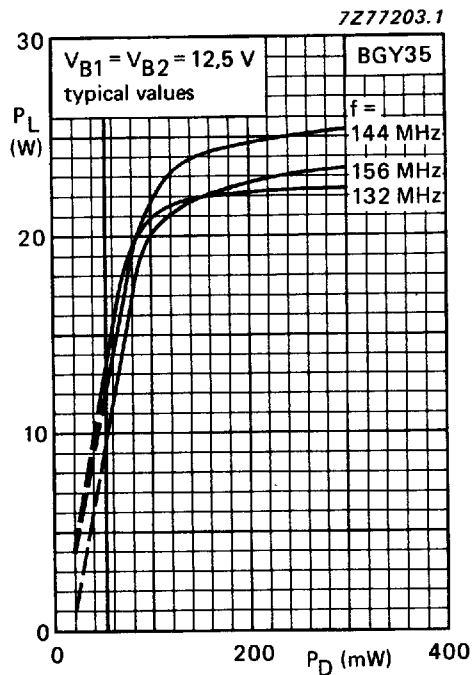
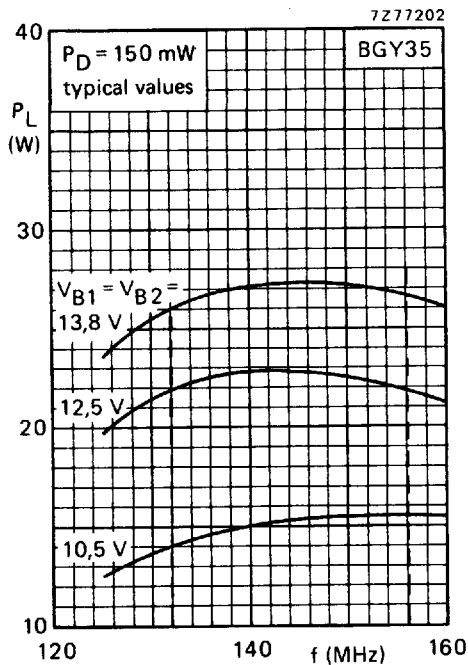

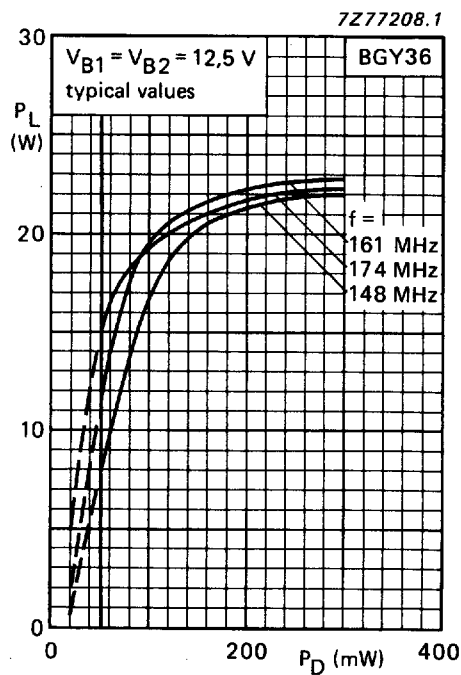
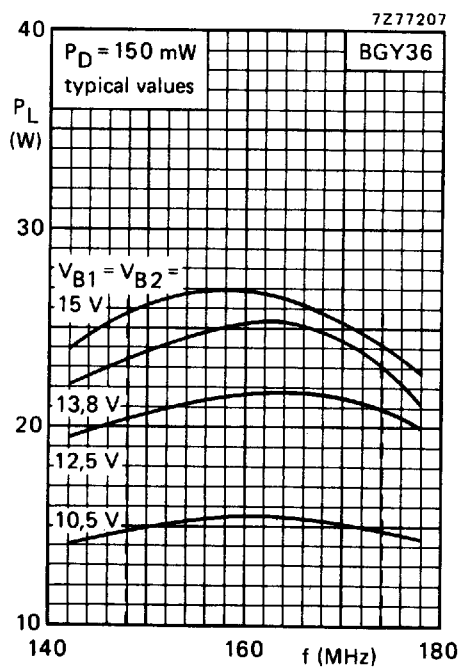
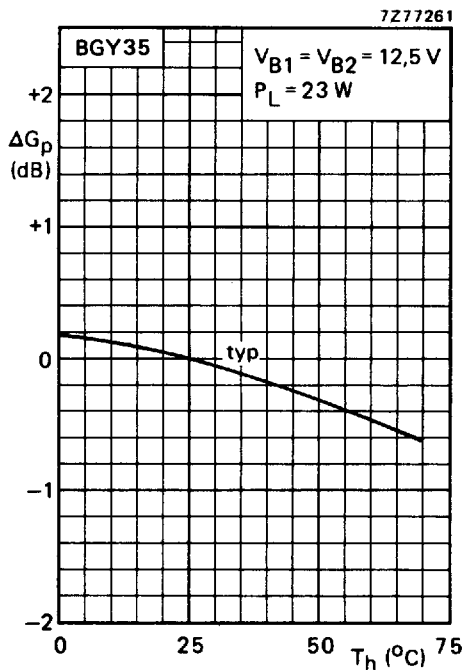
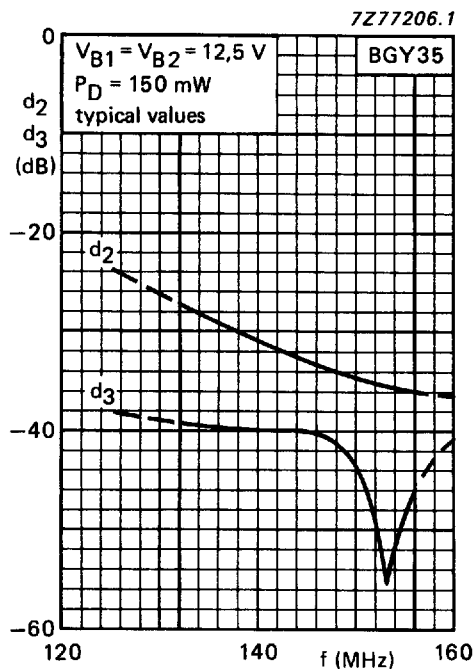

BGY32 BGY33
BGY35 BGY36

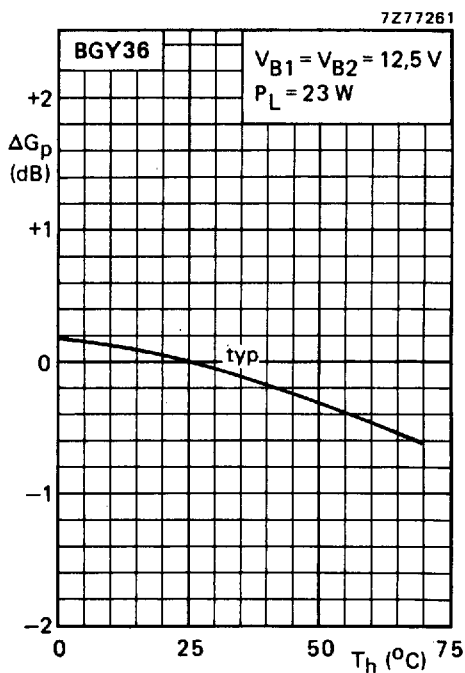
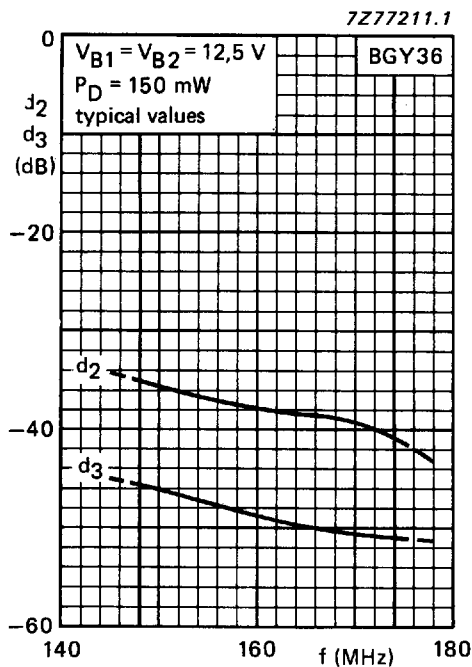
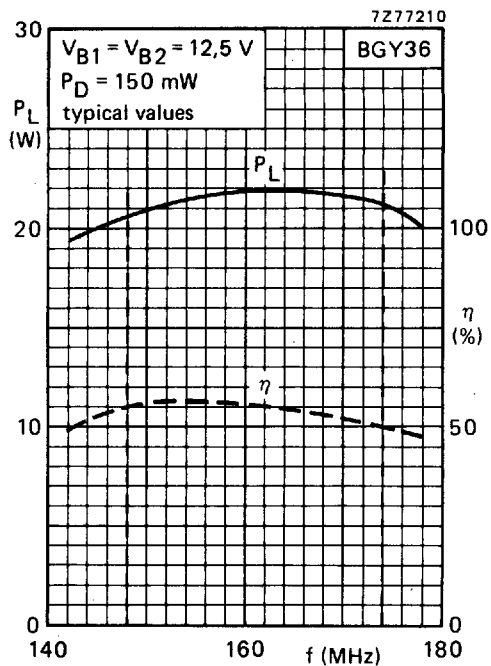
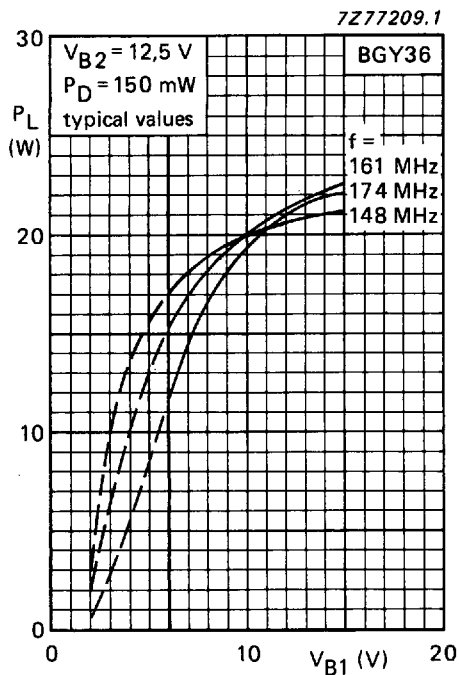



LittleDiode supplies new, hard to find or obsolete electronic components and semiconductors all over the world.

With over two million different components listed you are sure to find the part you need.

Feel free to visit us today at our online store:

LittleDiode.com

Looking forward to providing you with the best possible service.