

N-channel enhancement mode TrenchMOS™ transistor

BSP100

FEATURES

- 'Trench' technology
- Low on-state resistance
- Fast switching
- High thermal cycling performance
- Low thermal resistance

SYMBOL

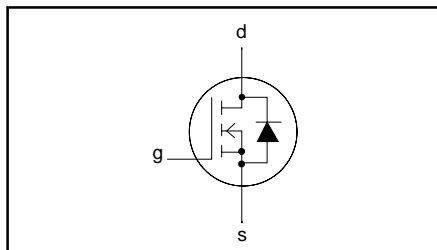

QUICK REFERENCE DATA

$V_{DSS} = 30\text{ V}$
$I_D = 6\text{ A}$
$R_{DS(ON)} \leq 100\text{ m}\Omega$ ($V_{GS} = 10\text{ V}$)
$R_{DS(ON)} \leq 200\text{ m}\Omega$ ($V_{GS} = 4.5\text{ V}$)

GENERAL DESCRIPTION

N-channel enhancement mode field-effect transistor in a plastic envelope using 'trench' technology.

Applications:-

- Motor and relay drivers
- d.c. to d.c. converters
- Logic level translator

The BSP100 is supplied in the SOT223 surface mounting package.

PINNING

PIN	DESCRIPTION
1	gate
2	drain
3	source
4	drain (tab)

SOT223

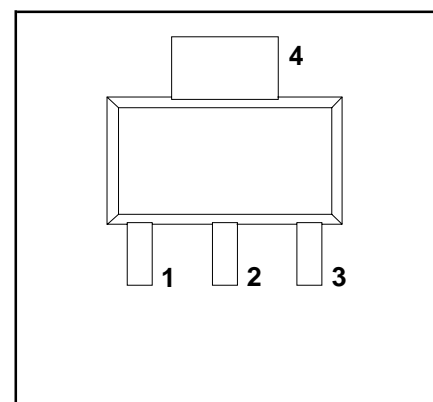

LIMITING VALUES

Limiting values in accordance with the Absolute Maximum System (IEC 134)

SYMBOL	PARAMETER	CONDITIONS	MIN.	MAX.	UNIT
V_{DSS}	Drain-source voltage	$T_j = 25\text{ }^\circ\text{C}$ to $150\text{ }^\circ\text{C}$	-	30	V
V_{DGR}	Drain-gate voltage	$T_j = 25\text{ }^\circ\text{C}$ to $150\text{ }^\circ\text{C}$; $R_{GS} = 20\text{ k}\Omega$	-	30	V
V_{GS}	Gate-source voltage		-	± 20	V
I_D	Continuous drain current	$T_{sp} = 25\text{ }^\circ\text{C}$	-	6 ¹	A
		$T_{sp} = 100\text{ }^\circ\text{C}$	-	4.4	A
		$T_{amb} = 25\text{ }^\circ\text{C}$	-	3.2	A
I_{DM}	Pulsed drain current	$T_{sp} = 25\text{ }^\circ\text{C}$	-	24	A
P_D	Total power dissipation	$T_{sp} = 25\text{ }^\circ\text{C}$	-	8.3	W
T_j, T_{stg}	Operating junction and storage temperature		- 65	150	$^\circ\text{C}$

THERMAL RESISTANCES

SYMBOL	PARAMETER	CONDITIONS	TYP.	MAX.	UNIT
$R_{th\ j-sp}$	Thermal resistance junction to solder point	surface mounted, FR4 board	12	15	K/W
$R_{th\ j-amb}$	Thermal resistance junction to ambient	surface mounted, FR4 board	70	-	K/W

¹ Continuous current rating limited by package

N-channel enhancement mode TrenchMOS™ transistor

BSP100

AVALANCHE ENERGY LIMITING VALUES

Limiting values in accordance with the Absolute Maximum System (IEC 134)

SYMBOL	PARAMETER	CONDITIONS	MIN.	MAX.	UNIT
E_{AS}	Non-repetitive avalanche energy	Unclamped inductive load, $I_{AS} = 6$ A; $t_p = 0.2$ ms; T_j prior to avalanche = 25°C ; $V_{DD} \leq 15$ V; $R_{GS} = 50$ Ω ; $V_{GS} = 10$ V	-	23	mJ
I_{AS}	Non-repetitive avalanche current		-	6	A

ELECTRICAL CHARACTERISTICS

 $T_j = 25^\circ\text{C}$ unless otherwise specified

SYMBOL	PARAMETER	CONDITIONS	MIN.	TYP.	MAX.	UNIT
$V_{(BR)DSS}$	Drain-source breakdown voltage	$V_{GS} = 0$ V; $I_D = 10$ μA ; $T_j = -55^\circ\text{C}$	30 27	- -	- -	V V
$V_{GS(TO)}$	Gate threshold voltage	$V_{DS} = V_{GS}$; $I_D = 1$ mA $T_j = 150^\circ\text{C}$ $T_j = -55^\circ\text{C}$	1 0.4 -	2 -	2.8 - 3.2	V V V
$R_{DS(ON)}$	Drain-source on-state resistance	$V_{GS} = 10$ V; $I_D = 2.2$ A $V_{GS} = 4.5$ V; $I_D = 1$ A $V_{GS} = 10$ V; $I_D = 2.2$ A; $T_j = 150^\circ\text{C}$	- - -	80 120 -	100 200 170	m Ω m Ω m Ω
g_{fs}	Forward transconductance	$V_{DS} = 20$ V; $I_D = 2.2$ A	2	4.5	-	S
$I_{D(ON)}$	On-state drain current	$V_{GS} = 10$ V; $V_{DS} = 1$ V; $V_{GS} = 4.5$ V; $V_{DS} = 5$ V	3.5 2	- -	- -	A A
I_{DSS}	Zero gate voltage drain current	$V_{DS} = 24$ V; $V_{GS} = 0$ V; $V_{DS} = 24$ V; $V_{GS} = 0$ V; $T_j = 150^\circ\text{C}$	- -	10 0.6	100 10	nA μA
I_{GSS}	Gate source leakage current	$V_{GS} = \pm 20$ V; $V_{DS} = 0$ V	-	10	100	nA
$Q_{g(tot)}$	Total gate charge	$I_D = 2.3$ A; $V_{DD} = 15$ V; $V_{GS} = 10$ V	-	6	-	nC
Q_{gs}	Gate-source charge		-	0.7	-	nC
Q_{gd}	Gate-drain (Miller) charge		-	0.7	-	nC
$t_{d on}$	Turn-on delay time	$V_{DD} = 20$ V; $R_D = 18$ Ω ; $V_{GS} = 10$ V; $R_G = 6$ Ω Resistive load	-	6	-	ns
t_r	Turn-on rise time		-	8	-	ns
$t_{d off}$	Turn-off delay time		-	21	-	ns
t_f	Turn-off fall time		-	15	-	ns
L_d	Internal drain inductance	Measured tab to centre of die	-	2.5	-	nH
L_s	Internal source inductance	Measured from source lead to source bond pad	-	5	-	nH
C_{iss}	Input capacitance	$V_{GS} = 0$ V; $V_{DS} = 20$ V; $f = 1$ MHz	-	250	-	pF
C_{oss}	Output capacitance		-	88	-	pF
C_{rss}	Feedback capacitance		-	54	-	pF

N-channel enhancement mode
TrenchMOS™ transistor

BSP100

REVERSE DIODE LIMITING VALUES AND CHARACTERISTICS

T_j = 25 °C unless otherwise specified

SYMBOL	PARAMETER	CONDITIONS	MIN.	TYP.	MAX.	UNIT
I _S	Continuous source current (body diode)	T _{sp} = 25 °C	-	-	6	A
I _{SM}	Pulsed source current (body diode)		-	-	24	A
V _{SD}	Diode forward voltage	I _F = 1.25 A; V _{GS} = 0 V	-	0.82	1.2	V
t _{rr}	Reverse recovery time	I _F = 1.25 A; -di _F /dt = 100 A/μs;	-	69	-	ns
Q _{rr}	Reverse recovery charge	V _{GS} = 0 V; V _R = 25 V	-	55	-	nC

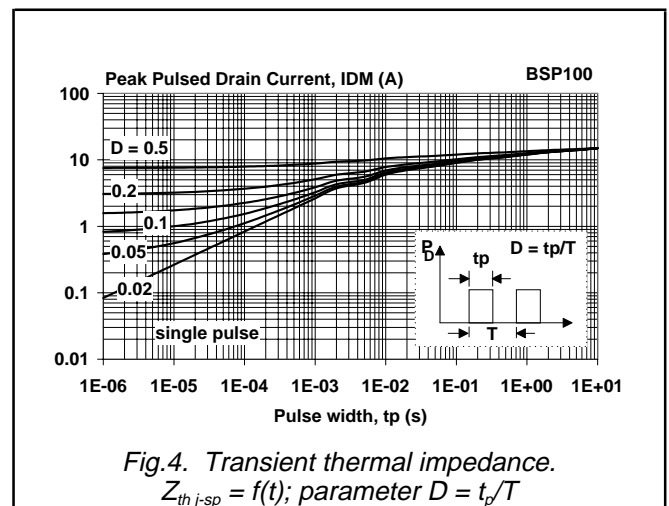
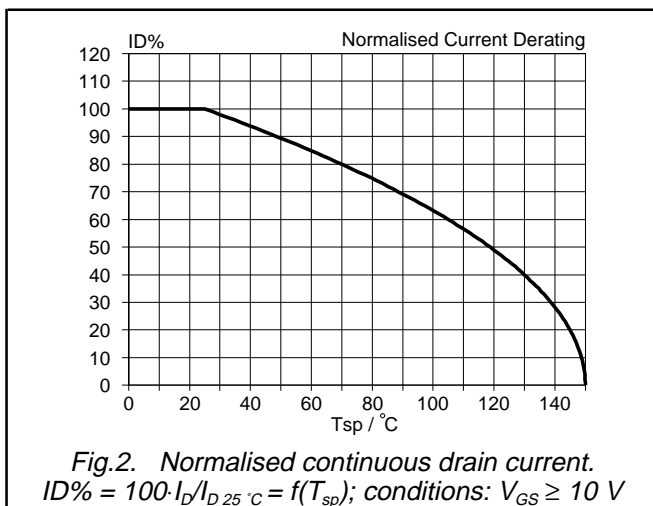
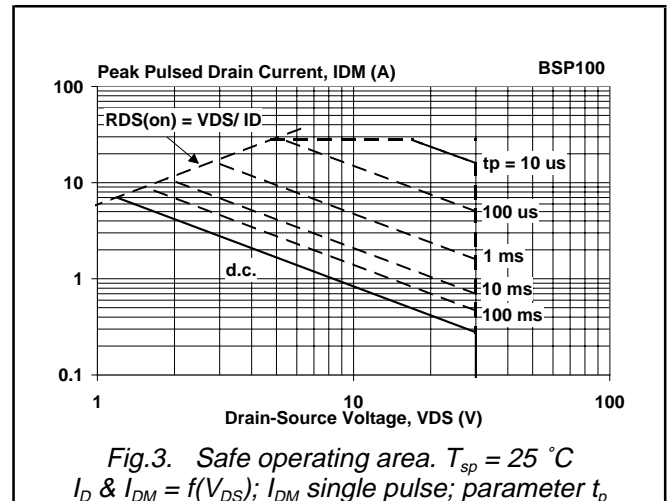
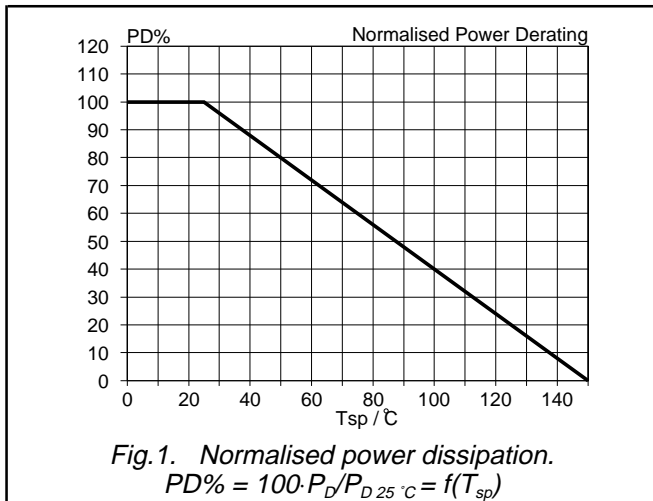

N-channel enhancement mode
TrenchMOS™ transistor

BSP100

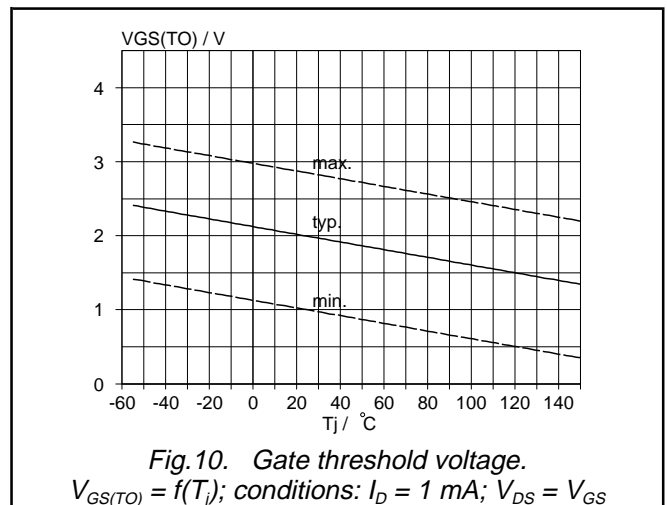
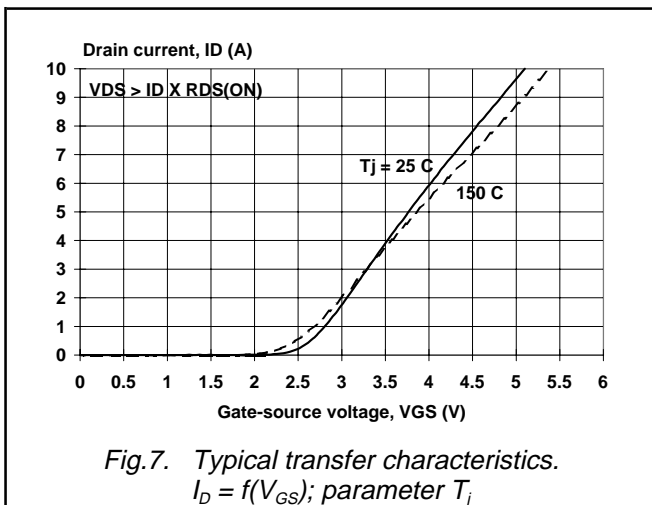
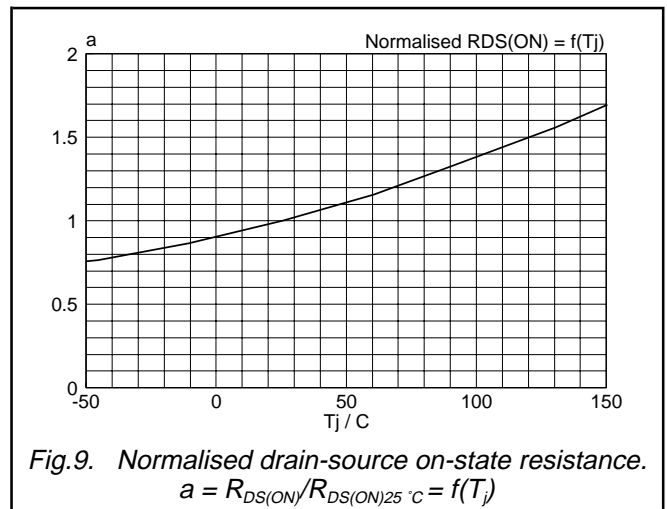
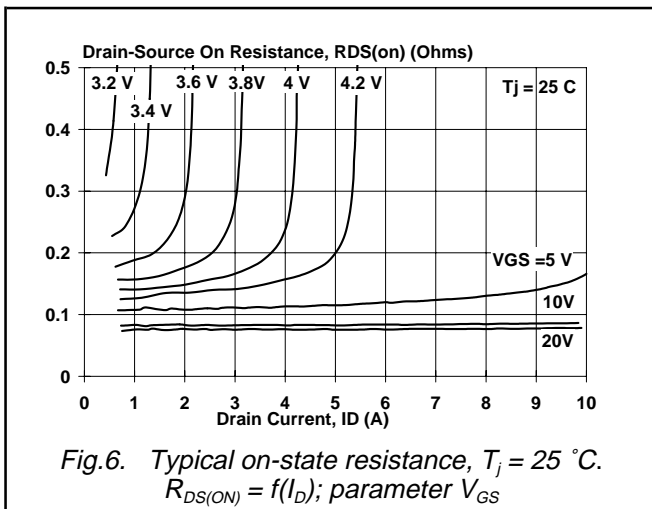
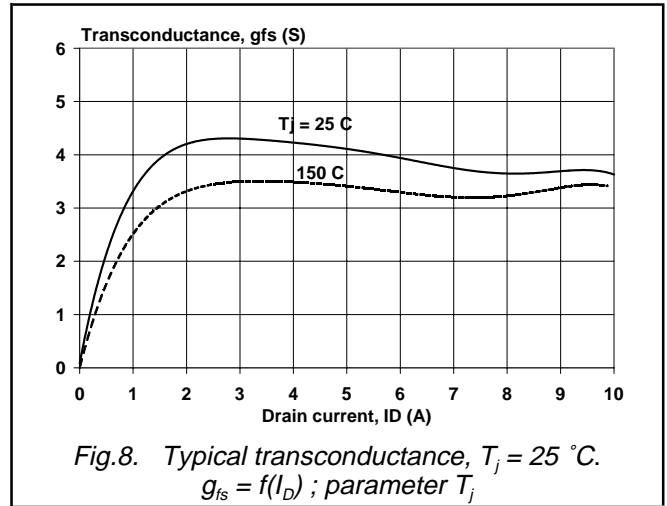
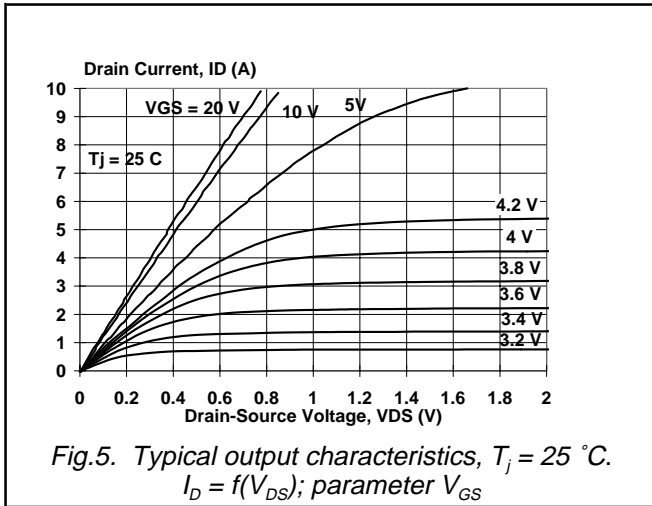

N-channel enhancement mode
TrenchMOS™ transistor

BSP100

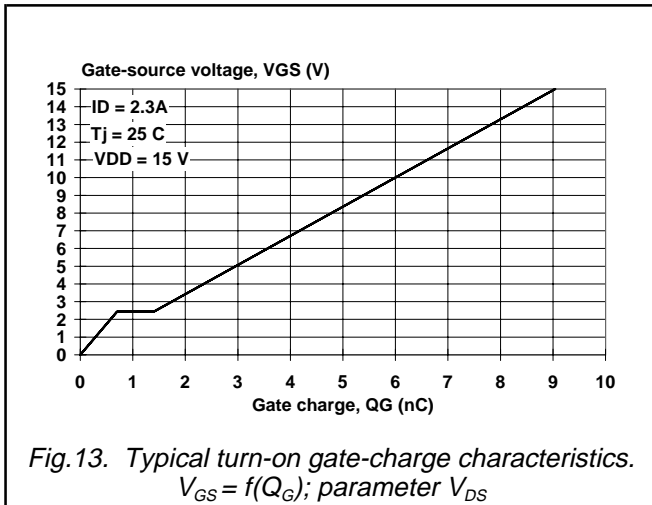
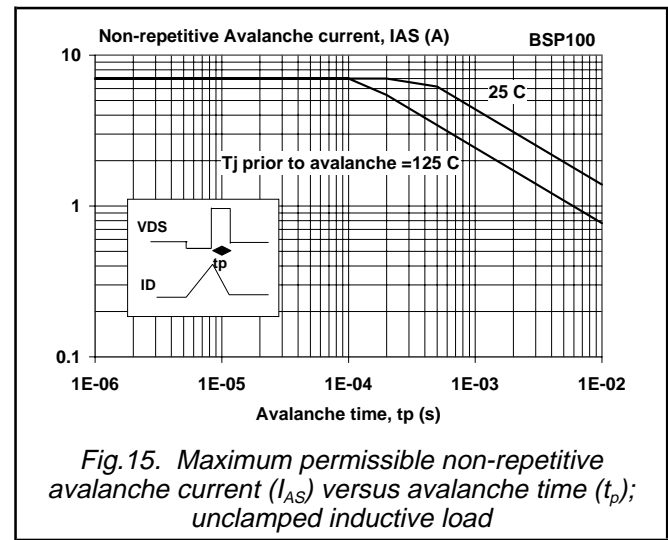
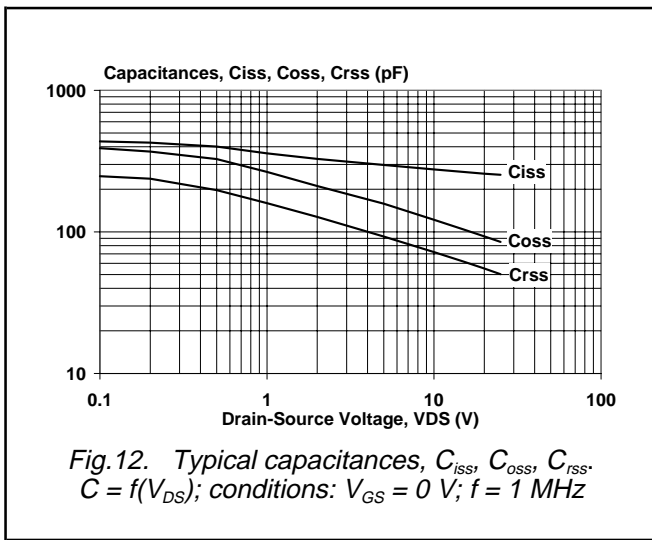
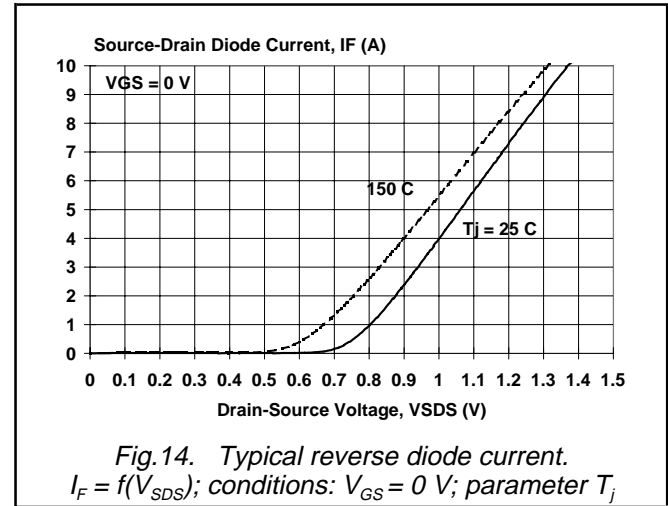
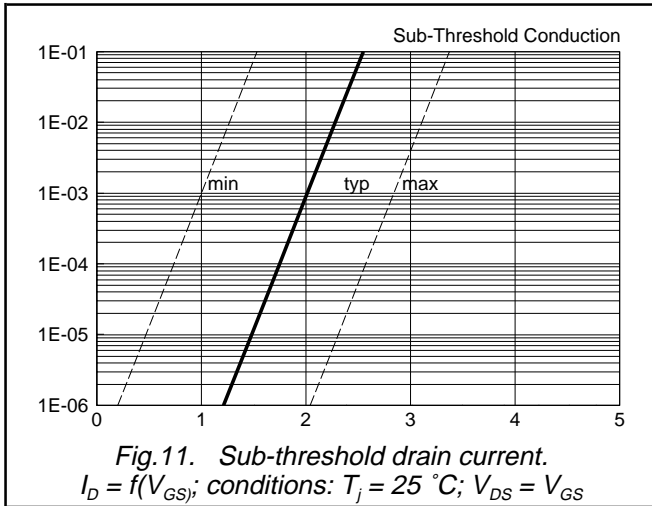

N-channel enhancement mode
TrenchMOS™ transistor

BSP100

PRINTED CIRCUIT BOARD

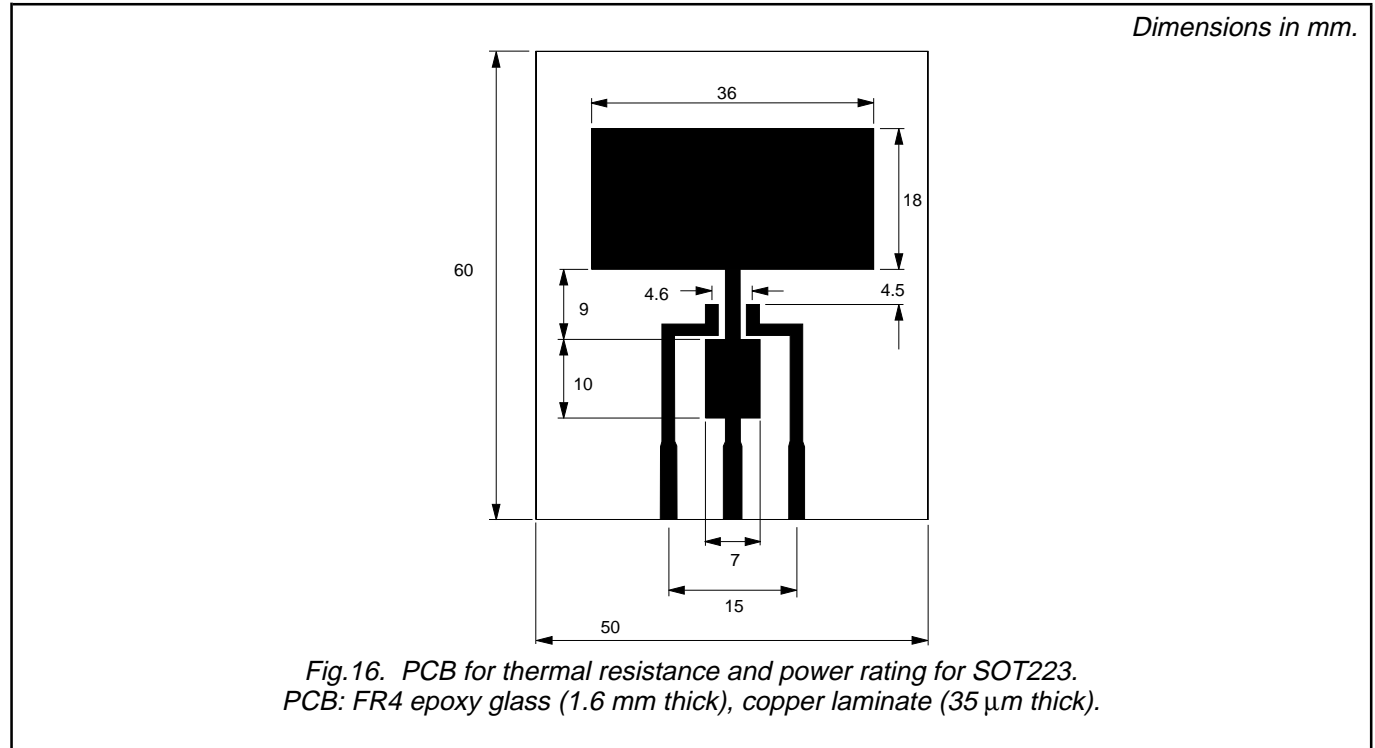

N-channel enhancement mode
TrenchMOS™ transistor

BSP100

MECHANICAL DATA

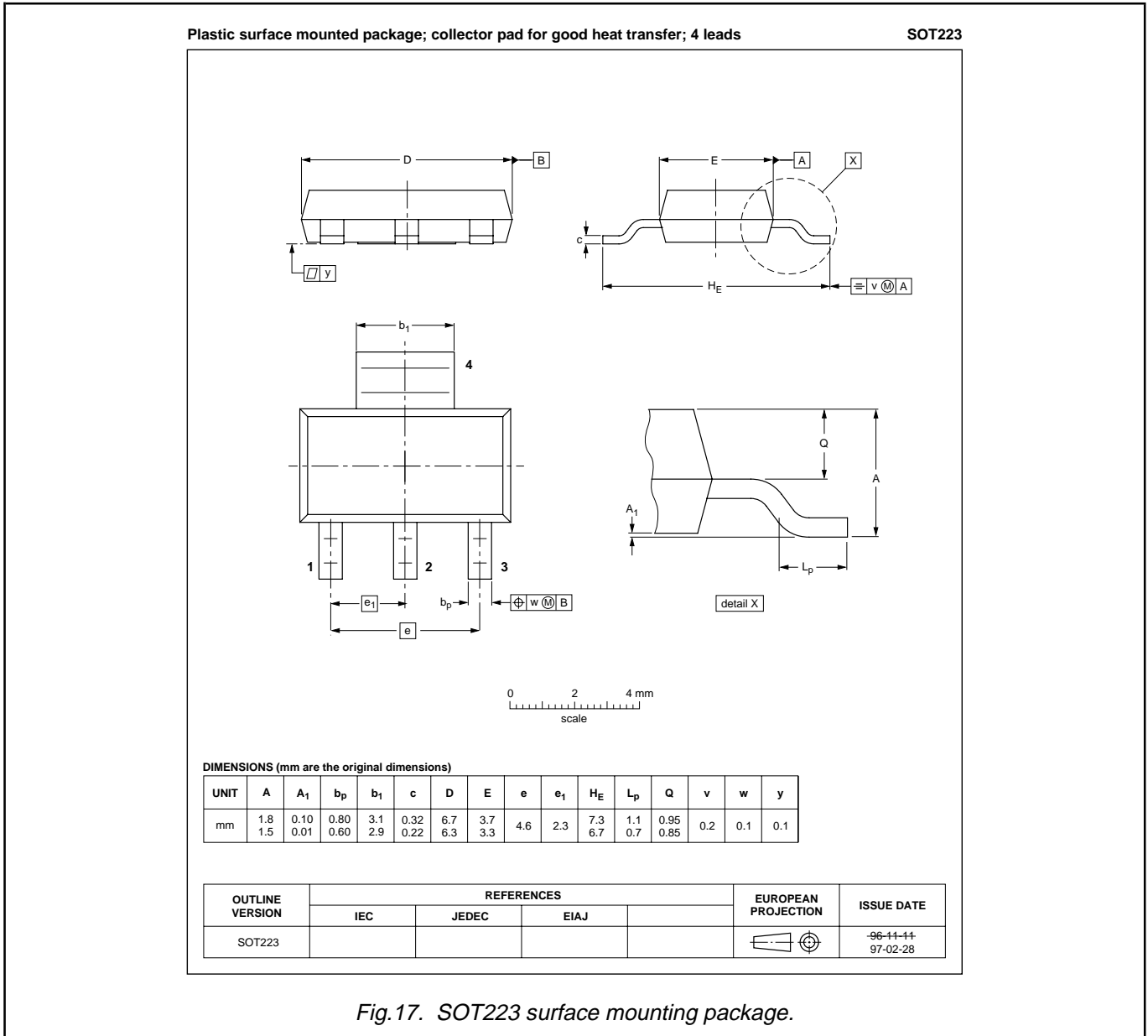

Fig.17. SOT223 surface mounting package.

Notes

1. This product is supplied in anti-static packaging. The gate-source input must be protected against static discharge during transport or handling.
2. Refer to Discrete Semiconductor Packages, Data Handbook SC18.
3. Epoxy meets UL94 V0 at 1/8".

N-channel enhancement mode TrenchMOS™ transistor

BSP100

DEFINITIONS

Data sheet status	
Objective specification	This data sheet contains target or goal specifications for product development.
Preliminary specification	This data sheet contains preliminary data; supplementary data may be published later.
Product specification	This data sheet contains final product specifications.
Limiting values	
Limiting values are given in accordance with the Absolute Maximum Rating System (IEC 134). Stress above one or more of the limiting values may cause permanent damage to the device. These are stress ratings only and operation of the device at these or at any other conditions above those given in the Characteristics sections of this specification is not implied. Exposure to limiting values for extended periods may affect device reliability.	
Application information	
Where application information is given, it is advisory and does not form part of the specification.	
© Philips Electronics N.V. 1999	
All rights are reserved. Reproduction in whole or in part is prohibited without the prior written consent of the copyright owner.	
The information presented in this document does not form part of any quotation or contract, it is believed to be accurate and reliable and may be changed without notice. No liability will be accepted by the publisher for any consequence of its use. Publication thereof does not convey nor imply any license under patent or other industrial or intellectual property rights.	

LIFE SUPPORT APPLICATIONS

These products are not designed for use in life support appliances, devices or systems where malfunction of these products can be reasonably expected to result in personal injury. Philips customers using or selling these products for use in such applications do so at their own risk and agree to fully indemnify Philips for any damages resulting from such improper use or sale.



LittleDiode supplies new, hard to find or obsolete electronic components and semiconductors all over the world.

With over two million different components listed you are sure to find the part you need.

Feel free to visit us today at our online store:

LittleDiode.com

Looking forward to providing you with the best possible service.