

**PowerMOS transistor
Logic level FET**

BUK545-100A/B

GENERAL DESCRIPTION

N-channel enhancement mode logic level field-effect power transistor in a plastic full-pack envelope.
The device is intended for use in Switched Mode Power Supplies (SMPS), motor control, welding, DC/DC and AC/DC converters, and in automotive and general purpose switching applications.

QUICK REFERENCE DATA

| SYMBOL | PARAMETER | MAX. | MAX. | UNIT |
|--------------|---|--------------|--------------|----------|
| | BUK545 | -100A | -100B | |
| V_{DS} | Drain-source voltage | 100 | 100 | V |
| I_D | Drain current (DC) | 13 | 12 | A |
| P_{tot} | Total power dissipation | 30 | 30 | W |
| T_j | Junction temperature | 150 | 150 | °C |
| $R_{DS(ON)}$ | Drain-source on-state resistance; $V_{GS} = 5\text{ V}$ | 0.085 | 0.11 | Ω |

PINNING - SOT186

| PIN | DESCRIPTION |
|------|-------------|
| 1 | gate |
| 2 | drain |
| 3 | source |
| case | isolated |

PIN CONFIGURATION

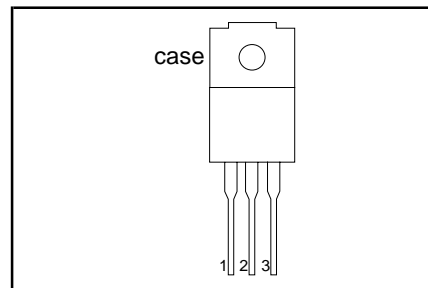

SYMBOL

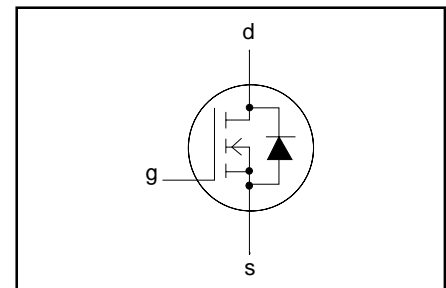

LIMITING VALUES

Limiting values in accordance with the Absolute Maximum System (IEC 134)

| SYMBOL | PARAMETER | CONDITIONS | MIN. | MAX. | UNIT |
|---------------|------------------------------------|------------------------------|------|--------------------|------|
| V_{DS} | Drain-source voltage | - | - | 100 | V |
| V_{DGR} | Drain-gate voltage | $R_{GS} = 20\text{ k}\Omega$ | - | 100 | V |
| $\pm V_{GS}$ | Gate-source voltage | - | - | 15 | V |
| $\pm V_{GSM}$ | Non-repetitive gate-source voltage | $t_p \leq 50\ \mu\text{s}$ | - | 20 | V |
| I_D | Drain current (DC) | $T_{hs} = 25\text{ °C}$ | - | -100A 13 | A |
| I_D | Drain current (DC) | $T_{hs} = 100\text{ °C}$ | - | 8.2 | A |
| I_{DM} | Drain current (pulse peak value) | $T_{hs} = 25\text{ °C}$ | - | 52 | A |
| P_{tot} | Total power dissipation | $T_{hs} = 25\text{ °C}$ | - | 30 | W |
| T_{stg} | Storage temperature | - | -55 | 150 | °C |
| T_j | Junction Temperature | - | - | 150 | °C |

THERMAL RESISTANCES

| SYMBOL | PARAMETER | CONDITIONS | MIN. | TYP. | MAX. | UNIT |
|----------------|---|------------------------|------|------|------|------|
| $R_{th\ j-hs}$ | Thermal resistance junction to heatsink | with heatsink compound | - | - | 4.17 | K/W |
| $R_{th\ j-a}$ | Thermal resistance junction to ambient | | - | 55 | - | K/W |

PowerMOS transistor

Logic level FET

BUK545-100A/B

STATIC CHARACTERISTICS

 $T_{hs} = 25\text{ }^{\circ}\text{C}$ unless otherwise specified

| SYMBOL | PARAMETER | CONDITIONS | MIN. | TYP. | MAX. | UNIT |
|---------------|----------------------------------|---|------|-------|-------|---------------|
| $V_{(BR)DSS}$ | Drain-source breakdown voltage | $V_{GS} = 0\text{ V}; I_D = 0.25\text{ mA}$ | 100 | - | - | V |
| $V_{GS(TO)}$ | Gate threshold voltage | $V_{DS} = V_{GS}; I_D = 1\text{ mA}$ | 1.0 | 1.5 | 2.0 | V |
| I_{DSS} | Zero gate voltage drain current | $V_{DS} = 100\text{ V}; V_{GS} = 0\text{ V}; T_j = 25\text{ }^{\circ}\text{C}$ | - | 1 | 10 | μA |
| I_{DSS} | Zero gate voltage drain current | $V_{DS} = 100\text{ V}; V_{GS} = 0\text{ V}; T_j = 125\text{ }^{\circ}\text{C}$ | - | 0.1 | 1.0 | mA |
| I_{GSS} | Gate source leakage current | $V_{GS} = \pm 10\text{ V}; V_{DS} = 0\text{ V}$ | - | 10 | 100 | nA |
| $R_{DS(ON)}$ | Drain-source on-state resistance | $V_{GS} = 5\text{ V}; I_D = 13\text{ A}$ | - | 0.075 | 0.085 | Ω |
| | | BUK545-100A | - | 0.09 | 0.11 | Ω |
| | | BUK545-100B | - | | | |

DYNAMIC CHARACTERISTICS

 $T_{hs} = 25\text{ }^{\circ}\text{C}$ unless otherwise specified

| SYMBOL | PARAMETER | CONDITIONS | MIN. | TYP. | MAX. | UNIT |
|------------|----------------------------|--|------|------|------|------|
| g_{fs} | Forward transconductance | $V_{DS} = 25\text{ V}; I_D = 13\text{ A}$ | 10 | 13.5 | - | S |
| C_{iss} | Input capacitance | $V_{GS} = 0\text{ V}; V_{DS} = 25\text{ V}; f = 1\text{ MHz}$ | - | 1450 | 1750 | pF |
| C_{oss} | Output capacitance | | - | 280 | 350 | pF |
| C_{rss} | Feedback capacitance | | - | 100 | 150 | pF |
| t_{don} | Turn-on delay time | $V_{DD} = 30\text{ V}; I_D = 3\text{ A};$ | - | 25 | 40 | ns |
| t_r | Turn-on rise time | $V_{GS} = 5\text{ V}; R_{GS} = 50\text{ }\Omega;$ | - | 65 | 85 | ns |
| t_{doff} | Turn-off delay time | $R_{gen} = 50\text{ }\Omega$ | - | 135 | 180 | ns |
| t_f | Turn-off fall time | | - | 80 | 110 | ns |
| L_d | Internal drain inductance | Measured from drain lead 6 mm from package to centre of die | - | 4.5 | - | nH |
| L_s | Internal source inductance | Measured from source lead 6 mm from package to source bond pad | - | 7.5 | - | nH |

ISOLATION LIMITING VALUE & CHARACTERISTIC

 $T_{hs} = 25\text{ }^{\circ}\text{C}$ unless otherwise specified

| SYMBOL | PARAMETER | CONDITIONS | MIN. | TYP. | MAX. | UNIT |
|------------|---|---------------------------------------|------|------|------|------|
| V_{isol} | Repetitive peak voltage from all three terminals to external heatsink | R.H. $\leq 65\%$; clean and dustfree | - | | 1500 | V |
| C_{isol} | Capacitance from T2 to external heatsink | $f = 1\text{ MHz}$ | - | 12 | - | pF |

REVERSE DIODE LIMITING VALUES AND CHARACTERISTICS

 $T_{hs} = 25\text{ }^{\circ}\text{C}$ unless otherwise specified

| SYMBOL | PARAMETER | CONDITIONS | MIN. | TYP. | MAX. | UNIT |
|-----------|----------------------------------|---|------|------|------|---------------|
| I_{DR} | Continuous reverse drain current | - | - | - | 13 | A |
| I_{DRM} | Pulsed reverse drain current | - | - | - | 52 | A |
| V_{SD} | Diode forward voltage | $I_F = 13\text{ A}; V_{GS} = 0\text{ V}$ | - | 1.3 | 1.7 | V |
| t_{rr} | Reverse recovery time | $I_F = 13\text{ A}; -di_F/dt = 100\text{ A}/\mu\text{s};$ | - | 90 | - | ns |
| Q_{rr} | Reverse recovery charge | $V_{GS} = 0\text{ V}; V_R = 30\text{ V}$ | - | 0.70 | - | μC |

PowerMOS transistor
Logic level FET

BUK545-100A/B

AVALANCHE LIMITING VALUE

$T_{hs} = 25\text{ }^\circ\text{C}$ unless otherwise specified

| SYMBOL | PARAMETER | CONDITIONS | MIN. | TYP. | MAX. | UNIT |
|-----------|---|--|------|------|------|------|
| W_{DSS} | Drain-source non-repetitive unclamped inductive turn-off energy | $I_D = 25\text{ A}$; $V_{DD} \leq 50\text{ V}$; $V_{GS} = 5\text{ V}$; $R_{GS} = 50\ \Omega$ | - | - | 140 | mJ |

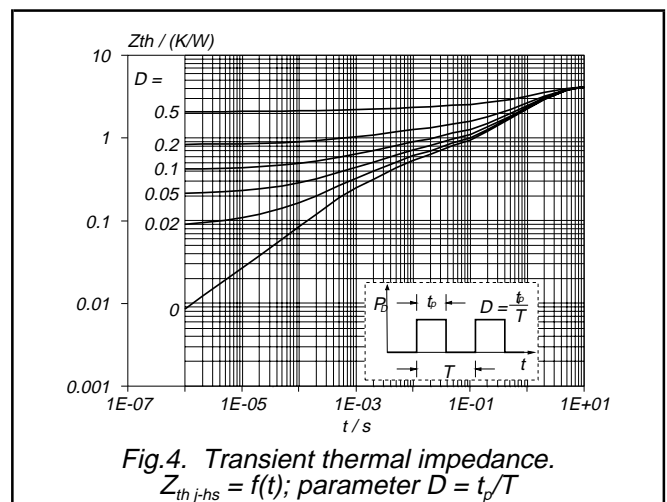
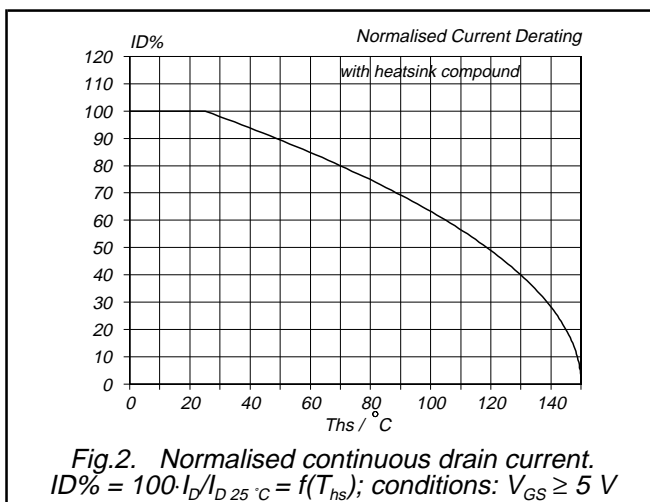
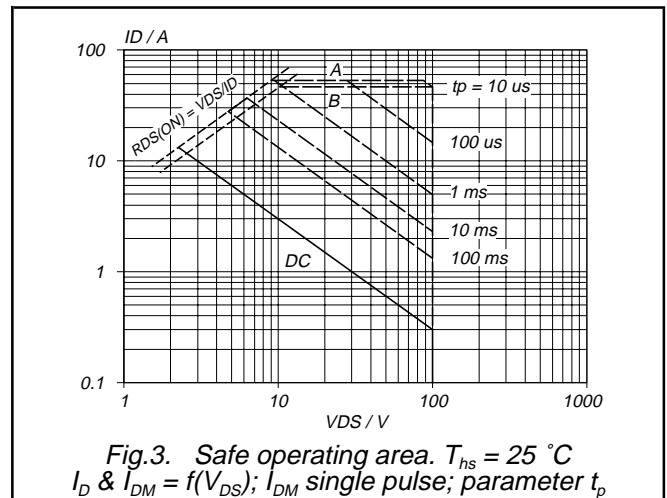
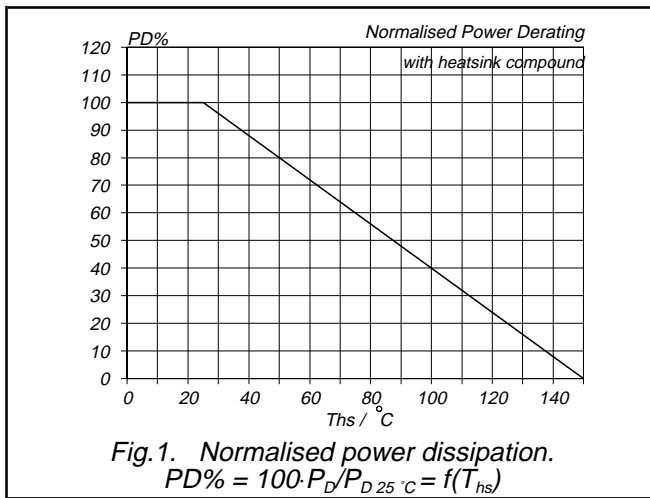

PowerMOS transistor
Logic level FET

BUK545-100A/B

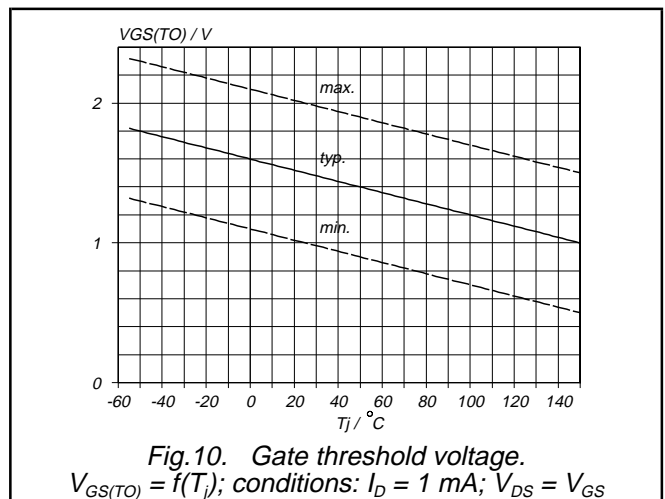
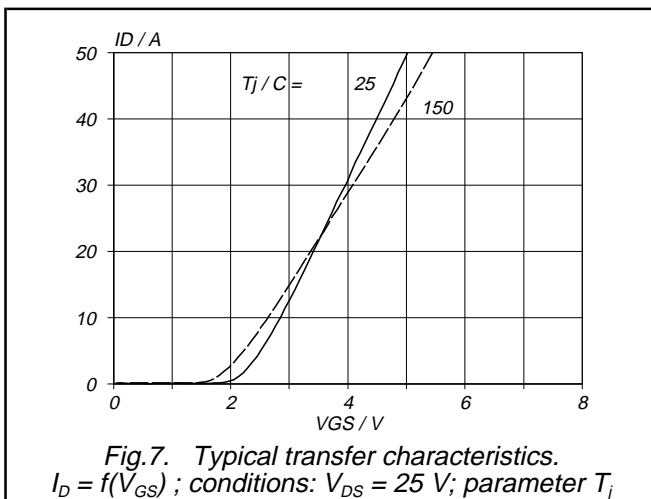
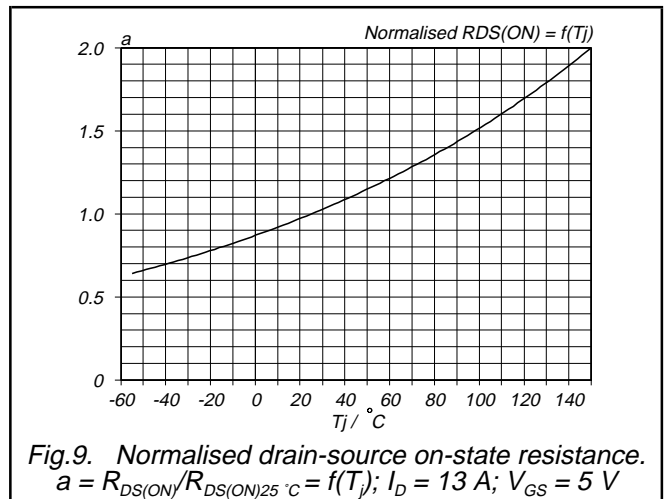
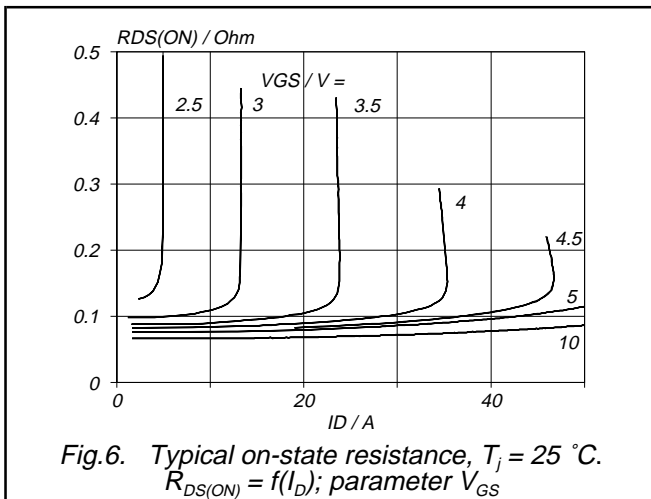
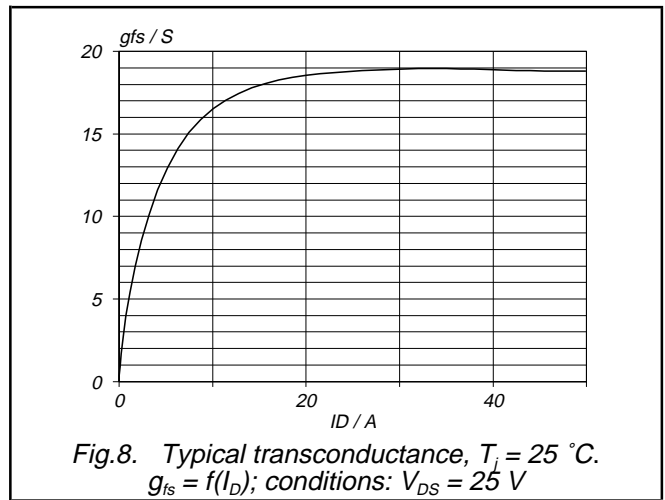
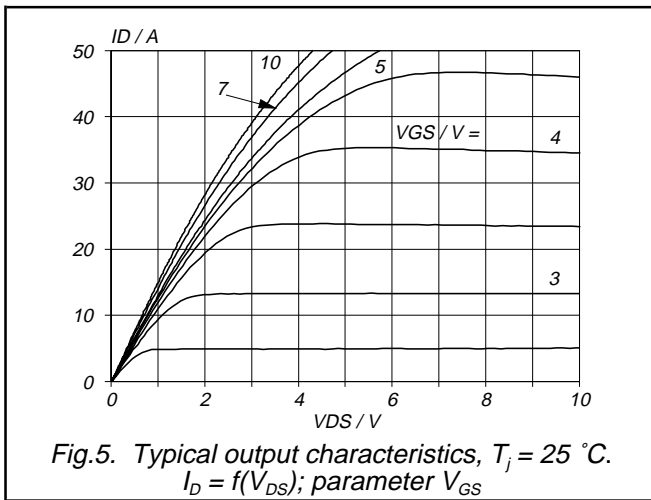

PowerMOS transistor
Logic level FET

BUK545-100A/B

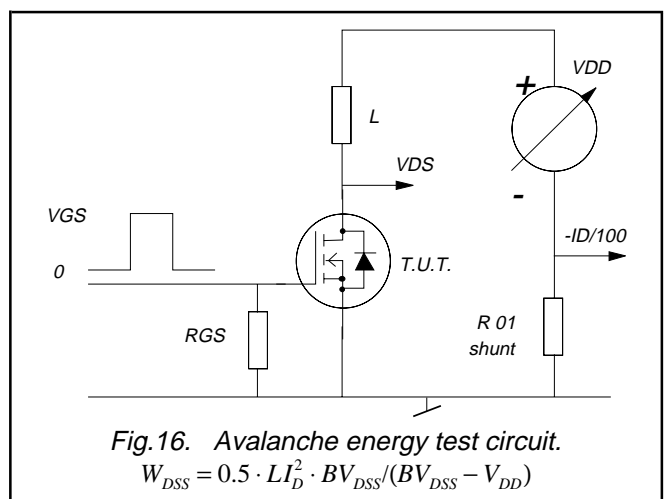
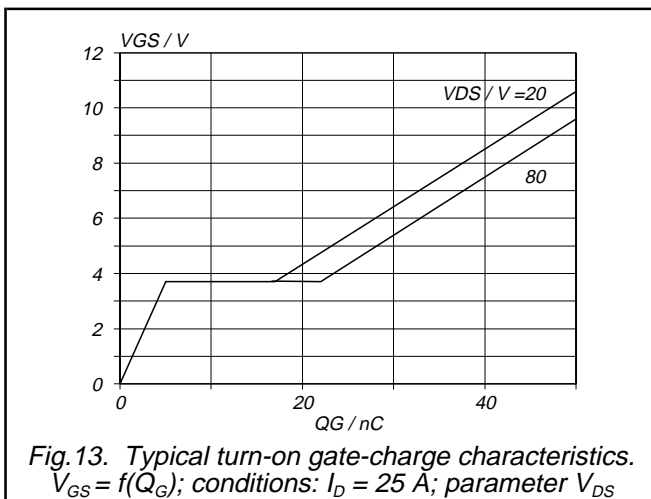
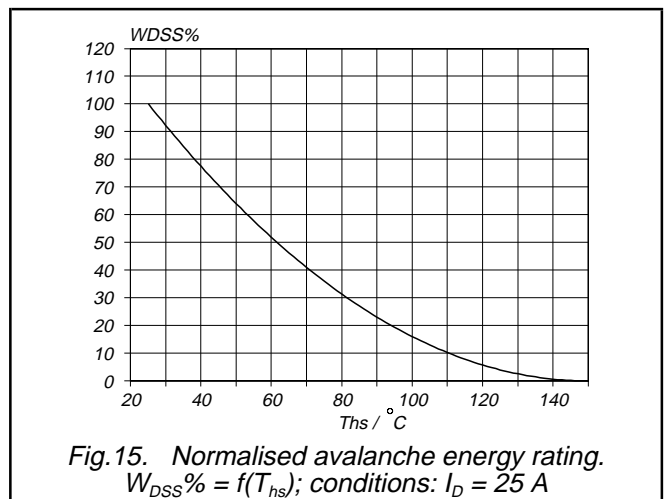
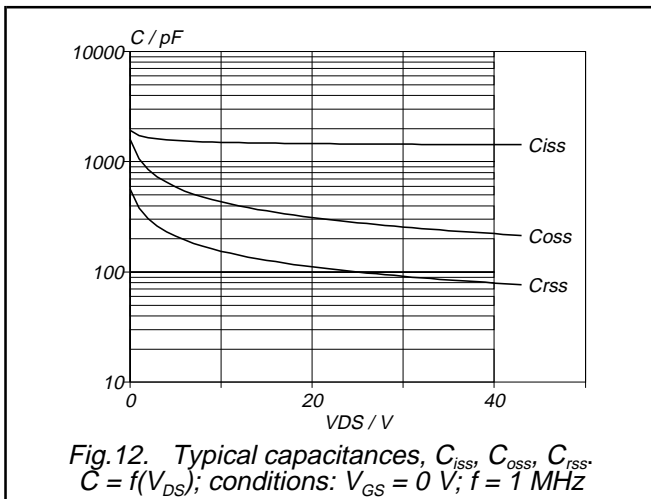
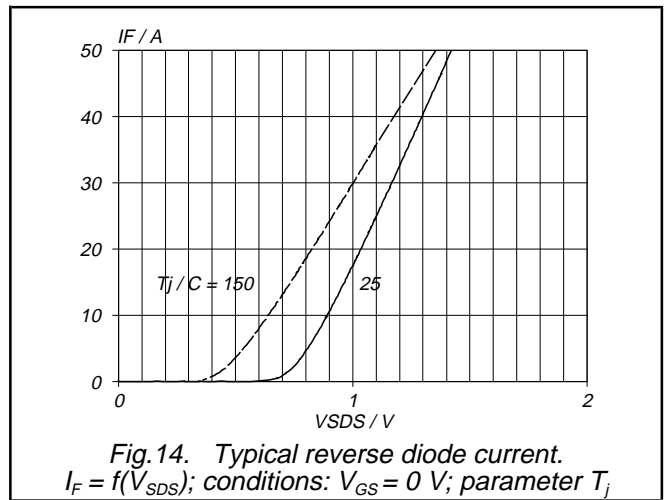
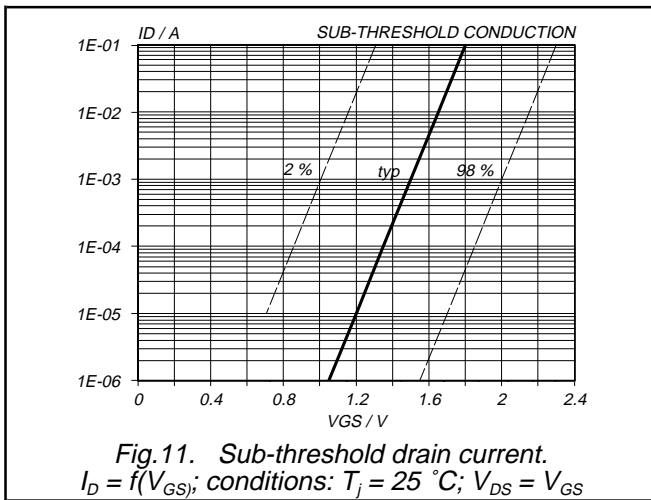

PowerMOS transistor
Logic level FET

BUK545-100A/B

MECHANICAL DATA

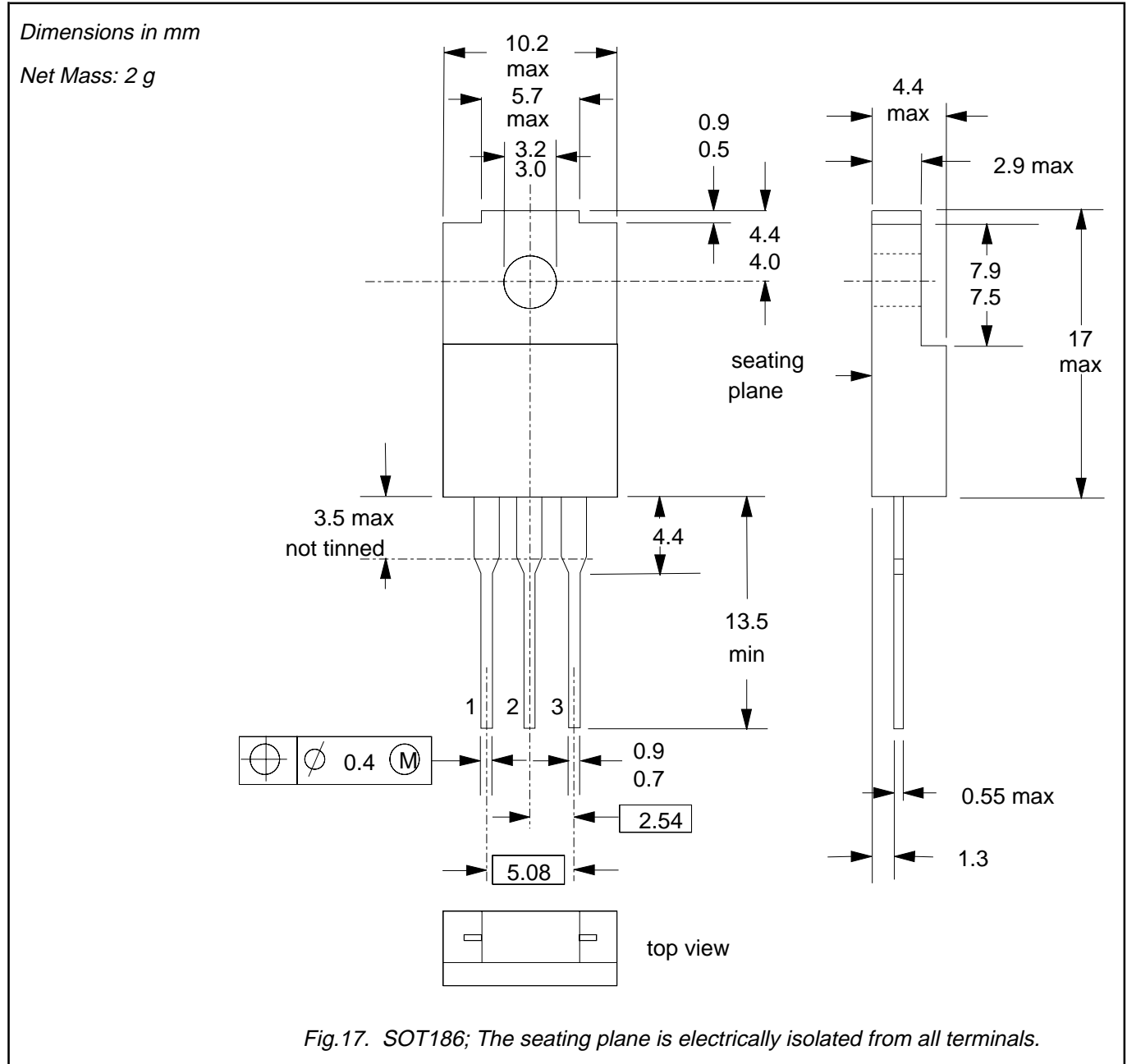

Notes

1. Observe the general handling precautions for electrostatic-discharge sensitive devices (ESDs) to prevent damage to MOS gate oxide.
2. Refer to mounting instructions for F-pack envelopes.
3. Epoxy meets UL94 V0 at 1/8".

PowerMOS transistor
Logic level FET

BUK545-100A/B

DEFINITIONS

| | |
|--|---|
| Data sheet status | |
| Objective specification | This data sheet contains target or goal specifications for product development. |
| Preliminary specification | This data sheet contains preliminary data; supplementary data may be published later. |
| Product specification | This data sheet contains final product specifications. |
| Limiting values | |
| Limiting values are given in accordance with the Absolute Maximum Rating System (IEC 134). Stress above one or more of the limiting values may cause permanent damage to the device. These are stress ratings only and operation of the device at these or at any other conditions above those given in the Characteristics sections of this specification is not implied. Exposure to limiting values for extended periods may affect device reliability. | |
| Application information | |
| Where application information is given, it is advisory and does not form part of the specification. | |
| © Philips Electronics N.V. 1996 | |
| All rights are reserved. Reproduction in whole or in part is prohibited without the prior written consent of the copyright owner. | |
| The information presented in this document does not form part of any quotation or contract, it is believed to be accurate and reliable and may be changed without notice. No liability will be accepted by the publisher for any consequence of its use. Publication thereof does not convey nor imply any license under patent or other industrial or intellectual property rights. | |

LIFE SUPPORT APPLICATIONS

These products are not designed for use in life support appliances, devices or systems where malfunction of these products can be reasonably expected to result in personal injury. Philips customers using or selling these products for use in such applications do so at their own risk and agree to fully indemnify Philips for any damages resulting from such improper use or sale.

- 1) Level: Format Error
Message: Page break required with Keep enabled
Location: Document Body



LittleDiode supplies new, hard to find or obsolete electronic components and semiconductors all over the world.

With over two million different components listed you are sure to find the part you need.

Feel free to visit us today at our online store:

LittleDiode.com

Looking forward to providing you with the best possible service.