

SIEMENS AKTIENGESELLSCHAFT

Main ratings

Drain-source voltage $V_{DS} = 400\text{ V}$
 Continuous drain current $I_D = 4,5\text{ A}$
 Drain-source on-resistance $R_{DS(on)} = 1,5\ \Omega$

N-Channel

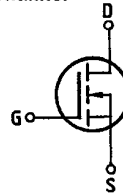

Description SIPMOS, N-channel, enhancement mode
Case Plastic package 14 A 3 in accordance with DIN 41 869,
 or TO 220 AB in accordance with JEDEC.
 The drain terminal is conductively connected to the mounting flange.
 Approx. weight 2 g

Type	Ordering code
BUZ 60 B	C67078-A1312-A4

Not for new design

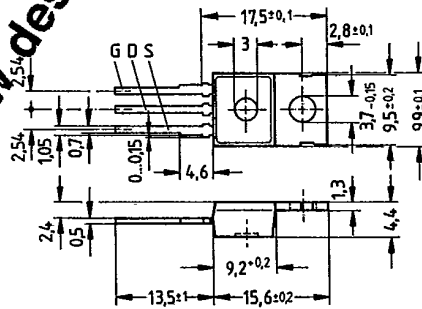

Dimensions in mm

Maximum ratings

Description	Symbols	Ratings	Units	Conditions
Drain-source voltage	V_{DS}	400	V	
Drain-gate voltage	V_{DGR}	400	V	$R_{GS} = 20\text{ k}\Omega$
Continuous drain current	I_D	4,5	A	$T_C = 35\text{ }^\circ\text{C}$
Pulsed drain current	$I_{D,puls}$	18	A	$T_C = 25\text{ }^\circ\text{C}$
Gate-source voltage	V_{GS}	± 20	V	
Max. power dissipation	P_D	75	W	$T_C = 25\text{ }^\circ\text{C}$
Operating and storage temperature range	T_j T_{stg}	- 55 ... + 150	°C	
DIN humidity category		E	-	DIN 40 040
IEC climatic category		55/150/56	-	DIN IEC 68-1

Thermal resistance

Chip - case	$R_{th,JC}$	≤ 1,67	K/W
Chip - ambient	$R_{th,JA}$	≤ 75	K/W

406 Preferred Type

0988

A-03

Electrical characteristics(at $T_j = 25^\circ\text{C}$ unless otherwise specified)

Description	Symbol	Characteristics			Unit	Conditions
		min.	typ.	max.		

Static ratings

Drain-source breakdown voltage	$V_{(BR)DSS}$	400	—	—	V	$V_{GS} = 0V$ $I_D = 0,25mA$
Gate threshold voltage	$V_{GS(th)}$	2,1	3,0	4,0		$V_{DS} = V_{GS}$ $I_D = 1mA$
Zero gate voltage drain current	I_{DSS}	—	20 100	250 1000	μA	$T_j = 25^\circ\text{C}$ $T_j = 125^\circ\text{C}$ $V_{DS} = 400V$ $V_{GS} = 0V$
Gate-source leakage current	I_{GSS}	—	10	100	nA	$V_{GS} = 20V$ $V_{DS} = 0V$
Drain-source on-resistance	$R_{DS(on)}$	—	1,2	1,5	Ω	$V_{GS} = 10V$ $I_D = 2,5A$

Dynamic ratings

Forward transconductance	g_{fs}	1,7	2,5	—	S	$V_{DS} = 25V$ $I_D = 2,5A$
Input capacitance	C_{iss}	—	1,5	2,0	nF	$V_{GS} = 0V$
Output capacitance	C_{oss}	—	120	180	pF	$V_{DS} = 25V$ $f = 1MHz$
Reverse transfer capacitance	C_{rss}	—	35	60		
Turn-on time t_{on} ($t_{on} = t_{d(on)} + t_r$)	$t_{d(on)}$	—	30	45	ns	$V_{CC} = 30V$ $I_D = 2,6A$
	t_r	—	40	60		$V_{GS} = 10V$
Turn-off time t_{off} ($t_{off} = t_{d(off)} + t_f$)	$t_{d(off)}$	—	110	140		$R_{GS} = 50\Omega$
	t_f	—	50	65		

Reverse diode

Continuous reverse drain current	I_{DR}	—	1,7	4,5	A	$T_C = 25^\circ\text{C}$
Pulsed reverse drain current	I_{DRM}	—	—	18		
Diode forward on-voltage	V_{SD}	—	1,15	1,50	V	$I_F = 2 \times I_{DR}$ $V_{GS} = 0V, T_j = 25^\circ\text{C}$
Reverse recovery time	t_{rr}	—	1000	—	ns	$T_j = 25^\circ\text{C}$
Reverse recovery charge	Q_{rr}	—	5	—	μC	$I_F = I_{DR}$ $dI_F/dt = 100A/\mu s$ $V_R = 100V$

Power dissipation $P_D = f(T_C)$

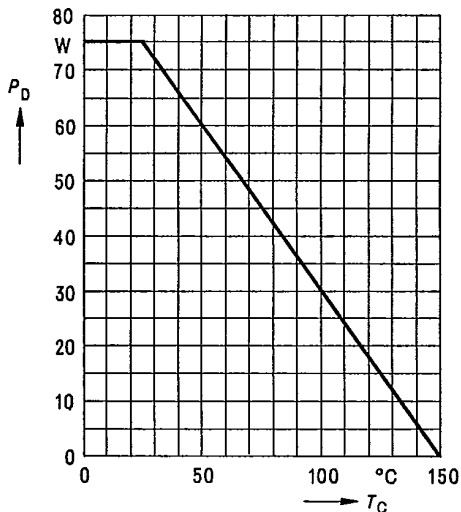

Typical output characteristics $I_D = f(V_{DS})$
parameter: 80 μ s pulse test,
 $T_J = 25^\circ\text{C}$

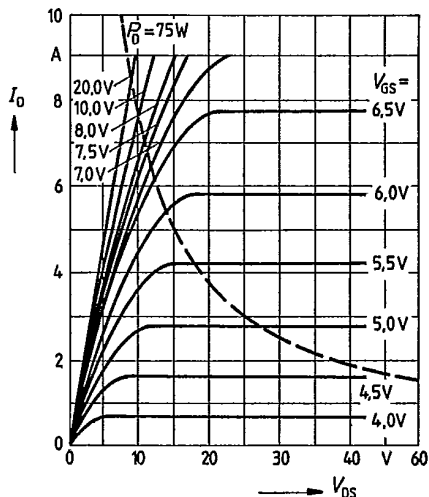

Safe operating area $I_D = f(V_{GS})$
parameter: $D = 0.01$, $T_C = 25^\circ\text{C}$

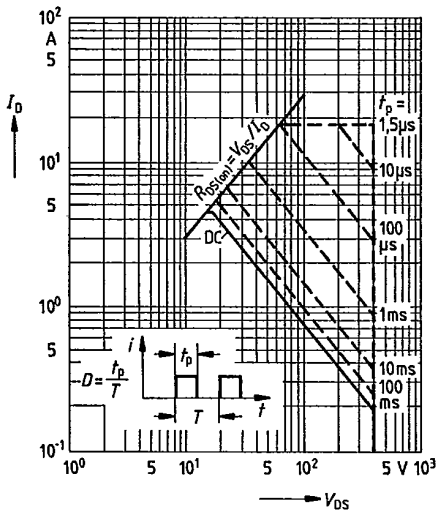

Typical transfer characteristic $I_D = f(V_{GS})$
parameter: 80 μ s pulse test,
 $V_{DS} = 25\text{V}$, $T_J = 25^\circ\text{C}$

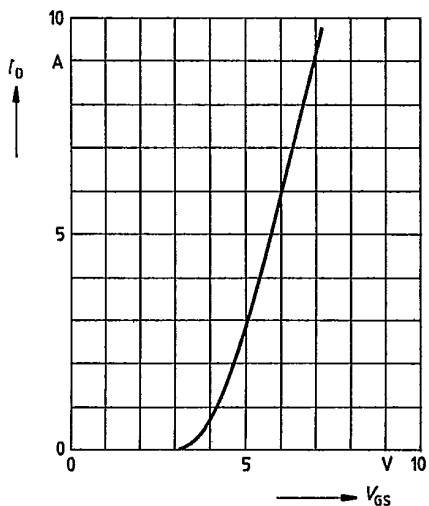

Typical drain-source on-state resistance

$R_{DS(on)} = f(I_D)$
parameter: $V_{GS} = 10V, T_j = 25^\circ C$

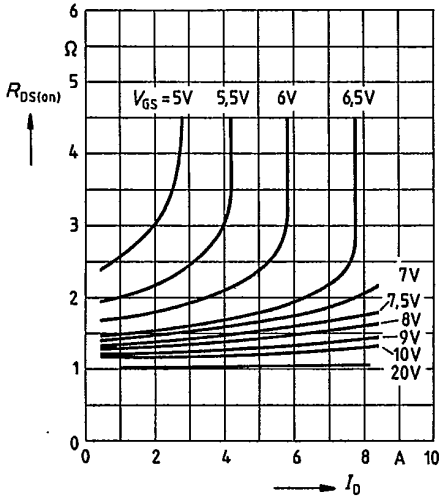

Drain-source on-state resistance

$R_{DS(on)} = f(T_j)$
parameter: $I_D = 2.5A, V_{GS} = 10V$
(spread)

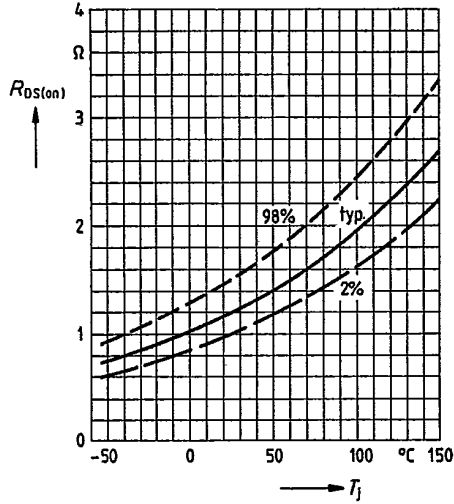

Typical transconductance $g_{fs} = f(I_D)$

parameter: 80 μs pulse test,
 $V_{DS} = 25V, T_j = 25^\circ C$

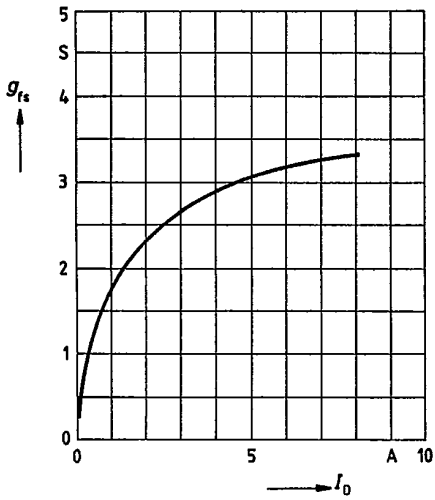

Gate threshold voltage $V_{GS(th)} = f(T_j)$

parameter: $V_{DS} = V_{GS}, I_D = 1mA$
(spread)

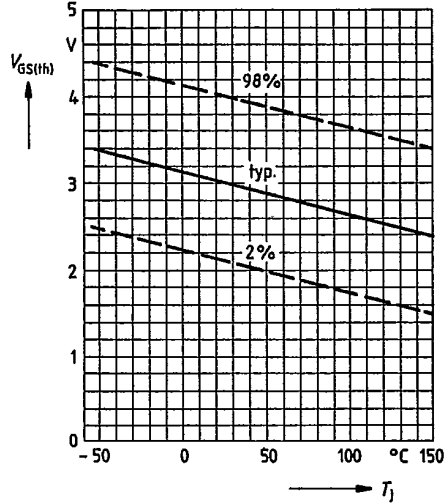

Typical capacitances $C = f(V_{DS})$
parameter: $V_{GS} = 0, f = 1\text{MHz}$

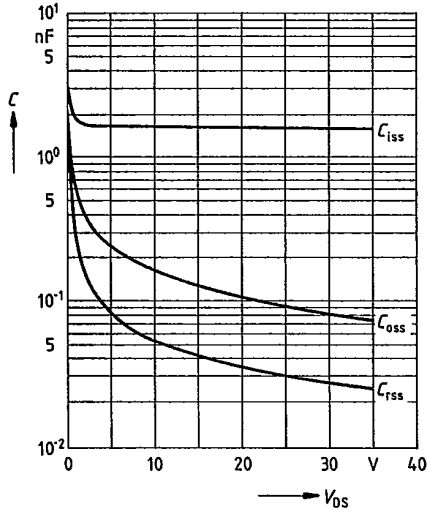

Continuous drain current $I_D = f(T_C)$
parameter: $V_{GS} \geq 10\text{V}$

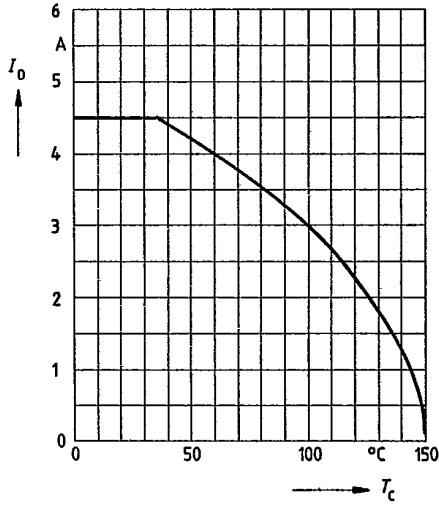

Forward characteristic of reverse diode
 $I_F = f(V_{SD})$
parameter: $T_j, t_p = 80 \mu\text{s}$
(spread)

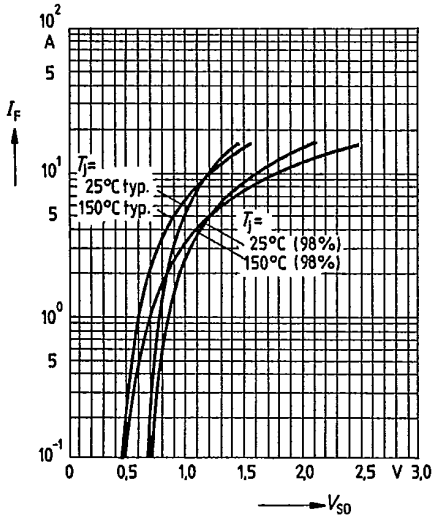

410

0992

A-07

Transient thermal impedance $Z_{thJC} = f(t)$
 parameter: $D = t_p / T$

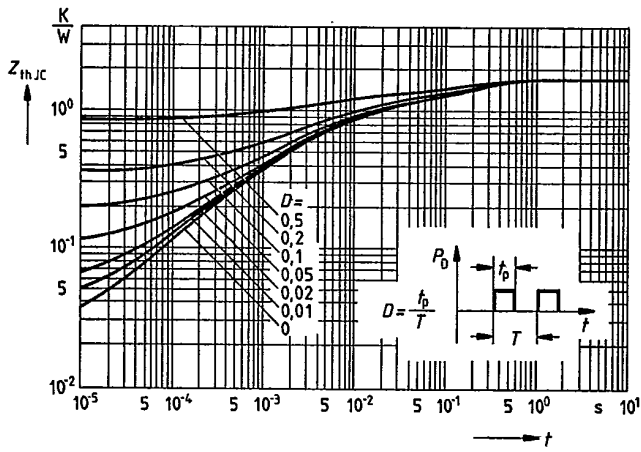

Typical gate-charge $V_{GS} = f(Q_{Gate})$
 parameter: $I_{D\ pulse} = 8.3A$

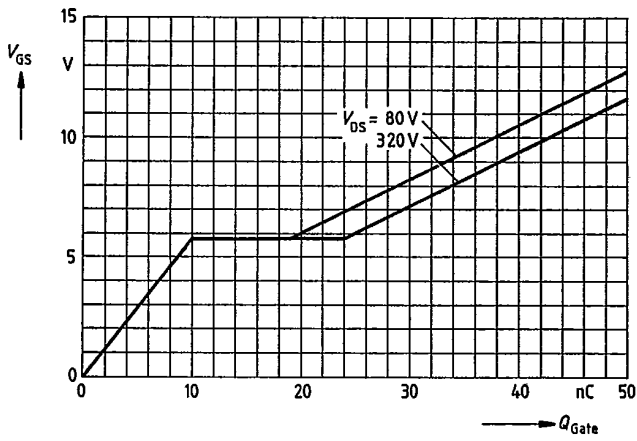



LittleDiode supplies new, hard to find or obsolete electronic components and semiconductors all over the world.

With over two million different components listed you are sure to find the part you need.

Feel free to visit us today at our online store:

LittleDiode.com

Looking forward to providing you with the best possible service.