

CNX35U CNX36U CNX38U CNX39U

## DESCRIPTION

The CNX35U, CNX36U, CNX38U and CNX39U are optically coupled isolators consisting of an infrared emitting GaAs diode and a silicon NPN phototransistor with accessible base. These devices are housed in 6-pin dual-in-line packages (DIP).

## FEATURES

- High output/input DC current transfer ratio
- Low saturation voltage
- UL recognized (File # E90700)
- VDE recognized (File # 94766)
- Ordering option '300' (e.g. CNX35U.300)

## APPLICATIONS

- Power supply regulators
- Digital logic inputs
- Microprocessor inputs
- Appliance sensor systems
- Industrial controls

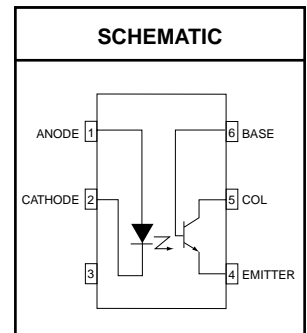
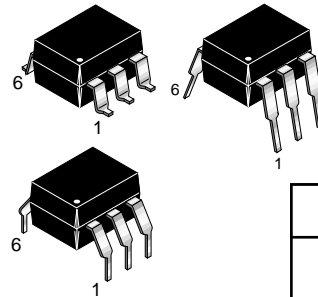

Parameters	Symbol	Device	Value	Units
<b>TOTAL DEVICE</b>				
Storage Temperature	$T_{STG}$	All	-55 to +150	°C
Operating Temperature	$T_{OPR}$	All	-40 to +100	°C
Lead Solder Temperature	$T_{SOL}$	All	260 for 10 sec	°C
<b>EMITTER</b>				
Continuous Reverse Voltage	$V_R$	All	5	V
Continuous Forward Current	$I_F$	All	100	mA
Forward Current - Peak (10 $\mu$ s pulse, $\delta = 0.01$ )	$I_F(pk)$	All	3.0	A
Total Power Dissipation up to 25°C Ambient Derate Linearly from 25°C	$P_D$	All	200	mW
		All	2.0	mW/°C
<b>DETECTOR</b>				
Collector to Emitter Voltage (open base)	$V_{CEO}$	CNX38U	80	V
		CNX35U, CNX36U, CNX39U	30	
Collector to Base Voltage (open emitter)	$V_{CBO}$	CNX38U	120	V
		CNX35U, CNX36U, CNX39U	70	
Emitter to Collector Voltage (open base)	$V_{ECO}$	All	7	V
DC Collector Current	$I_C$	All	100	mA
Detector Power Dissipation up to 25°C Ambient Derate Linearly from 25°C	$P_D$	All	200	mW
		All	2.0	mW/°C

CNX35U CNX36U CNX38U CNX39U

**ELECTRICAL CHARACTERISTICS** ( $T_A = 25^\circ\text{C}$  Unless otherwise specified.)

**INDIVIDUAL COMPONENT CHARACTERISTICS**

Parameters	Test Conditions	Symbol	Device	Min	Typ	Max	Units	
<b>EMITTER</b>								
Input Forward Voltage	$I_F = 10\text{ mA}$	$V_F$	All		1.15	1.5	V	
Reverse Current	$V_R = 5\text{ V}$	$I_R$	All			10	$\mu\text{A}$	
<b>DETECTOR</b>								
Leakage Current Collector to Emitter	$V_{CE} = 10\text{ V}$	$I_{CEO}$	CNX35U, CNX36U, CNX39U		2	50	nA	
	$V_{CE} = 50\text{ V}$		CNX38U		2	50	nA	
	$V_{CE} = 10\text{ V}, T_A = 70^\circ\text{C}$		CNX35U, CNX36U, CNX39U				10	$\mu\text{A}$
	$V_{CE} = 50\text{ V}, T_A = 70^\circ\text{C}$		CNX38U				10	$\mu\text{A}$
		$V_{CE} = 10\text{ V}$	$I_{CBO}$	All			20	nA
<b>Breakdown Voltage</b>								
Collector to Emitter	$I_C = 1\text{ mA}, I_F = 0$	$BV_{CEO}$	CNX35U, CNX36U, CNX39U	30			V	
			CNX38U	80				
Collector to Base	$I_C = 0.1\text{ mA}, I_F = 0$	$BV_{CBO}$	CNX35U, CNX36U, CNX39U	70			V	
			CNX38U	120				
Emitter to Collector	$I_E = 0.1\text{ mA}, I_F = 0$	$BV_{ECO}$	All	7			V	

**ISOLATION CHARACTERISTICS**

Characteristic	Test Conditions	Symbol	Min	Typ	Max	Units
Input-Output Isolation Voltage	$t = 1\text{ min.}$	$V_{ISO}$	5,300			$V_{RMS}$
Isolation Resistance	$V_{I-O} = 500\text{ VDC}$	$R_{ISO}$	1	10		$T\Omega$
Isolation Capacitance	$I_F = 0, V = 0V, f = 1\text{ MHz}$	$C_{ISO}$		0.6	1.3	pF

**CNX35U CNX36U CNX38U CNX39U**

<b>TRANSFER CHARACTERISTICS</b> ( $T_A = 25^\circ\text{C}$ Unless otherwise specified.)							
<b>DC Characteristics</b>	<b>Test Conditions</b>	<b>Symbol</b>	<b>Device</b>	<b>Min</b>	<b>Typ</b>	<b>Max</b>	<b>Units</b>
Output/Input Current Transfer Ratio	$I_F = 10\text{ mA}, V_{CE} = 0.4\text{ V}$	CTR	CNX35U	40		160	%
			CNX39U	60		100	
	CNX36U		80		200		
	CNX38U		70		210		
			50				
$I_F = 2\text{ mA}, V_{CE} = 5\text{ V}$	All	15					
Collector-Emitter Saturation Voltage	$I_F = 10\text{ mA}, I_C = 2\text{ mA}$	$V_{CE(SAT)}$	CNX35U, CNX39U		0.15	0.4	V
	$I_F = 10\text{ mA}, I_C = 4\text{ mA}$		CNX36U		0.19	0.4	
	$I_F = 16\text{ mA}, I_C = 2\text{ mA}$		CNX38U		0.2	0.4	
<b>AC Characteristics</b>	<b>Test Conditions</b>	<b>Symbol</b>	<b>Device</b>	<b>Min</b>	<b>Typ</b>	<b>Max</b>	<b>Units</b>
Non-Saturated Switching Times Turn-On Time See Fig. 1 and Fig. 2	$R_L = 100\ \Omega, I_C = 2\text{ mA}, V_{CC} = 5\text{ V}$	$t_{on}$	CNX35U			20	$\mu\text{s}$
	$R_L = 100\ \Omega, I_C = 4\text{ mA}, V_{CC} = 5\text{ V}$		CNX39U			20	
Turn-Off Time See Fig. 1 and Fig. 2		$R_L = 100\ \Omega, I_C = 2\text{ mA}, V_{CC} = 5\text{ V}$	CNX36U			20	
	CNX38U				20		
Saturated Switching Times Turn-On Time See Fig. 1 and Fig. 2	$R_L = 1\text{ k}\Omega, I_C = 2\text{ mA}, V_{CC} = 5\text{ V}$	$t_{on}$	CNX35U			50	$\mu\text{s}$
	$R_L = 1\text{ k}\Omega, I_C = 4\text{ mA}, V_{CC} = 5\text{ V}$		CNX39U			50	
Turn-Off Time See Fig. 1 and Fig. 2		$R_L = 1\text{ k}\Omega, I_C = 2\text{ mA}, V_{CC} = 5\text{ V}$	CNX36U			50	
	CNX38U				50		
	$R_L = 1\text{ k}\Omega, I_C = 4\text{ mA}, V_{CC} = 5\text{ V}$	$t_{off}$	CNX35U			50	$\mu\text{s}$
			CNX39U			50	
			CNX36U			50	
			CNX38U			50	

CNX35U CNX36U CNX38U CNX39U

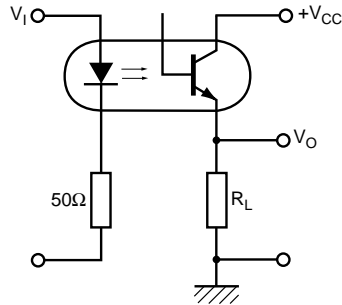

Fig. 1 Switching Test Circuit

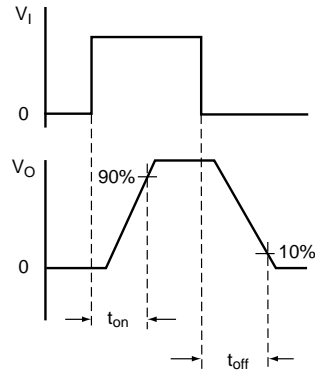

Fig. 2 Switching Test Waveforms

Fig. 3 LED Forward Voltage vs. Forward Current

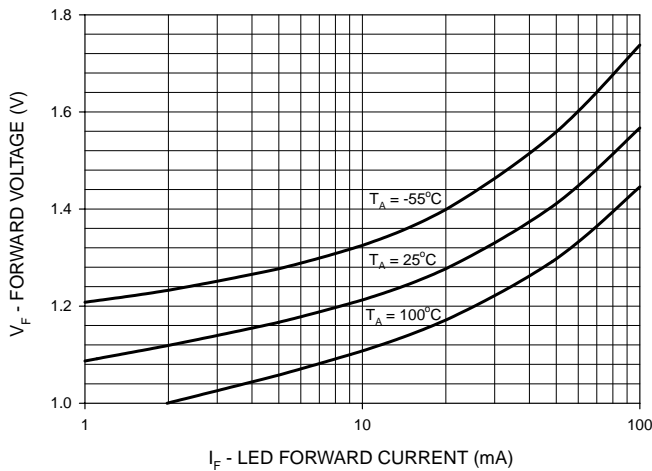

Fig. 4 Normalized CTR vs. Forward Current

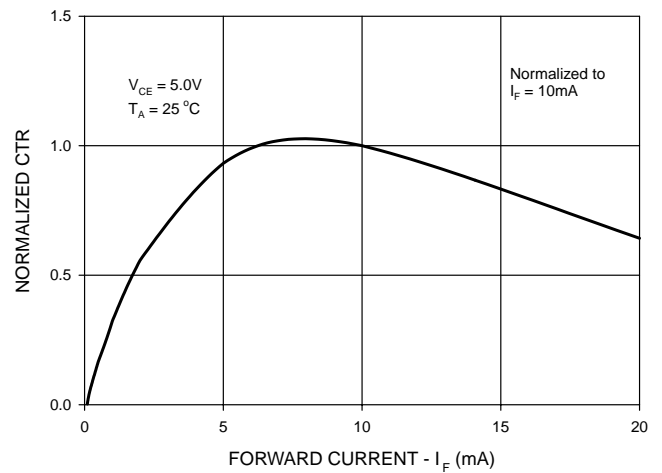

Fig. 5 Normalized CTR vs. Temperature

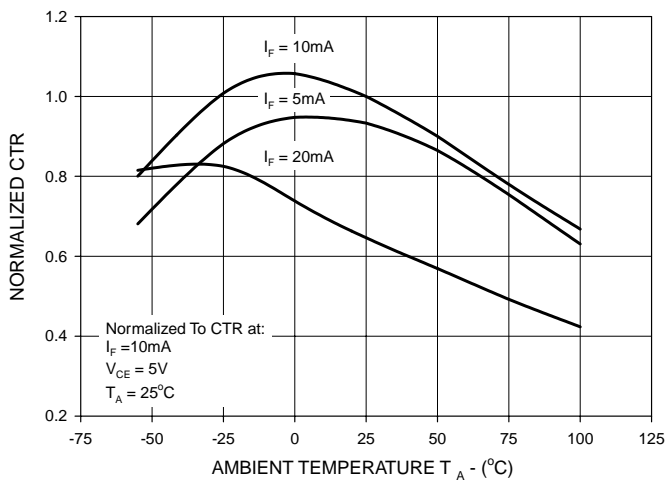
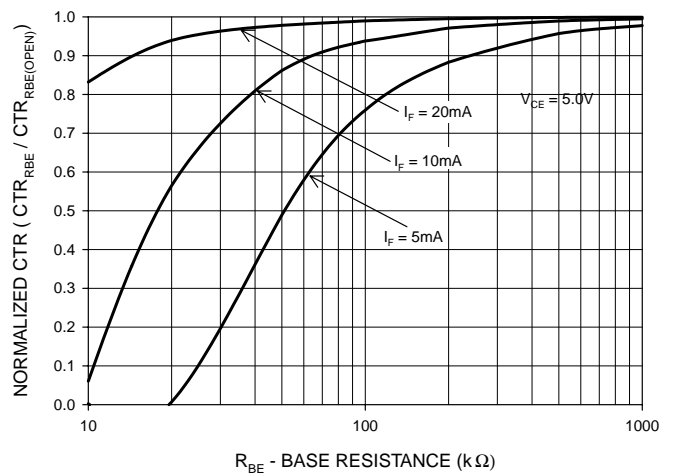
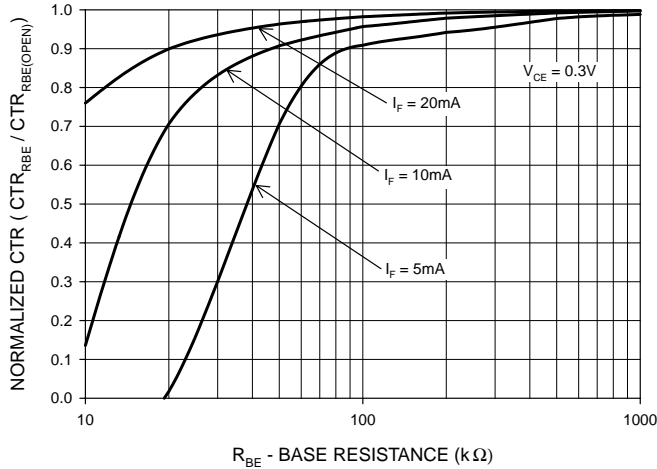

Fig. 6 CTR vs. R\_BE (Unsaturated)



CNX35U CNX36U CNX38U CNX39U

**Fig. 7 CTR vs. R<sub>BE</sub> (Saturated)**



**Fig. 8 Normalized t<sub>on</sub> vs. R<sub>BE</sub>**

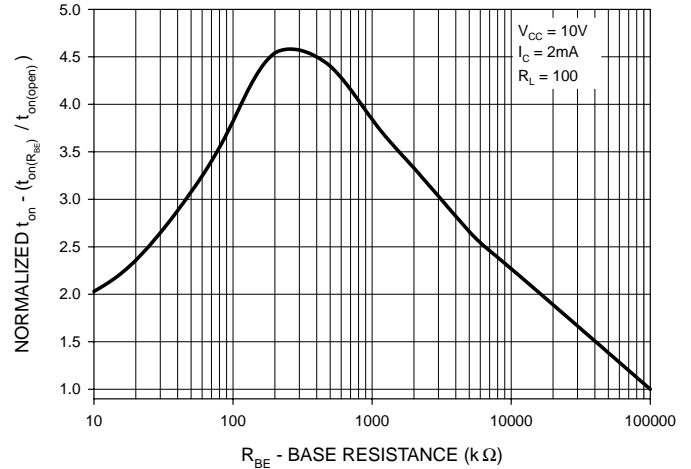

**Fig. 9 Normalized t<sub>off</sub> vs. R<sub>BE</sub>**

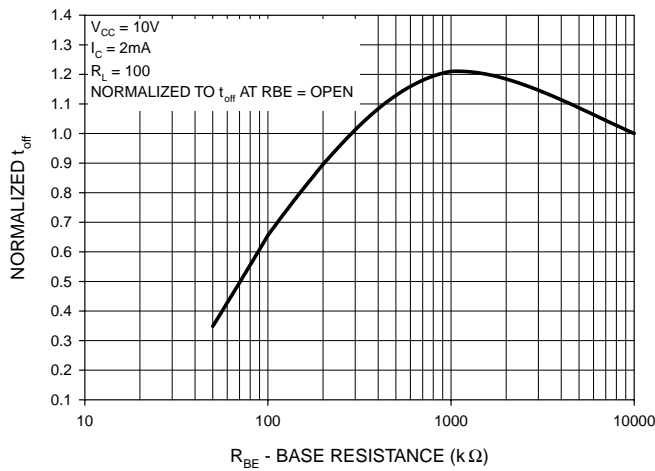

**Fig. 10 Switching Speed vs. Load Resistor**

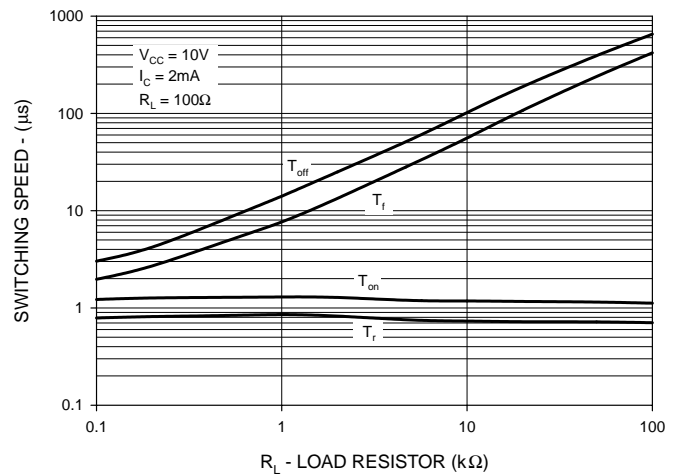

**Fig. 11 Collector-Emitter Saturation Voltage as a Function of Collector Current**

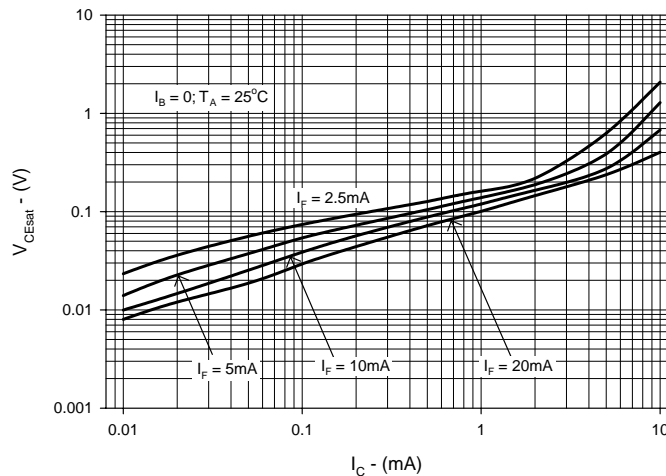



CNX35U CNX36U CNX38U CNX39U

**ORDERING INFORMATION**

Option	Order Entry Identifier	Description
S	.S	Surface Mount Lead Bend
SD	.SD	Surface Mount; Tape and reel
W	.W	0.4" Lead Spacing
300	.300	VDE 0884
300W	.300W	VDE 0884, 0.4" Lead Spacing
3S	.3S	VDE 0884, Surface Mount
3SD	.3SD	VDE 0884, Surface Mount, Tape & Reel

**Carrier Tape Specifications ("D" Taping Orientation)**

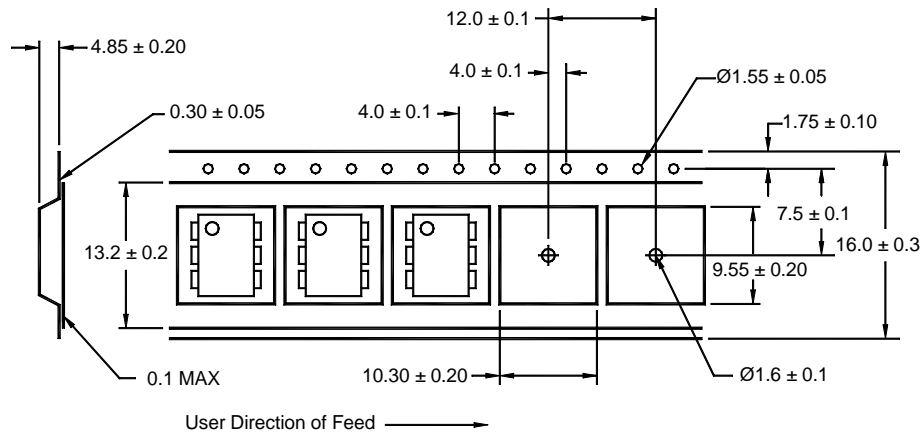

**NOTE**

All dimensions are in inches (millimeters)

**DISCLAIMER**

FAIRCHILD SEMICONDUCTOR RESERVES THE THE RIGHT TO MAKE CHANGES WITHOUT FURTHER NOTICE TO ANY PRODUCTS HEREIN TO IMPROVE RELIABILITY, FUNCTION OR DESIGN. FAIRCHILD DOES NOT ASSUME ANY LIABILITY ARISING OUT OF THE APPLICATION OR USE OF ANY PRODUCT OR CIRCUIT DESCRIBED HEREIN; NEITHER DOES IT CONVEY ANY LICENSE UNDER ITS PATENT RIGHTS, NOR THE RIGHTS OF OTHERS.

**LIFE SUPPORT POLICY**

FAIRCHILD'S PRODUCTS ARE NOT AUTHORIZED FOR USE AS CRITICAL COMPONENTS IN LIFE SUPPORT DEVICES OR SYSTEMS WITHOUT THE EXPRESS WRITTEN APPROVAL OF THE PRESIDENT OF FAIRCHILD SEMICONDUCTOR CORPORATION. As used herein:

1. Life support devices or systems are devices or systems which, (a) are intended for surgical implant into the body, or (b) support or sustain life, and (c) whose failure to perform when properly used in accordance with instructions for use provided in labeling, can be reasonably expected to result in a significant injury of the user.
2. A critical component in any component of a life support device or system whose failure to perform can be reasonably expected to cause the failure of the life support device or system, or to affect its safety or effectiveness.



LittleDiode supplies new, hard to find or obsolete electronic components and semiconductors all over the world.

With over two million different components listed you are sure to find the part you need.

Feel free to visit us today at our online store:

[LittleDiode.com](http://LittleDiode.com)

Looking forward to providing you with the best possible service.