

6-PIN DIP OPTOCOUPLERS FOR POWER SUPPLY APPLICATIONS (NO BASE CONNECTION)

MOC8101	MOC8102	MOC8103	MOC8104
MOC8105	MOC8106	MOC8107	MOC8108
CNY17F-1	CNY17F-2	CNY17F-3	CNY17F-4

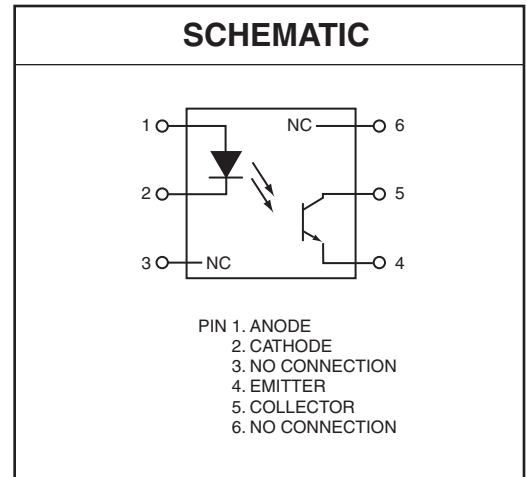
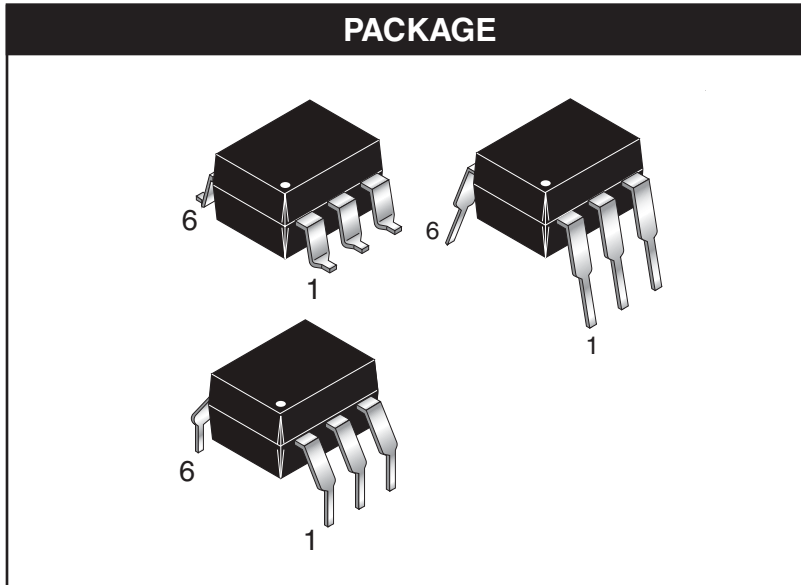

FEATURES

The MOC810X and CNY17F-X devices consist of a gallium arsenide LED optically coupled to a silicon phototransistor in a dual-in-line package.

- Closely Matched Current Transfer Ratio (CTR) Minimizes Unit-to-Unit Variation
- Narrow (CTR) Windows that Translate to a Narrow and Predictable Open Loop Gain Window
- Very Low Coupled Capacitance along with No Chip to Pin 6 Base Connection for Minimum Noise Susceptibility
- **To order devices that are tested and marked per VDE 0884 requirements, the suffix ".300" must be included at the end of part number. e.g. MOC8101.300 VDE 0884 is a test option.**

APPLICATIONS

- Switchmode Power Supplies (Feedback Control)
- AC Line/Digital Logic Isolation
- Interfacing and coupling systems of different potentials and impedances

**6-PIN DIP OPTOCOUPLEDERS FOR
POWER SUPPLY APPLICATIONS
(NO BASE CONNECTION)**

MOC8101	MOC8102	MOC8103	MOC8104
MOC8105	MOC8106	MOC8107	MOC8108
CNY17F-1	CNY17F-2	CNY17F-3	CNY17F-4

ABSOLUTE MAXIMUM RATINGS ($T_A = 25^\circ\text{C}$ Unless otherwise specified)			
Parameter	Symbol	Value	Unit
INPUT LED			
Forward Current - Continuous	I_F	100	mA
Forward Current - Peak (PW = 1 μ s, 300pps)	$I_F(\text{pk})$	1	A
Reverse Voltage	V_R	6	Volts
LED Power Dissipation @ $T_A = 25^\circ\text{C}$	P_D	150	mW
Derate above 25 $^\circ\text{C}$		2.0	mW/ $^\circ\text{C}$
OUTPUT TRANSISTOR			
Collector-Emitter Voltage	V_{CEO}	70	Volts
MOC8106/7/8, CNY17F-1/2/3/4		30	
MOC8101/2/3/4/5			
Emitter-Collector Voltage	V_{ECO}	7	Volts
Detector Power Dissipation @ $T_A = 25^\circ\text{C}$	P_D	150	mW
Derate above 25 $^\circ\text{C}$		2.0	mW/ $^\circ\text{C}$
TOTAL DEVICE			
Input-Output Isolation Voltage (f = 60 Hz, t = 1 min.)	V_{ISO}	5300	Vac(rms)
Total Device Power Dissipation @ $T_A = 25^\circ\text{C}$	P_D	250	mW
Derate above 25 $^\circ\text{C}$		3.3	mW/ $^\circ\text{C}$
Ambient Operating Temperature Range	T_{OPR}	-55 to +100	$^\circ\text{C}$
Storage Temperature Range	T_{STG}	-55 to +150	$^\circ\text{C}$
Lead Soldering Temperature (1/16" from case, 10 sec. duration)	T_{SOL}	260	$^\circ\text{C}$

MOC8101	MOC8102	MOC8103	MOC8104
MOC8105	MOC8106	MOC8107	MOC8108
CNY17F-1	CNY17F-2	CNY17F-3	CNY17F-4

ELECTRICAL CHARACTERISTICS ($T_A = 25^\circ\text{C}$ Unless otherwise specified) ⁽¹⁾						
Characteristic	Symbol	Min	Typ**	Max	Unit	
INPUT LED						
Forward Voltage	($I_F = 60\text{ mA}$)	CNY17F-X	V_F	—	1.40	V
	($I_F = 10\text{ mA}$)	MOC810X		1.0	1.18	
Reverse Leakage Current ($V_R = 5.0\text{ V}$)		I_R	—	0.001	10	μA
Capacitance		C	—	18	—	pF
OUTPUT TRANSISTOR						
Collector-Emitter Dark Current	($V_{CE} = 10\text{ V}, T_A = 25^\circ\text{C}$)	I_{CEO1}	—	1.0	50	nA
	($V_{CE} = 10\text{ V}, T_A = 100^\circ\text{C}$)	I_{CEO2}	—	1.0	—	μA
Collector-Emitter Breakdown Voltage	MOC8101/2/3/4/5	($I_C = 1.0\text{ mA}$)	$V_{(BR)CEO}$	30	100	V
	MOC8106/7/8, CNY17F-1/2/3/4	($I_C = 1.0\text{ mA}$)		70	100	
Emitter-Collector Breakdown Voltage	($I_E = 100\text{ }\mu\text{A}$)	$V_{(BR)ECO}$	7.0	10	—	V
Collector-Emitter Capacitance	($f = 1.0\text{ MHz}, V_{CE} = 0$)	C_{CE}	—	8	—	pF
COUPLED						
Output Collector Current ($I_F = 10\text{ mA}, V_{CE} = 10\text{ V}$)	MOC8101	(CTR) ⁽²⁾	50	—	80	%
	MOC8102		73	—	117	
	MOC8103		108	—	173	
	MOC8104		160	—	256	
	MOC8105		65	—	133	
	MOC8106		50	—	150	
	MOC8107		100	—	300	
	MOC8108		250	—	600	
(I _F = 10 mA, V _{CE} = 5 V)	CNY17F-1	40	—	80		
	CNY17F-2	63	—	125		
	CNY17F-3	100	—	200		
	CNY17F-4	160	—	320		
Collector-Emitter Saturation Voltage		$V_{CE(sat)}$	—	—	0.4	V
CNY17F-1/2/3/4	($I_C = 2.5\text{ mA}, I_F = 10\text{ mA}$)					
	MOC8101/2/3/4/5/6/7/8	($I_C = 500\text{ }\mu\text{A}, I_F = 5.0\text{ mA}$)				
Isolation Voltage	($f = 60\text{ Hz}, t = 1.0\text{ min.}$) ⁽⁴⁾	V_{ISO}	5300	—	—	Vac(rms)
Isolation Resistance	($V_{I-O} = 500\text{ V}$) ⁽⁴⁾	R_{ISO}	10^{11}	—	—	Ω
Isolation Capacitance	($V_{I-O} = 0, f = 1.0\text{ MHz}$) ⁽⁴⁾	C_{ISO}	—	0.5	—	pF

** All typicals at $T_A = 25^\circ\text{C}$

MOC8101	MOC8102	MOC8103	MOC8104
MOC8105	MOC8106	MOC8107	MOC8108
CNY17F-1	CNY17F-2	CNY17F-3	CNY17F-4

TRANSFER CHARACTERISTICS ($T_A = 25^\circ\text{C}$ Unless otherwise specified)						
AC Characteristic	Test Conditions	Symbol	Min	Typ**	Max	Unit
NON-SATURATED SWITCHING TIME						
Turn-on Time CNY17F-1/2/3/4 Only	($R_L = 100 \Omega$, $I_C = 2 \text{ mA}$)	t_{on}	—	2	10	μs
Turn-off Time CNY17F-1/2/3/4 Only	($V_{CC} = 10 \text{ V}$)	t_{off}	—	3	10	
Turn-On Time	MOC8101-5 MOC8106-8 ($I_C = 2.0 \text{ mA}$, $V_{CC} = 10 \text{ V}$, $R_L = 100 \Omega$) ⁽³⁾	t_{on}	—	2	20	μs
					—	
Turn-Off Time	MOC8101-5 MOC8106-8 ($I_C = 2.0 \text{ mA}$, $V_{CC} = 10 \text{ V}$, $R_L = 100 \Omega$) ⁽³⁾	t_{off}	—	3	20	
					—	
Rise Time	All Devices ($I_C = 2.0 \text{ mA}$, $V_{CC} = 10 \text{ V}$, $R_L = 100 \Omega$) ⁽³⁾	t_r	—	1	—	μs
All Devices						
Fall Time	All Devices ($I_C = 2.0 \text{ mA}$, $V_{CC} = 10 \text{ V}$, $R_L = 100 \Omega$) ⁽³⁾	t_f	—	2	—	μs
All Devices						
SATURATED SWITCHING TIMES						
Turn-on Time	CNY17F-1 ($I_F = 20 \text{ mA}$, $V_{CE} = 0.4 \text{ V}$)	t_{on}	—	—	5.5	μs
CNY17F-2 CNY17F-3 CNY17F-4					($I_F = 10 \text{ mA}$, $V_{CE} = 0.4 \text{ V}$)	
Rise Time	CNY17F-1 ($I_F = 20 \text{ mA}$, $V_{CE} = 0.4 \text{ V}$)	t_r	—	—	4.0	μs
CNY17F-2 CNY17F-3 CNY17F-4					($I_F = 20 \text{ mA}$, $V_{CE} = 0.4 \text{ V}$)	
Turn-off Time	CNY17F-1 ($I_F = 20 \text{ mA}$, $V_{CE} = 0.4 \text{ V}$)	t_{off}	—	—	34	μs
CNY17F-2 CNY17F-3 CNY17F-4					($I_F = 10 \text{ mA}$, $V_{CE} = 0.4 \text{ V}$)	
Fall Time	CNY17F-1 ($I_F = 20 \text{ mA}$, $V_{CE} = 0.4 \text{ V}$)	t_f	—	—	20	μs
CNY17F-2 CNY17F-3 CNY17F-4					($I_F = 10 \text{ mA}$, $V_{CE} = 0.4 \text{ V}$)	

** All typicals at $T_A = 25^\circ\text{C}$

NOTES:

1. Always design to the specified minimum/maximum electrical limits (where applicable).
2. Current Transfer Ratio (CTR) = $I_C/I_F \times 100\%$.
3. For test circuit setup and waveforms, refer to Figure 11.
4. For this test, Pins 1 and 2 are common, and Pins 4 and 5 are common.

MOC8101	MOC8102	MOC8103	MOC8104
MOC8105	MOC8106	MOC8107	MOC8108
CNY17F-1	CNY17F-2	CNY17F-3	CNY17F-4

TYPICAL PERFORMANCE CURVES

Fig. 1 LED Forward Voltage vs. Forward Current

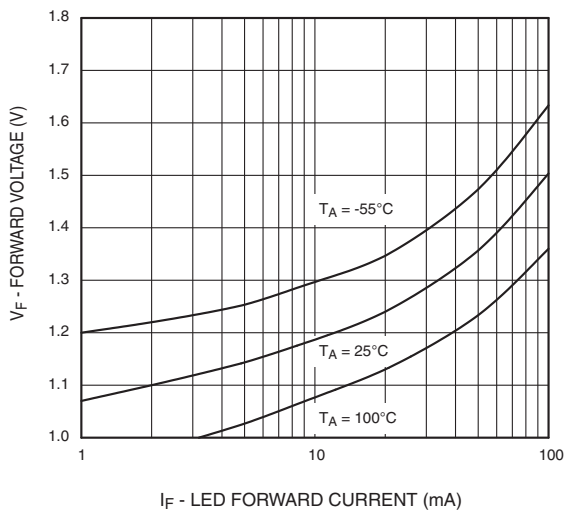

Fig. 2 Normalized CTR vs. Forward Current

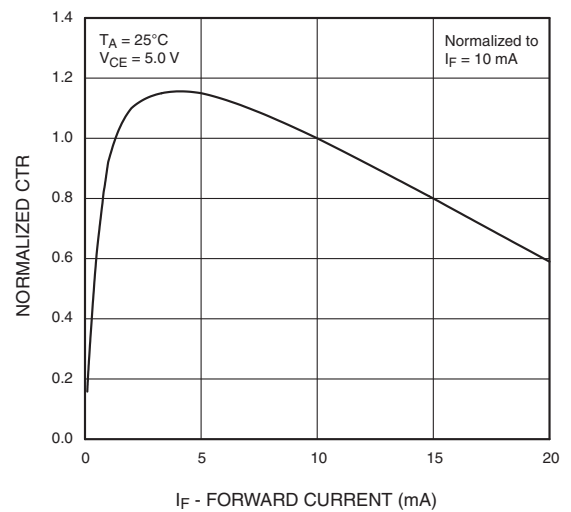

Fig. 3 Normalized CTR vs. Ambient Temperature

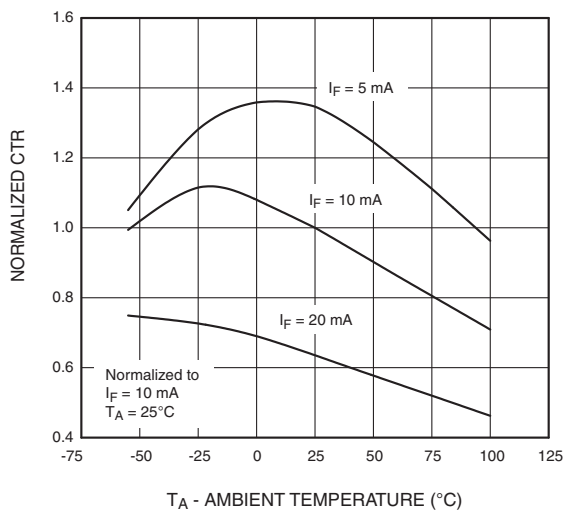
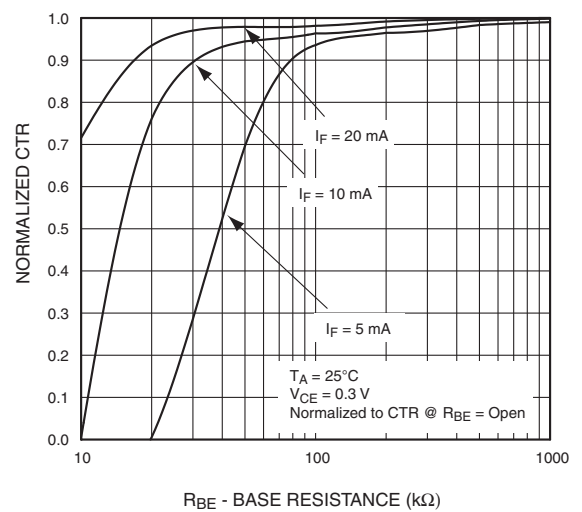

Fig. 4 CTR vs. RBE (Saturated)



MOC8101	MOC8102	MOC8103	MOC8104
MOC8105	MOC8106	MOC8107	MOC8108
CNY17F-1	CNY17F-2	CNY17F-3	CNY17F-4

TYPICAL PERFORMANCE CURVES (continued)

Fig. 5 CTR vs. R_{BE} (Unsaturated)

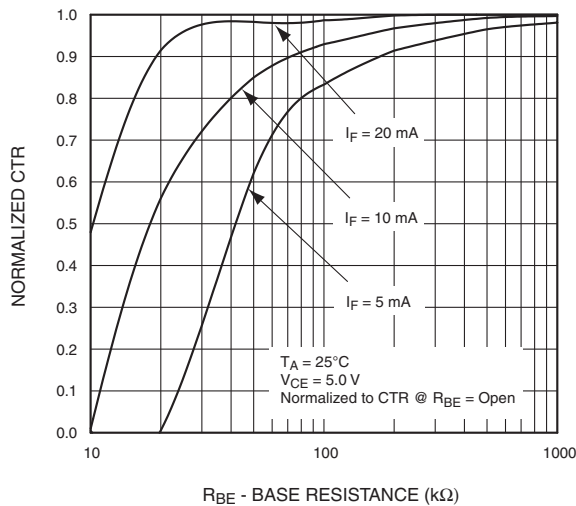

Fig. 6 Collector Emitter Saturation Voltage vs Collector Current

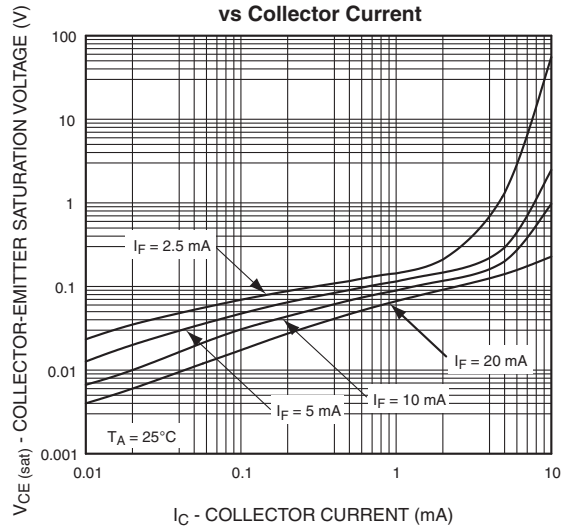

Fig. 7 Normalized t_{on} vs. R_{BE}

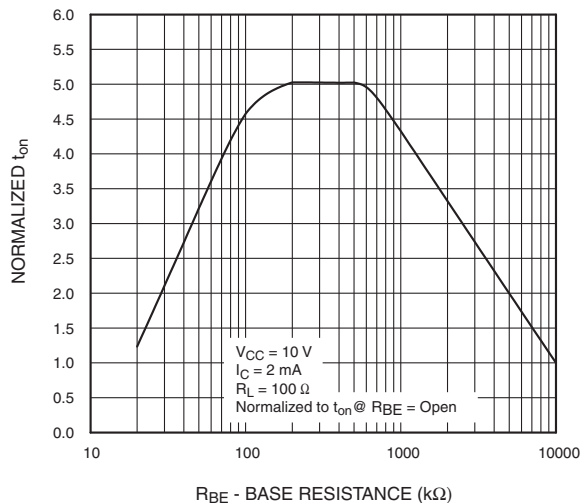
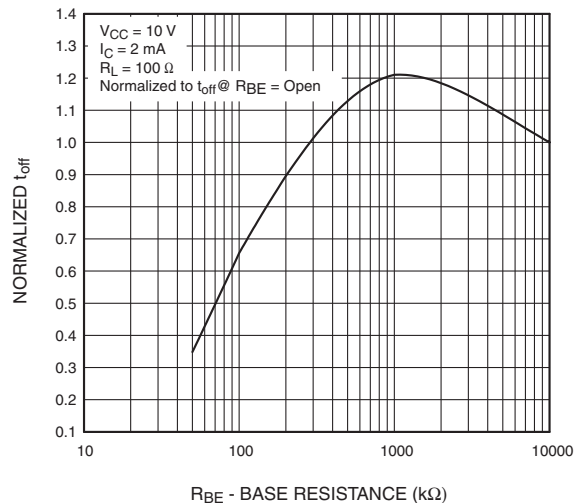

Fig. 8 Normalized t_{off} vs. R_{BE}



MOC8101	MOC8102	MOC8103	MOC8104
MOC8105	MOC8106	MOC8107	MOC8108
CNY17F-1	CNY17F-2	CNY17F-3	CNY17F-4

TYPICAL PERFORMANCE CURVES (continued)

Fig. 9 Switching Speed vs. Load Resistor

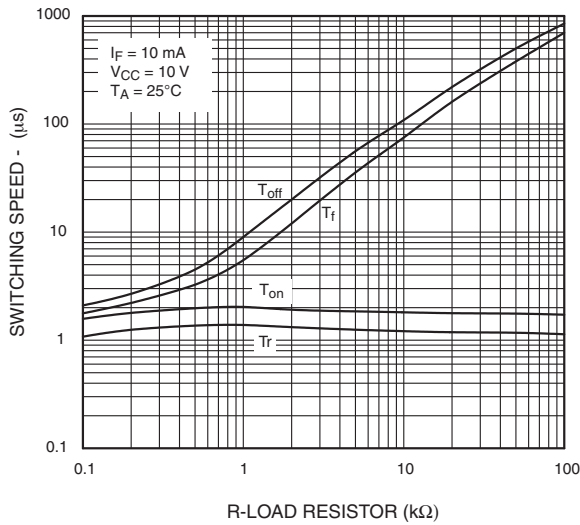
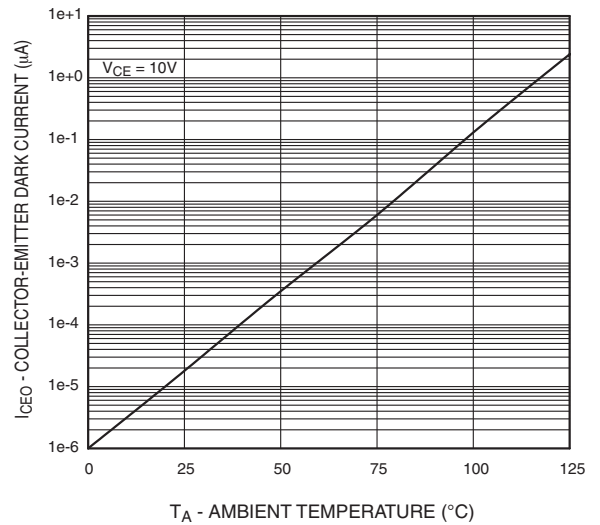
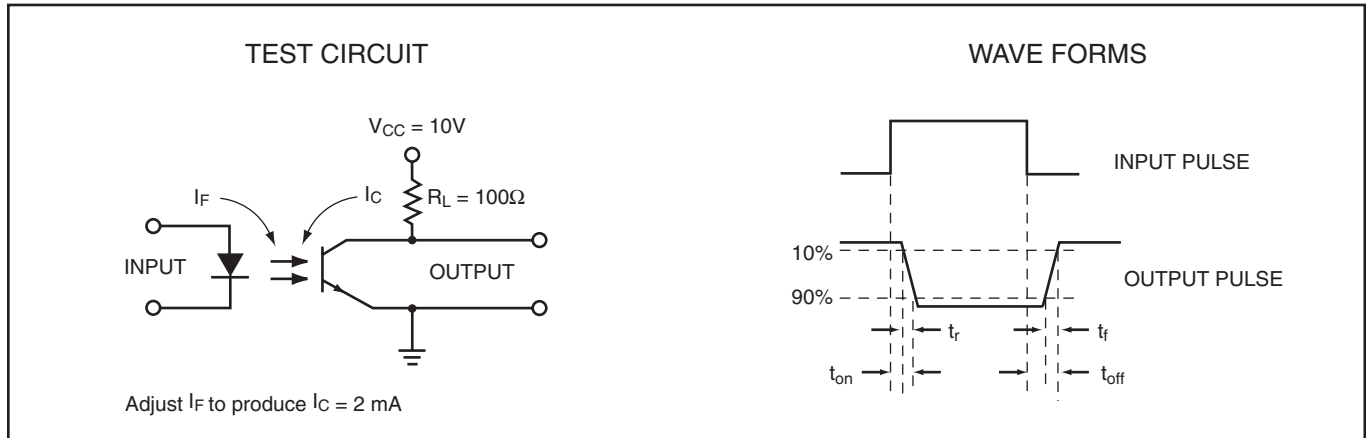

Fig. 10 Dark current vs. Ambient Temperature.



MOC8101	MOC8102	MOC8103	MOC8104
MOC8105	MOC8106	MOC8107	MOC8108
CNY17F-1	CNY17F-2	CNY17F-3	CNY17F-4

Figure 11. Switching Time Test Circuit and Waveforms



6-PIN DIP OPTOCOUPPLERS FOR POWER SUPPLY APPLICATIONS (NO BASE CONNECTION)

MOC8101	MOC8102	MOC8103	MOC8104
MOC8105	MOC8106	MOC8107	MOC8108
CNY17F-1	CNY17F-2	CNY17F-3	CNY17F-4

ORDERING INFORMATION

Option	Order Entry Identifier	Description
S	.S	Surface Mount Lead Bend
SD	.SD	Surface Mount; Tape and Reel
W	.W	0.4" Lead Spacing
300	.300	VDE 0884
300W	.300W	VDE 0884, 0.4" Lead Spacing
3S	.3S	VDE 0884, Surface Mount
3SD	.3SD	VDE 0884, Surface Mount, Tape and Reel

MARKING INFORMATION

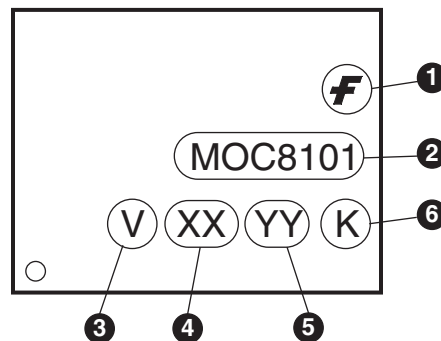

Definitions	
1	Fairchild logo
2	Device number
3	VDE mark (Note: Only appears on parts ordered with VDE option – See order entry table)
4	Two digit year code, e.g., '03'
5	Two digit work week ranging from '01' to '53'
6	Assembly package code

MOC8101	MOC8102	MOC8103	MOC8104
MOC8105	MOC8106	MOC8107	MOC8108
CNY17F-1	CNY17F-2	CNY17F-3	CNY17F-4

Carrier Tape Specifications ("D" Taping Orientation)

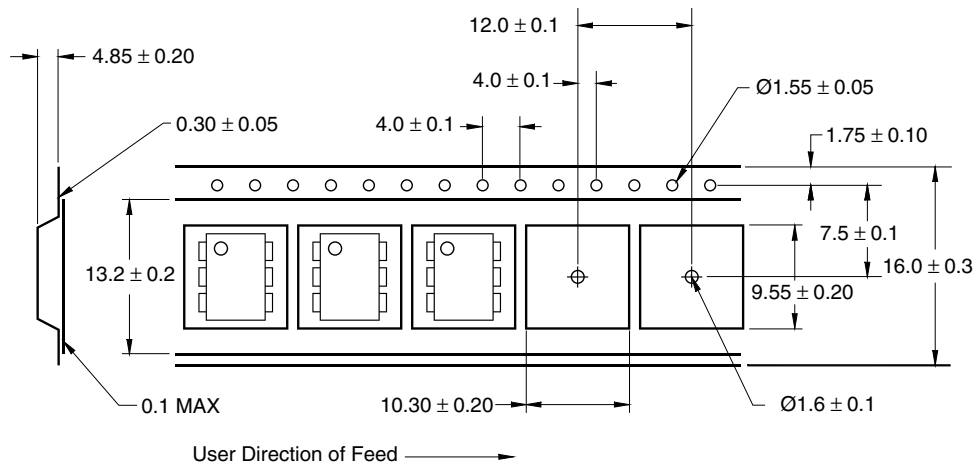

NOTE

All dimensions are in inches (millimeters)

Reflow Profile (Black Package, No Suffix)

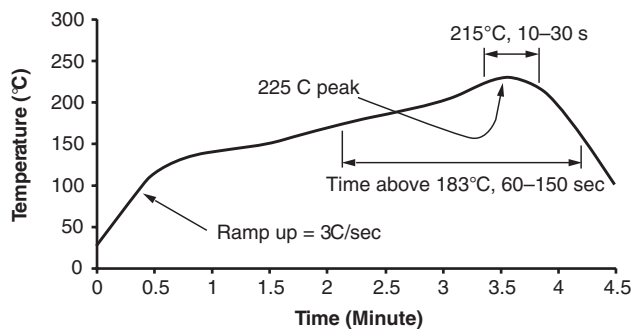

- Peak reflow temperature: 225°C (package surface temperature)
- Time of temperature higher than 183°C for 60–150 seconds
- One time soldering reflow is recommended

MOC8101	MOC8102	MOC8103	MOC8104
MOC8105	MOC8106	MOC8107	MOC8108
CNY17F-1	CNY17F-2	CNY17F-3	CNY17F-4

DISCLAIMER

FAIRCHILD SEMICONDUCTOR RESERVES THE RIGHT TO MAKE CHANGES WITHOUT FURTHER NOTICE TO ANY PRODUCTS HEREIN TO IMPROVE RELIABILITY, FUNCTION OR DESIGN. FAIRCHILD DOES NOT ASSUME ANY LIABILITY ARISING OUT OF THE APPLICATION OR USE OF ANY PRODUCT OR CIRCUIT DESCRIBED HEREIN; NEITHER DOES IT CONVEY ANY LICENSE UNDER ITS PATENT RIGHTS, NOR THE RIGHTS OF OTHERS.

LIFE SUPPORT POLICY

FAIRCHILD'S PRODUCTS ARE NOT AUTHORIZED FOR USE AS CRITICAL COMPONENTS IN LIFE SUPPORT DEVICES OR SYSTEMS WITHOUT THE EXPRESS WRITTEN APPROVAL OF THE PRESIDENT OF FAIRCHILD SEMICONDUCTOR CORPORATION. As used herein:

1. Life support devices or systems are devices or systems which, (a) are intended for surgical implant into the body, or (b) support or sustain life, and (c) whose failure to perform when properly used in accordance with instructions for use provided in the labeling, can be reasonably expected to result in a significant injury of the user.
2. A critical component in any component of a life support device or system whose failure to perform can be reasonably expected to cause the failure of the life support device or system, or to affect its safety or effectiveness.



LittleDiode supplies new, hard to find or obsolete electronic components and semiconductors all over the world.

With over two million different components listed you are sure to find the part you need.

Feel free to visit us today at our online store:

LittleDiode.com

Looking forward to providing you with the best possible service.