

## DS75114 Dual Differential Line Drivers

### General Description

The DS75114 dual differential line driver is designed to provide differential output signals with high current capability for driving balanced lines, such as twisted pair at normal line impedances, without high power dissipation. The output stages are similar to TTL totem-pole outputs, but with the sink outputs, YS and ZS, and the corresponding active pull-up terminals, YP and ZP, available on adjacent package pins. Since the output stages provide TTL compatible output levels, these devices may also be used as TTL expanders or phase splitters.

### Features

- Each circuit offers a choice of open-collector or active pull-up (totem-pole) outputs
- Single 5V supply
- Differential line operation
- Dual channels
- TTL/LS compatibility
- Designed to be interchangeable with Fairchild 9614 line drivers
- Short-circuit protection of outputs
- High current outputs
- Clamp diodes at inputs and outputs to terminate line transients
- Single-ended or differential AND/NAND outputs
- Triple inputs

### Connection Diagram

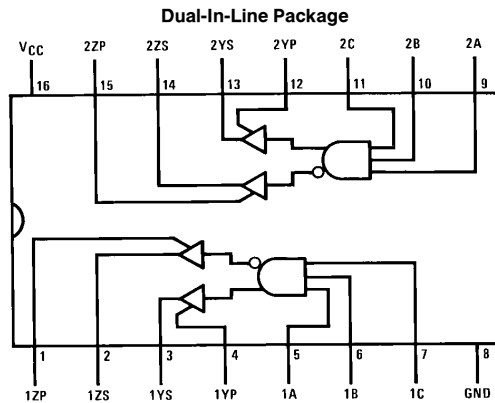

TL/F/5786-1

Positive logic:  $Y = ABC$

$Z = \overline{ABC}$

**Order Number DS75114N**  
See NS Package Number N16A

### Truth Table

Inputs			Outputs	
A	B	C	Y	Z
H	H	H	H	L
All Other Input Combinations			L	H

H = high level

L = low level

## Absolute Maximum Ratings (Note 1)

If Military/Aerospace specified devices are required, please contact the National Semiconductor Sales Office/Distributors for availability and specifications.

Supply Voltage ( $V_{CC}$ )	7V
Input Voltage	5.5V
OFF-State Voltage Applied to Open-Collector Outputs	12V
Maximum Power Dissipation* at 25°C	
Cavity Package	1433 mW
Molded Package	1362 mW
Operating Free-Air Temperature Range	
DS55114	-55°C to +125°C
DS75114	0°C to +70°C
Storage Temperature Range	-65°C to +150°C
Lead Temperature (1/16" from case for 60 seconds): J Package	300°C

Lead Temperature (1/16" from case for 4 seconds): N Package 260°C

\*Derate cavity package 9.6 mW/°C above 25°C; derate molded package 10.9 mW/°C above 25°C (Note 2).

## Operating Conditions

	Min	Max	Units
Supply Voltage ( $V_{CC}$ )			
DS75114	4.75	5.25	V
High Level Output Current ( $I_{OH}$ )		-40	mA
Low Level Output Current ( $I_{OL}$ )		40	mA
Operating Free-Air Temperature ( $T_A$ )			
DS75114	0	70	°C

## Electrical Characteristics Over recommended operating free-air temperature range (unless otherwise noted)

Symbol	Parameter	Conditions (Note 3)	DS75114			Units	
			Min	Typ (Note 4)	Max		
$V_{IH}$	High Level Input Voltage		2			V	
$V_{IL}$	Low Level Input Voltage				0.8	V	
$V_{IK}$	Input Clamp Voltage	$V_{CC} = \text{Min}, I_I = -12 \text{ mA}$		-0.9	-1.5	V	
$V_{OH}$	High Level Output Voltage	$V_{CC} = \text{Min}, V_{IH} = 2V$	$I_{OH} = -10 \text{ mA}$	2.4	3.4	V	
		$V_{IL} = 0.8V$	$I_{OH} = -40 \text{ mA}$	2	3.0		
$V_{OL}$	Low Level Output Voltage	$V_{CC} = \text{Min}, V_{IH} = 2V, V_{IL} = 0.8V, I_{OL} = 40 \text{ mA}$		0.2	0.45	V	
$V_{OK}$	Output Clamp Voltage	$V_{CC} = 5V, I_O = 40 \text{ mA}, T_A = 25^\circ\text{C}$		6.1	6.5	V	
		$V_{CC} = \text{Max}, I_O = -40 \text{ mA}, T_A = 25^\circ\text{C}$		-1.1	-1.5		
$I_{O(\text{off})}$	OFF-State Open-Collector Output Current	$V_{CC} = \text{Max}$	$V_{OH} = 12V$	$T_A = 25^\circ$		$\mu\text{A}$	
				$T_A = 125^\circ\text{C}$			
			$V_{OH} = 5.25V$	$T_A = 25^\circ\text{C}$	1		100
				$T_A = 70^\circ\text{C}$			200
$I_I$	Input Current at Maximum Input Voltage	$V_{CC} = \text{Max}, V_I = 5.5V$			1	mA	
$I_{IH}$	High Level Input Current	$V_{CC} = \text{Max}, V_I = 2.4V$			40	$\mu\text{A}$	
$I_{IL}$	Low Level Input Current	$V_{CC} = \text{Max}, V_I = 0.4V$		-1.1	-1.6	mA	
$I_{OS}$	Short-Circuit Output Current (Note 5)	$V_{CC} = \text{Max}, V_O = 0V$	-40	-90	-120	mA	
$I_{CC}$	Supply Current (Both Drivers)	Inputs Grounded, No Load, $T_A = 25^\circ\text{C}$	$V_{CC} = \text{Max}$	37	50	mA	
			$V_{CC} = 7V$	47	70		

Note 1: All voltage values are with respect to network ground terminal.

Note 2: For operation above 25°C free-air temperature, refer to Dissipation Derating Curves in the Thermal information section.

Note 3: All parameters, with the exception of OFF-state open-collector output current, are measured with the active pull-up connected to the sink output.

Note 4: All typical values are at  $T_A = 25^\circ\text{C}$  and  $V_{CC} = 5V$ , with the exception of  $I_{CC}$  at 7V.

Note 5: Only one output should be shorted at a time, and duration of the short-circuit should not exceed one second.

### Switching Characteristics $V_{CC} = 5V, T_A = 25^\circ C$

Symbol	Parameter	Conditions	DS75114			Units
			Min	Typ	Max	
$t_{PLH}$	Propagation Delay Time, Low-to-High-Level Output	$C_L = 30 \text{ pF}$ , (Figure 1)		15	30	ns
$t_{PHL}$	Propagation Delay Time High-to-Low-Level Output			11	30	ns

### AC Test Circuit and Switching Time Waveforms

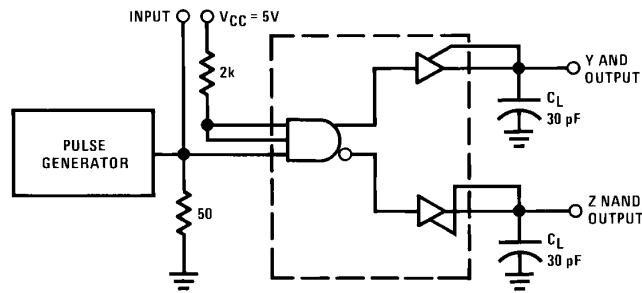

TL/F/5786-3

**Note 1:** The pulse generator has the following characteristics:  $Z_{OUT} = 50\Omega$ ,  $t_w = 100 \text{ ns}$ ,  $PRR = 500 \text{ kHz}$ .

**Note 2:**  $C_L$  includes probe and jig-capacitance.

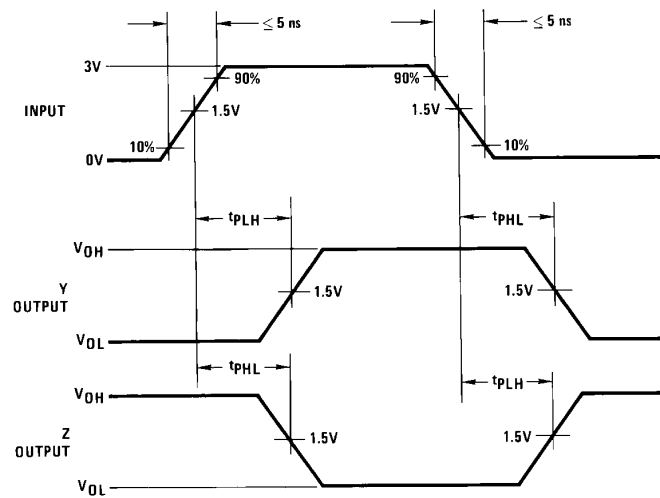
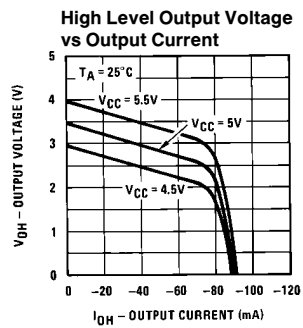
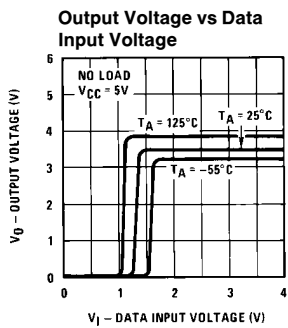
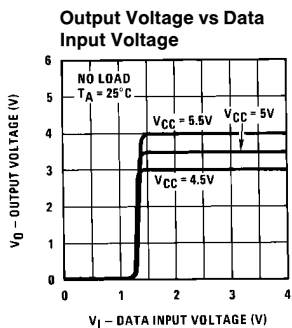

FIGURE 1. (Notes 1, 2)

TL/F/5786-4

# Typical Performance Characteristics\*



TL/F/5786-5

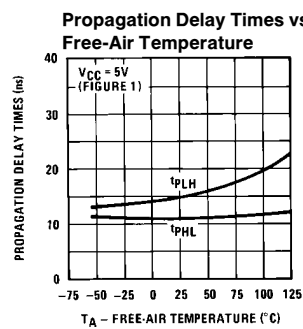
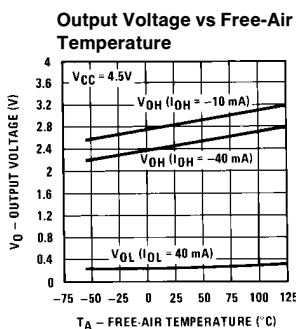
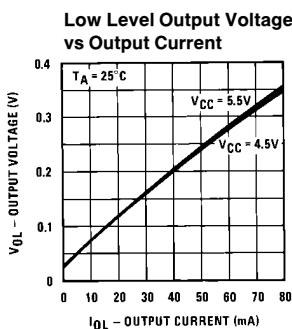

TL/F/5786-6

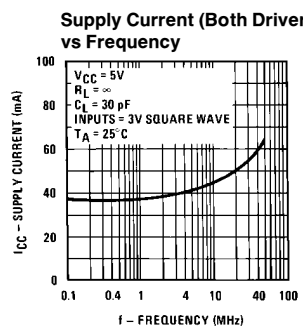
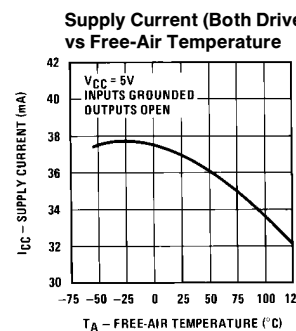
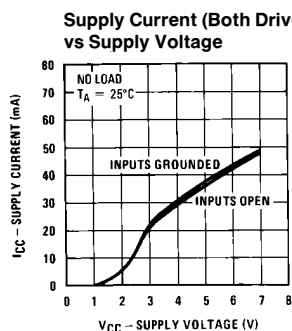

TL/F/5786-7

\*Data for temperatures below 0°C and above 70°C and for supply voltages below 4.75V and above 5.25V are applicable to DS55114 circuits only. These parameters were measured with the active pull-up connected to the sink output.

# Schematic Diagram (Each Driver)

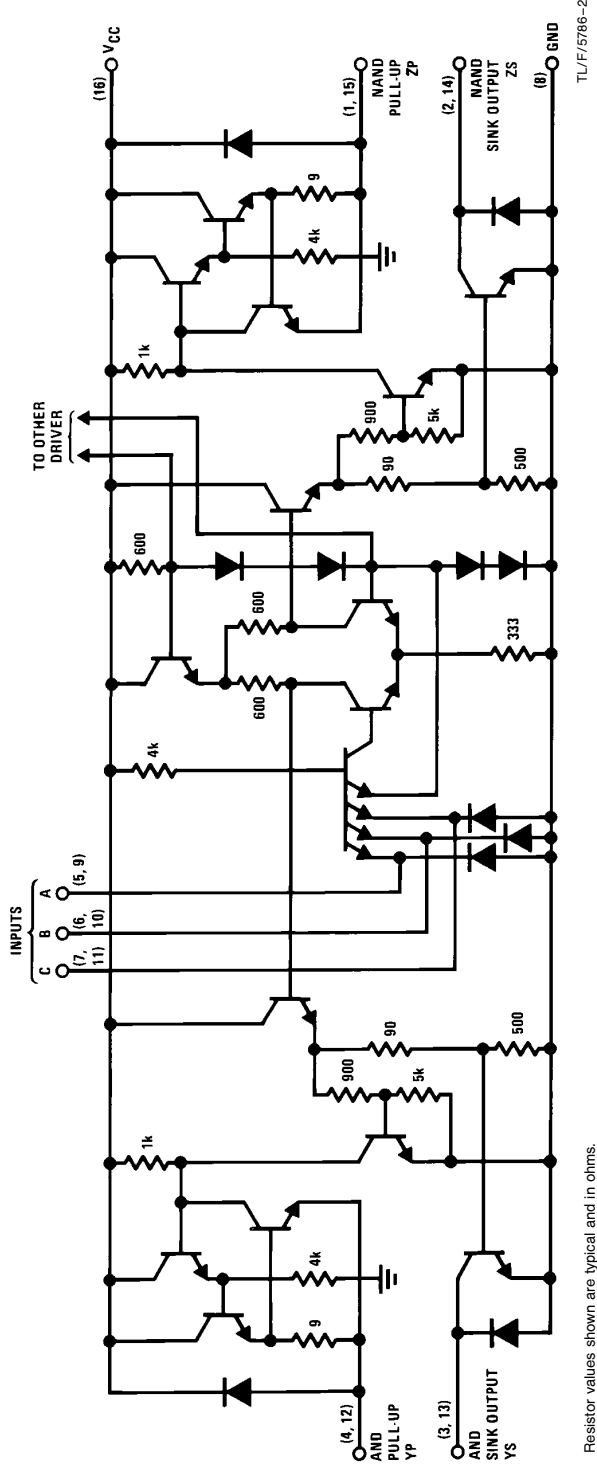

Resistor values shown are typical and in ohms.

**Physical Dimensions** inches (millimeters)

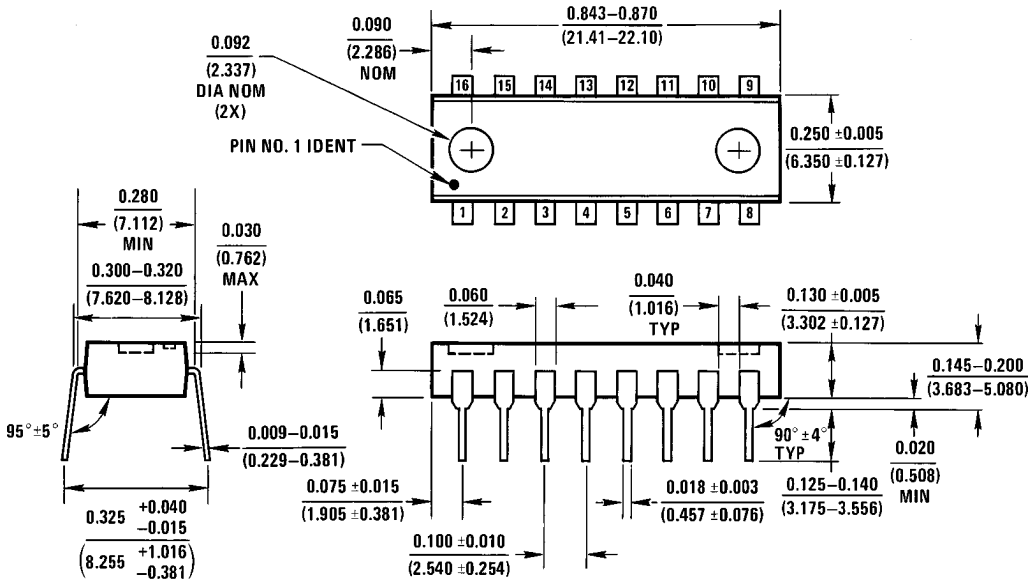

**Molded Dual-In-Line Package (N)**  
**Order Number DS75114N**  
**NS Package Number N16A**

N16A (REV E)

**LIFE SUPPORT POLICY**

NATIONAL'S PRODUCTS ARE NOT AUTHORIZED FOR USE AS CRITICAL COMPONENTS IN LIFE SUPPORT DEVICES OR SYSTEMS WITHOUT THE EXPRESS WRITTEN APPROVAL OF THE PRESIDENT OF NATIONAL SEMICONDUCTOR CORPORATION. As used herein:

1. Life support devices or systems are devices or systems which, (a) are intended for surgical implant into the body, or (b) support or sustain life, and whose failure to perform, when properly used in accordance with instructions for use provided in the labeling, can be reasonably expected to result in a significant injury to the user.
2. A critical component is any component of a life support device or system whose failure to perform can be reasonably expected to cause the failure of the life support device or system, or to affect its safety or effectiveness.



**National Semiconductor Corporation**  
 1111 West Bardin Road  
 Arlington, TX 76017  
 Tel: (800) 272-9959  
 Fax: (800) 737-7018

<http://www.national.com>

**National Semiconductor Europe**

Fax: +49 (0) 180-530 85 86  
 Email: [europe.support@nsc.com](mailto:europe.support@nsc.com)  
 Deutsch Tel: +49 (0) 180-530 85 85  
 English Tel: +49 (0) 180-532 78 32  
 Français Tel: +49 (0) 180-532 93 58  
 Italiano Tel: +49 (0) 180-534 16 80

**National Semiconductor Hong Kong Ltd.**

19th Floor, Straight Block,  
 Ocean Centre, 5 Canton Rd.  
 Tsimshatsui, Kowloon  
 Hong Kong  
 Tel: (852) 2737-1600  
 Fax: (852) 2736-9960

**National Semiconductor Japan Ltd.**

Tel: 81-043-299-2308  
 Fax: 81-043-299-2408

This datasheet has been downloaded from:

[www.DatasheetCatalog.com](http://www.DatasheetCatalog.com)

Datasheets for electronic components.

# National Semiconductor was acquired by Texas Instruments.

[http://www.ti.com/corp/docs/investor\\_relations/pr\\_09\\_23\\_2011\\_national\\_semiconductor.html](http://www.ti.com/corp/docs/investor_relations/pr_09_23_2011_national_semiconductor.html)

This file is the datasheet for the following electronic components:

DS75114N - <http://www.ti.com/product/ds75114n?HQS=TI-null-null-dscatalog-df-pf-null-ww>



LittleDiode supplies new, hard to find or obsolete electronic components and semiconductors all over the world.

With over two million different components listed you are sure to find the part you need.

Feel free to visit us today at our online store:

[LittleDiode.com](http://LittleDiode.com)

Looking forward to providing you with the best possible service.