

Damper Diodes (For Display)

Parameter Type No.	Absolute Maximum Ratings					Electrical Characteristics (Ta=25°C)							Others				
	V _{RM} (V)	I _{F(AV)} (A)	I _{FSM} (A) 50Hz Half-cycle Sinewave Single Shot	T _J (°C)	T _{stg} (°C)	V _F (V)		I _R (μA)	I _R (H) (μA) V _R =V _{RM} Ta=100°C max	t _{rr} (1) (μs)	t _{rr} (2) (μs)	R _{th(j-ℓ)} (°C/W)	Mass (g)	Fig.	Remarks		
						max	I _F (A)									I _F /I _{RP} (mA)	I _F /I _{RP} (mA)
FMP-G2FS	1500	5.0	50	-40 to +150		2.0	5.0	50	500 (T _J =150°C)	0.7	500/500	0.3	4.0	2.1	Ⓐ		
FMQ-G2FLS		10.0				1.8	10.0									0.5	0.4
FMQ-G2FS						2.8											
FMQ-G5FMS		2.4															
FMQ-G5GS	1700	8.0				2.7	100	100	250	1.0	500/1000	2.0	6.5	Ⓑ			
FMP-G5HS	1800					2.0	8.0								25	250	1.0
RG 2A2	1300	0.5	5	-40 to +150		3.5	0.5	100	500	0.1	100/100	0.05	100/200	12.0	0.6	Ⓒ For Compensation	
RC 3B2	1600	1.0	20			3.6	1.0										0.07

FMP-G2FS

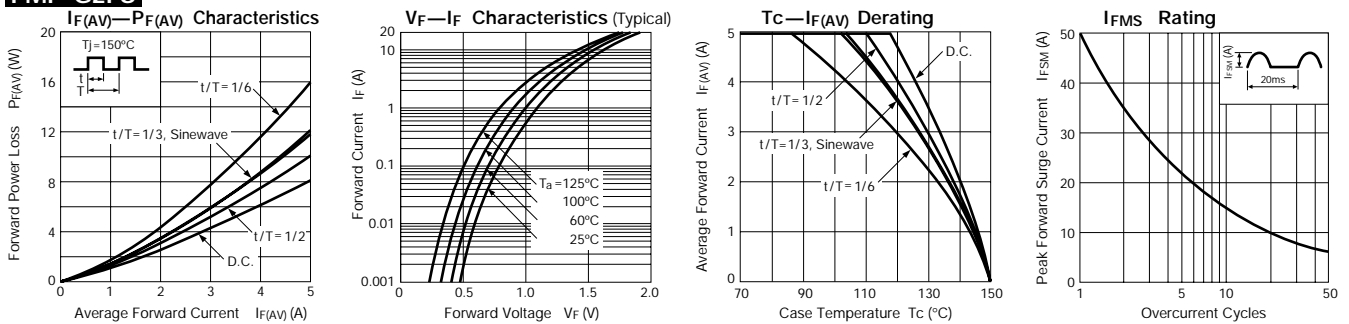

FMQ-G2FLS

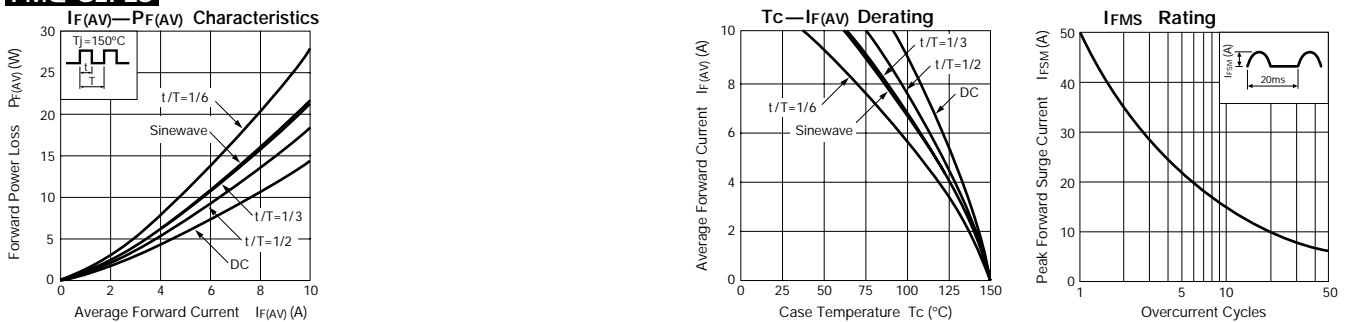

FMQ-G2FS

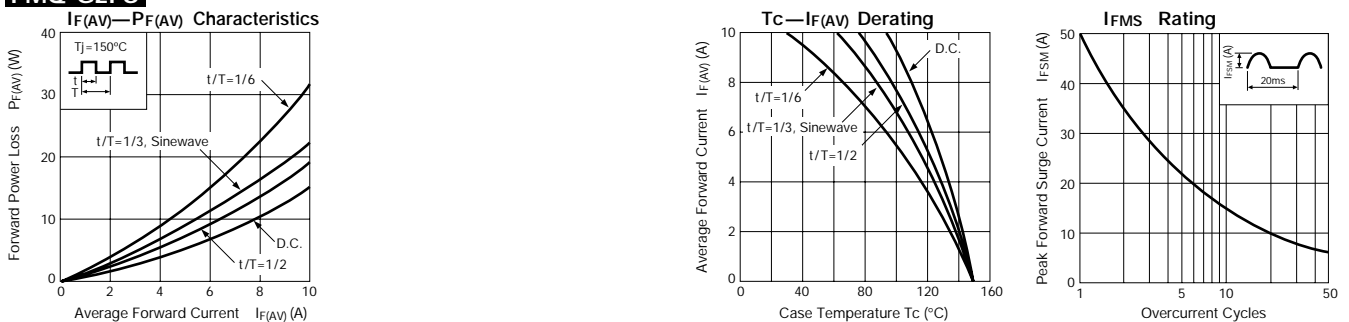

External Dimensions

(Unit: mm) (Full-mold)

Flammability:
UL94V-0 or Equivalent

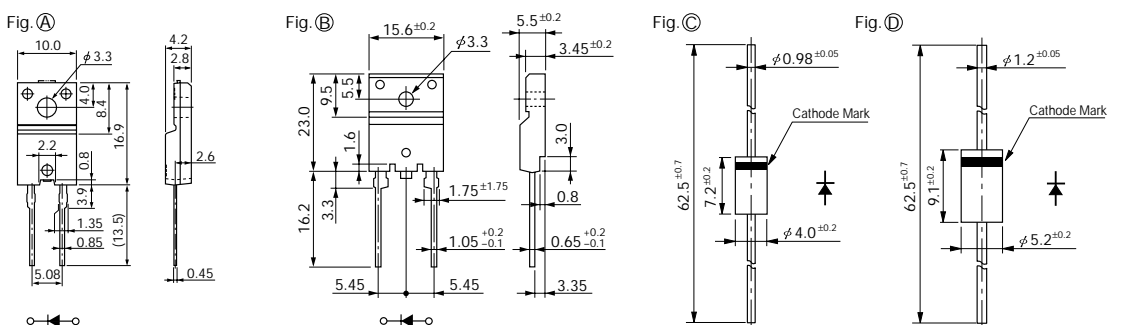

FMQ-G5FMS

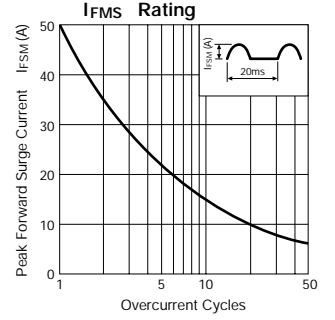
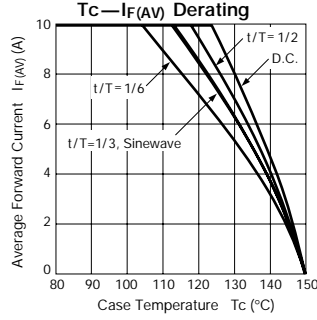
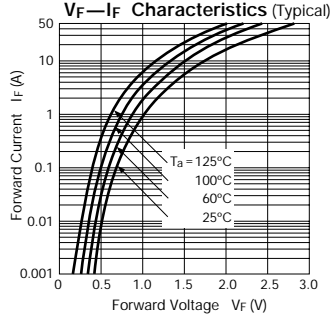
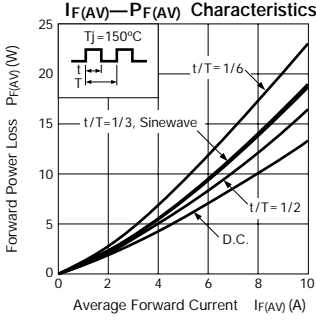

FMQ-G5GS

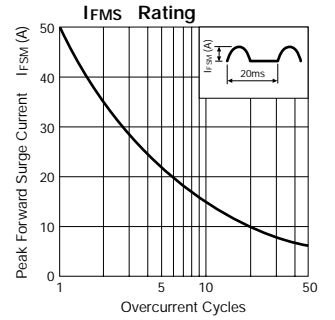
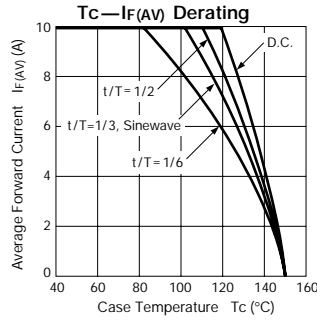
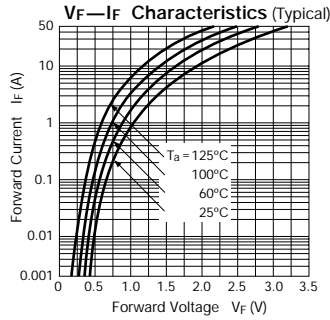
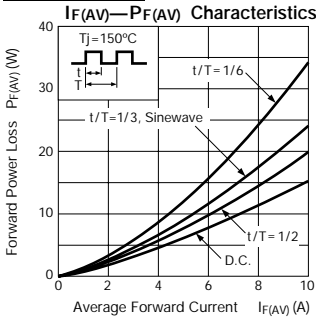

FMP-G5HS

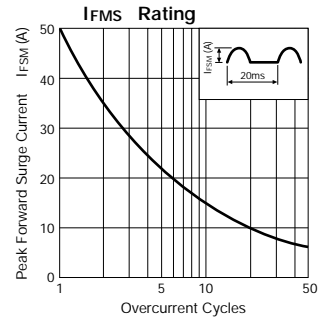
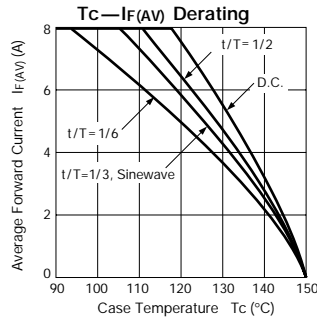
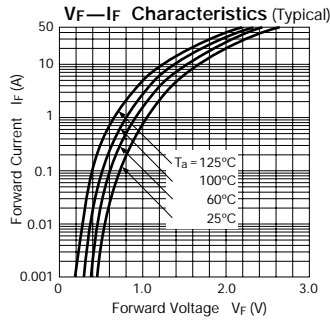
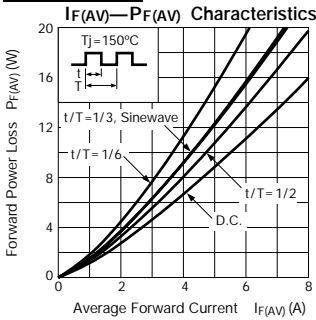

RG 2A2

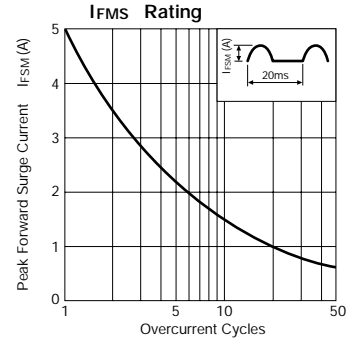
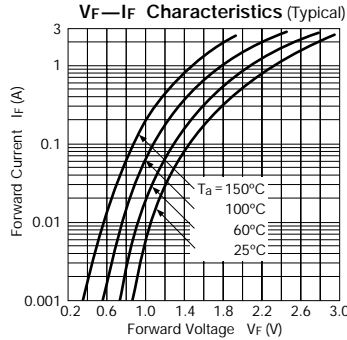
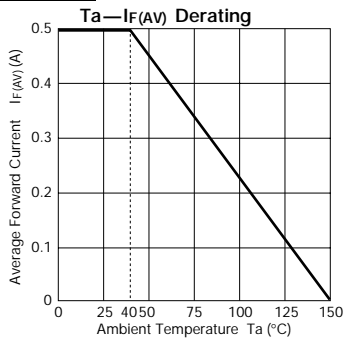

RC 3B2

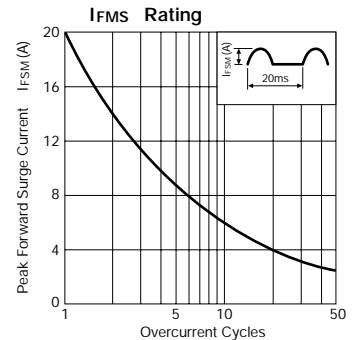
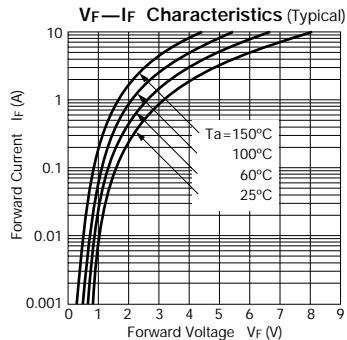
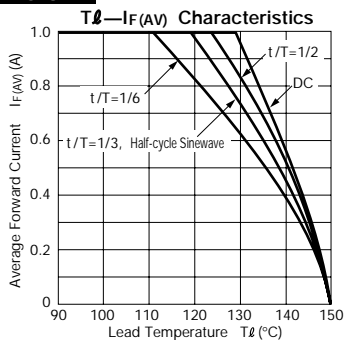

This datasheet has been downloaded from:

www.DatasheetCatalog.com

Datasheets for electronic components.



LittleDiode supplies new, hard to find or obsolete electronic components and semiconductors all over the world.

With over two million different components listed you are sure to find the part you need.

Feel free to visit us today at our online store:

LittleDiode.com

Looking forward to providing you with the best possible service.