

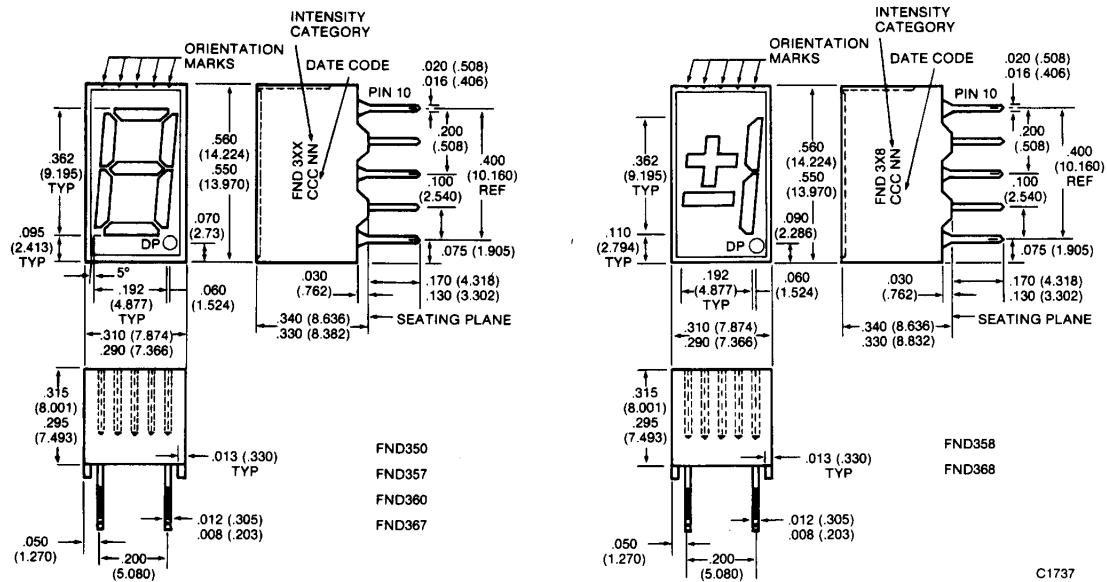

**0.362 - INCH  
7 - SEGMENT DISPLAY**

**HIGH EFFICIENCY RED FND310C FND317C FND318C**

**PACKAGE DIMENSIONS**



- NOTES:  
 1. ALL DIMENSIONS ARE IN MM (INCH)  
 2. TOLERANCE ARE  $\pm 0.010$  INCH UNLESS OTHERWISE SPECIFIED

**DESCRIPTION**

The FND310C, FND317C and FND318D are high efficiency red GaP 7-segment displays with nominal 0.362" digit height. Reflector cap, PCB and encapsulant are used in the construction of these FND3XXCs.

**FEATURES**

- Exactly pin and package compatible with FND3XX
- Compact — 10 digits in 3-inch panel width
- Wide viewing angle
- Right-hand decimal configuration
- Categorized for luminous intensity
- Rugged encapsulated plastic construction

MODEL NUMBERS		
PART NUMBER	COLOR	DESCRIPTION
FND310C	Hi. Eff. Red	Common anode seven segment display
FND317C	Hi. Eff. Red	Common cathode seven segment display
FND318C	Hi. Eff. Red	Common cathode $\pm 1$ overflow display

<b>ABSOLUTE MAXIMUM RATINGS</b>		
	<b>FND310C/317C</b>	<b>FND318C</b>
Power dissipation at 25°C ambient .....	500 mW	320 mW
Continuous forward current		
Total .....	200 mA	125 mA
Per segment or decimal point .....	25 mA	25 mA
Reverse voltage		
Per segment or decimal point .....	6 V	6 V
Storage and operating temperature .....	-25°C to +85°C	-25°C to +85°C
Soldering time at 250°C (1/16 inch from the seating plane) ...	3 sec	3 sec

<b>ELECTRO-OPTICAL CHARACTERISTICS (TA=25°C Unless Otherwise Specified)</b>					
<b>PARAMETER</b>	<b>MIN.</b>	<b>TYP.</b>	<b>MAX.</b>	<b>UNIT</b>	<b>TEST CONDITIONS</b>
Forward voltage - V (per diode)		2.0	2.5	V	I <sub>f</sub> =20 mA
Luminous intensity - I <sub>v</sub>	1800	2700		μcd	I <sub>f</sub> =20 mA
Peak wavelength		655		nm	I <sub>f</sub> =20 mA
Spectrum radiation bandwidth		45		nm	I <sub>f</sub> =20 mA
Reverse voltage-V <sub>r</sub>	5			V	I <sub>r</sub> =100 μA
Capacitance - C		35		pF	V=0, F=1 MHz

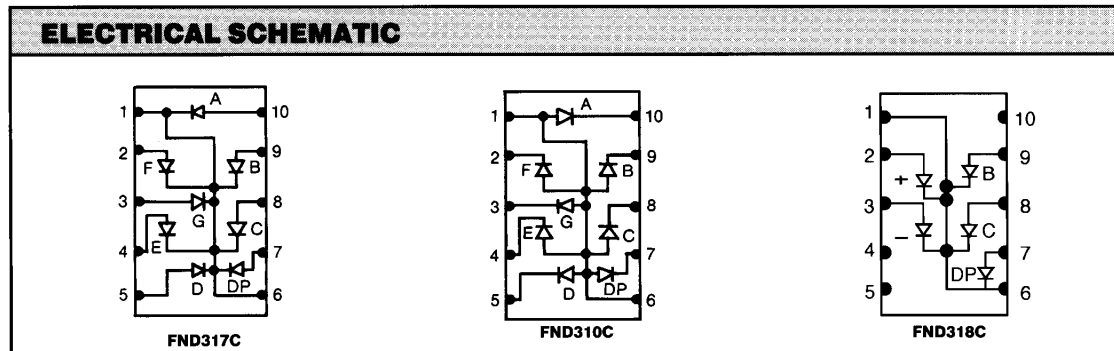
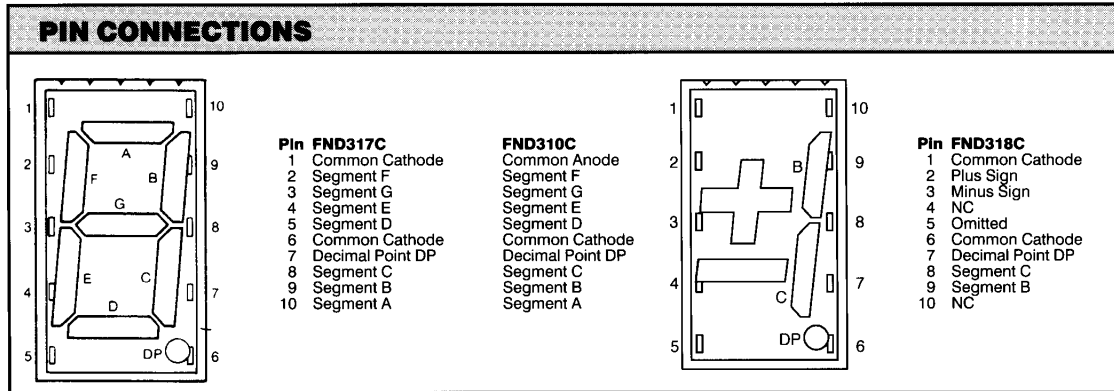

**TYPICAL ELECTRO - OPTICAL CHARACTERISTIC CURVES**

( $T_A=25^\circ\text{C}$  Unless otherwise specified)

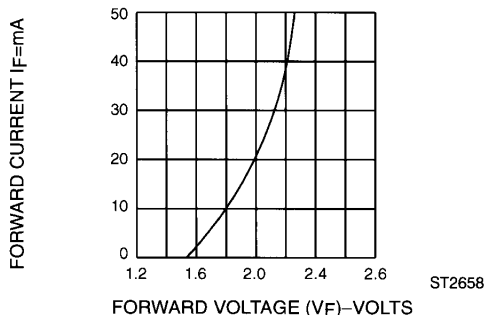

Fig. 1 Forward Current vs. Forward Voltage

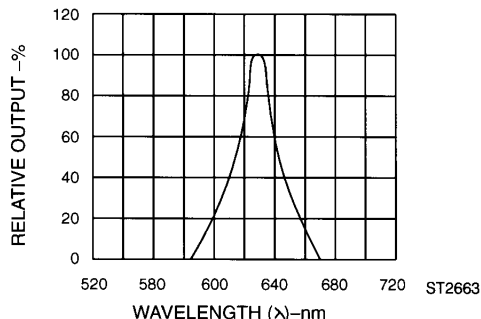

Fig. 2. Spectral Response

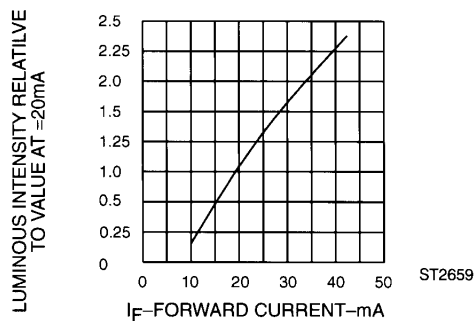

Fig. 3 Relative Luminous Intensity vs. Forward Current

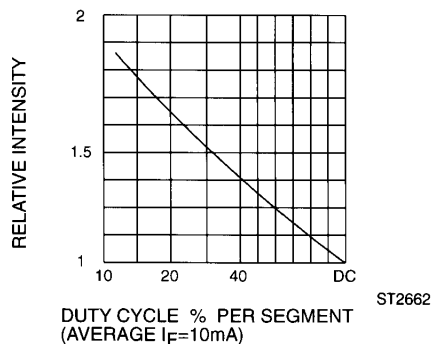

Fig. 5 Luminous Intensity vs. Duty Cycle

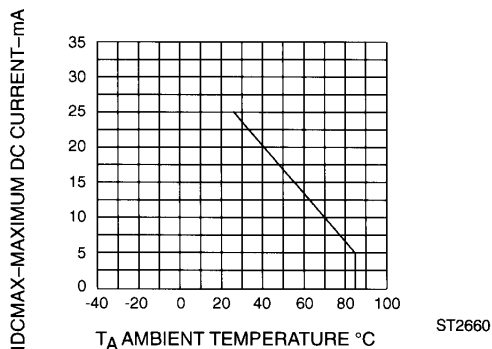

Fig. 4 Maximum Allowable DC Current Per Segment vs. a Function of Ambient Temperature

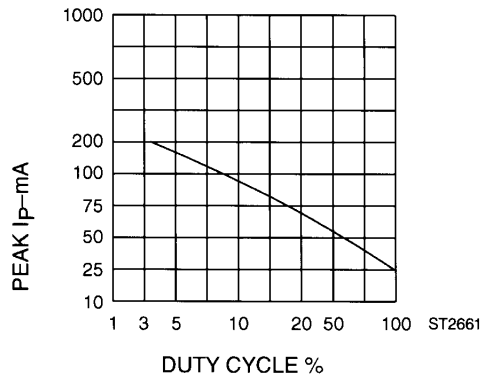

Fig. 6 Max Peak Current vs. Duty Cycle % (Refresh Rate f=1.KHz)

Clean the displays only in water, isopropanol, ethanol, freon TF or TE (or equivalent)



LittleDiode supplies new, hard to find or obsolete electronic components and semiconductors all over the world.

With over two million different components listed you are sure to find the part you need.

Feel free to visit us today at our online store:

**[LittleDiode.com](http://LittleDiode.com)**

Looking forward to providing you with the best possible service.