

**Features**

- 24A, 600V
- Latch Free Operation
- Typical Fall Time <500ns
- High Input Impedance
- Low Conduction Loss

**Description**

The IGBT is a MOS gated high voltage switching device combining the best features of MOSFETs and bipolar transistors. The device has the high input impedance of a MOSFET and the low on-state conduction loss of a bipolar transistor. The much lower on-state voltage drop varies only moderately between +25°C and +150°C.

IGBTs are ideal for many high voltage switching applications operating at moderate frequencies where low conduction losses are essential, such as: AC and DC motor controls, power supplies and drivers for solenoids, relays and contactors.

**PACKAGING AVAILABILITY**

PART NUMBER	PACKAGE	BRAND
HGTG24N60D1	TO-247	G24N60D1

**Package**

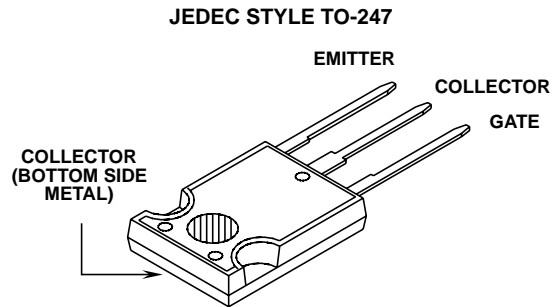

**Terminal Diagram**

**N-CHANNEL ENHANCEMENT MODE**

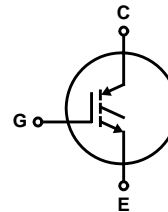

**Absolute Maximum Ratings**  $T_C = +25^\circ\text{C}$ , Unless Otherwise Specific

	HGTG24N60D1	UNITS
Collector-Emitter Voltage	600	V
Collector-Gate Voltage $R_{GE} = 1\text{M}\Omega$	600	V
Collector Current Continuous at $T_C = +25^\circ\text{C}$	40	A
at $V_{GE} = 15\text{V}$ at $T_C = +90^\circ\text{C}$	24	A
Collector Current Pulsed (Note 1)	96	A
Gate-Emitter Voltage Continuous	$\pm 25$	V
Switching Safe Operating Area at $T_J = +150^\circ\text{C}$	60A at 0.8 $BV_{CES}$	-
Power Dissipation Total at $T_C = +25^\circ\text{C}$	125	W
Power Dissipation Derating $T_C > +25^\circ\text{C}$	1.0	W/ $^\circ\text{C}$
Operating and Storage Junction Temperature Range	-55 to +150	$^\circ\text{C}$
Maximum Lead Temperature for Soldering (0.125 inch from case for 5s)	260	$^\circ\text{C}$

**NOTE:**

1. Repetitive Rating: Pulse width limited by maximum junction temperature.

**INTERSIL CORPORATION IGBT PRODUCT IS COVERED BY ONE OR MORE OF THE FOLLOWING U.S. PATENTS:**

4,364,073	4,417,385	4,430,792	4,443,931	4,466,176	4,516,143	4,532,534	4,567,641
4,587,713	4,598,461	4,605,948	4,618,872	4,620,211	4,631,564	4,639,754	4,639,762
4,641,162	4,644,637	4,682,195	4,684,413	4,694,313	4,717,679	4,743,952	4,783,690
4,794,432	4,801,986	4,803,533	4,809,045	4,809,047	4,810,665	4,823,176	4,837,606
4,860,080	4,883,767	4,888,627	4,890,143	4,901,127	4,904,609	4,933,740	4,963,951
4,969,027							

# Specifications HGTG24N60D1

## Electrical Specifications $T_C = +25^\circ\text{C}$ , Unless Otherwise Specified

PARAMETERS	SYMBOL	TEST CONDITIONS	LIMITS			UNITS	
			MIN	TYP	MAX		
Collector-Emitter Breakdown Voltage	$BV_{CES}$	$I_C = 250\mu\text{A}$ , $V_{GE} = 0\text{V}$	600	-	-	V	
Collector-Emitter Leakage Voltage	$I_{CES}$	$V_{CE} = BV_{CES}$ , $T_C = +25^\circ\text{C}$	-	-	1.0	mA	
		$V_{CE} = 0.8 BV_{CES}$ , $T_C = +125^\circ\text{C}$	-	-	4.0	mA	
Collector-Emitter Saturation Voltage	$V_{CE(SAT)}$	$I_C = I_{C90}$ , $V_{GE} = 15\text{V}$	$T_C = +25^\circ\text{C}$	-	1.7	2.3	V
			$T_C = +125^\circ\text{C}$	-	1.9	2.5	V
Gate-Emitter Threshold Voltage	$V_{GE(TH)}$	$I_C = 250\mu\text{A}$ , $V_{CE} = V_{GE}$	3.0	4.5	6.0	V	
Gate-Emitter Leakage Current	$I_{GES}$	$V_{GE} = \pm 20\text{V}$	-	-	$\pm 500$	nA	
Gate-Emitter Plateau Voltage	$V_{GEP}$	$I_C = I_{C90}$ , $V_{CE} = 0.5 BV_{CES}$	-	6.3	-	V	
On-State Gate Charge	$Q_{G(ON)}$	$I_C = I_{C90}$ , $V_{CE} = 0.5 BV_{CES}$	$V_{GE} = 15\text{V}$	-	120	155	nC
			$V_{GE} = 20\text{V}$	-	155	200	nC
Current Turn-On Delay Time	$t_{D(ON)I}$	$L = 500\mu\text{H}$ , $I_C = I_{C90}$ , $R_G = 25\Omega$ , $V_{GE} = 15\text{V}$ , $T_J = +150^\circ\text{C}$ , $V_{CE} = 0.8 BV_{CES}$	-	100	-	ns	
Current Rise Time	$t_{RI}$		-	150	-	ns	
Current Turn-Off Delay Time	$t_{D(OFF)I}$		-	700	900	ns	
Current Fall Time	$t_{FI}$		-	450	600	ns	
Turn-Off Energy (Note 1)	$W_{OFF}$		-	4.3	-	mJ	
Thermal Resistance	$R_{\theta JC}$		-	-	1.00	$^\circ\text{C}/\text{W}$	

NOTE: 1. Turn-Off Energy Loss ( $W_{OFF}$ ) is defined as the integral of the instantaneous power loss starting at the trailing edge of the input pulse and ending at the point where the collector current equals zero ( $I_{CE} = 0\text{A}$ ). The HGTG24N60D1 was tested per JEDEC standard No. 24-1 Method for Measurement of Power Device Turn-Off Switching Loss. This test method produces the true total Turn-Off Energy Loss.

## Typical Performance Curves

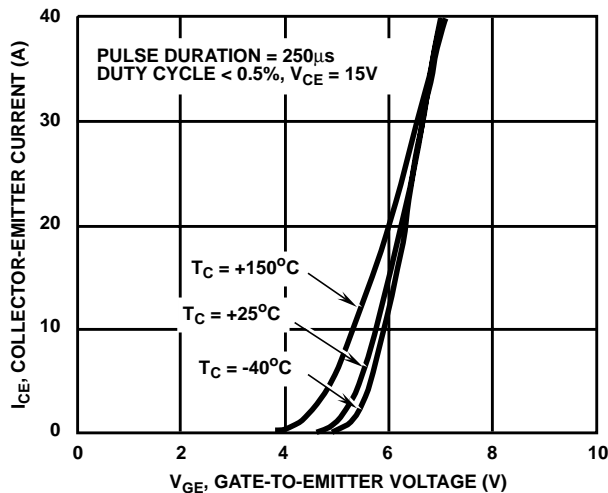

FIGURE 1. TRANSFER CHARACTERISTICS (TYPICAL)

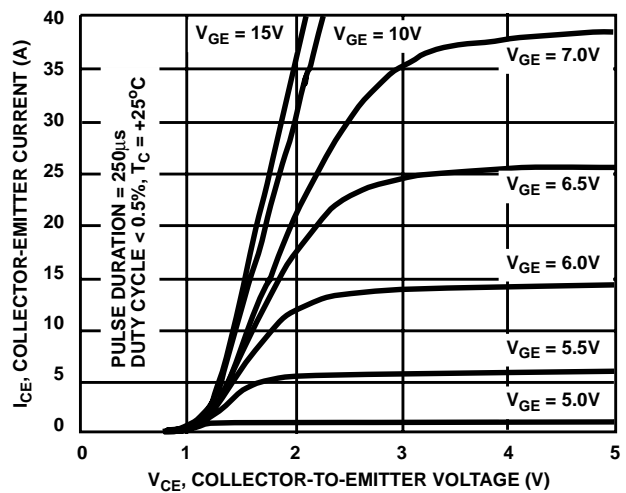

FIGURE 2. SATURATION CHARACTERISTICS (TYPICAL)

Typical Performance Curves (Continued)

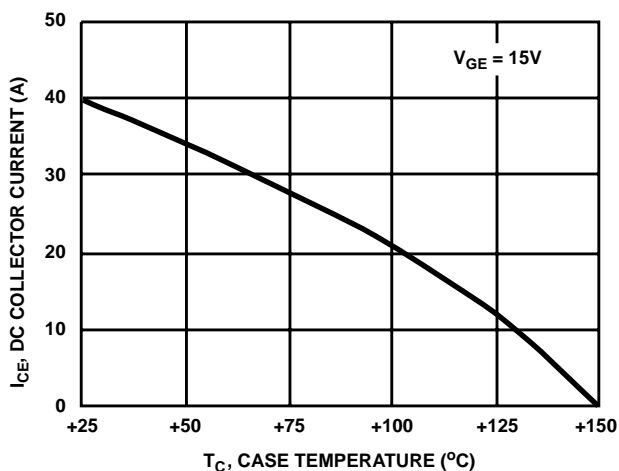

FIGURE 3. DC COLLECTOR CURRENT vs CASE TEMPERATURE

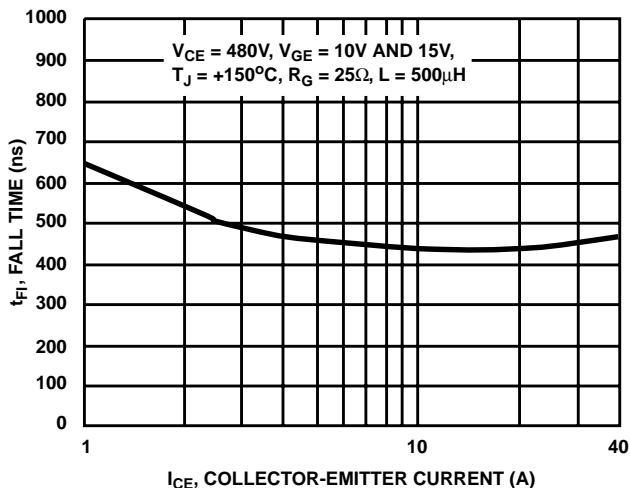

FIGURE 4. FALL TIME vs COLLECTOR-EMITTER CURRENT

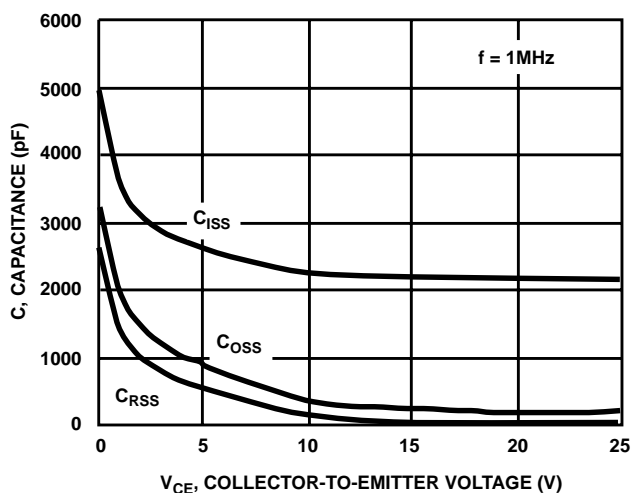

FIGURE 5. CAPACITANCE vs COLLECTOR-EMITTER VOLTAGE

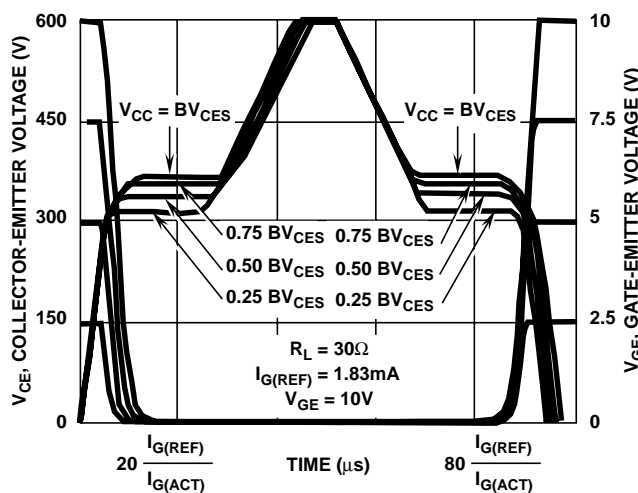

FIGURE 6. NORMALIZED SWITCHING WAVEFORMS AT CONSTANT GATE CURRENT (REFER TO APPLICATION NOTES AN7254 AND AN7260)

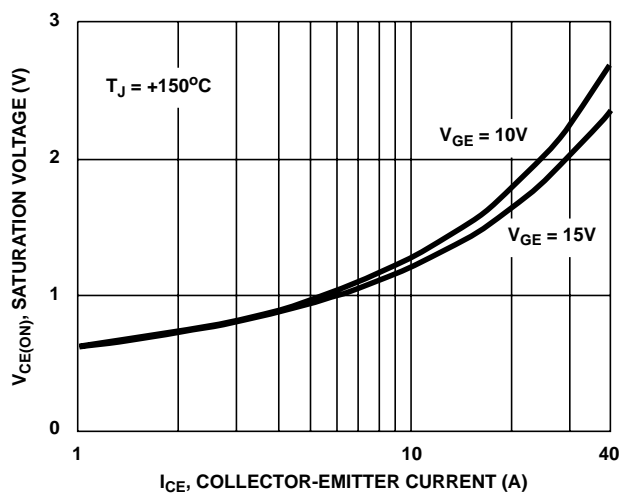

FIGURE 7. SATURATION VOLTAGE vs COLLECTOR-EMITTER CURRENT

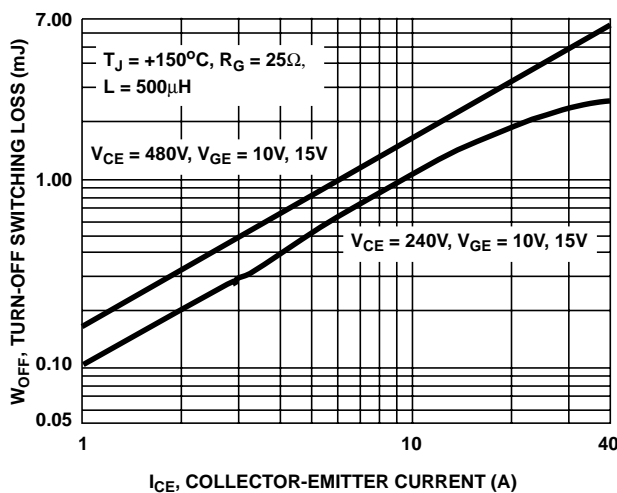

FIGURE 8. TURN-OFF SWITCHING LOSS vs COLLECTOR-EMITTER CURRENT

Typical Performance Curves (Continued)

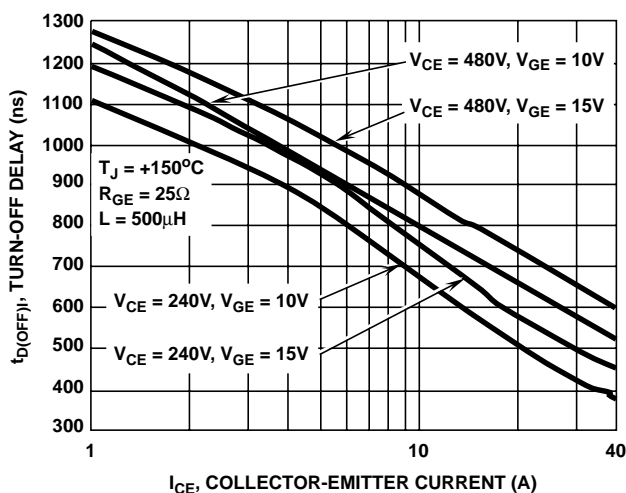
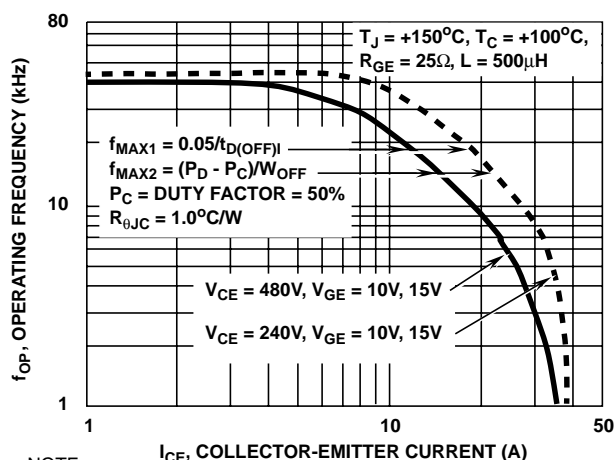

FIGURE 9. TURN-OFF DELAY vs COLLECTOR-EMITTER CURRENT



NOTE:  $P_D$  = ALLOWABLE DISSIPATION  $P_C$  = CONDUCTION DISSIPATION

FIGURE 10. OPERATING FREQUENCY vs COLLECTOR-EMITTER CURRENT AND VOLTAGE

Operating Frequency Information

Operating frequency information for a typical device (Figure 10) is presented as a guide for estimating device performance for a specific application. Other typical frequency vs collector current ( $I_{CE}$ ) plots are possible using the information shown for a typical unit in Figures 7, 8 and 9. The operating frequency plot (Figure 10) of a typical device shows  $f_{MAX1}$  or  $f_{MAX2}$  whichever is smaller at each point. The information is based on measurements of a typical device and is bounded by the maximum rated junction temperature.

$f_{MAX1}$  is defined by  $f_{MAX1} = 0.05/t_{D(OFF)|}$ .  $t_{D(OFF)|}$  deadtime (the denominator) has been arbitrarily held to 10% of the on-state time for a 50% duty factor. Other definitions are possible.  $t_{D(OFF)|}$  is defined as the time between the 90% point of the trailing edge of the input pulse and the point where the collector current falls to 90% of its maximum value. Device

turn-off delay can establish an additional frequency limiting condition for an application other than  $T_{JMAX}$ .  $t_{D(OFF)|}$  is important when controlling output ripple under a lightly loaded condition.

$f_{MAX2}$  is defined by  $f_{MAX2} = (P_D - P_C)/W_{OFF}$ . The allowable dissipation ( $P_D$ ) is defined by  $P_D = (T_{JMAX} - T_C)/R_{\theta JC}$ . The sum of device switching and conduction losses must not exceed  $P_D$ . A 50% duty factor was used (Figure 10) and the conduction losses ( $P_C$ ) are approximated by  $P_C = (V_{CE} \cdot I_{CE})/2$ .  $W_{OFF}$  is defined as the integral of the instantaneous power loss starting at the trailing edge of the input pulse and ending at the point where the collector current equals zero ( $I_{CE} = 0A$ ).

The switching power loss (Figure 10) is defined as  $f_{MAX2} \cdot W_{OFF}$ . Turn-on switching losses are not included because they can be greatly influenced by external circuit conditions and components.

All Intersil semiconductor products are manufactured, assembled and tested under ISO9000 quality systems certification.

Intersil products are sold by description only. Intersil Corporation reserves the right to make changes in circuit design and/or specifications at any time without notice. Accordingly, the reader is cautioned to verify that data sheets are current before placing orders. Information furnished by Intersil is believed to be accurate and reliable. However, no responsibility is assumed by Intersil or its subsidiaries for its use; nor for any infringements of patents or other rights of third parties which may result from its use. No license is granted by implication or otherwise under any patent or patent rights of Intersil or its subsidiaries.

For information regarding Intersil Corporation and its products, see web site <http://www.intersil.com>

Sales Office Headquarters

**NORTH AMERICA**  
Intersil Corporation  
P. O. Box 883, Mail Stop 53-204  
Melbourne, FL 32902  
TEL: (407) 724-7000  
FAX: (407) 724-7240

**EUROPE**  
Intersil SA  
Mercure Center  
100, Rue de la Fusee  
1130 Brussels, Belgium  
TEL: (32) 2.724.2111  
FAX: (32) 2.724.22.05

**ASIA**  
Intersil (Taiwan) Ltd.  
Taiwan Limited  
7F-6, No. 101 Fu Hsing North Road  
Taipei, Taiwan  
Republic of China  
TEL: (886) 2 2716 9310  
FAX: (886) 2 2715 3029

This datasheet has been downloaded from:

[www.DatasheetCatalog.com](http://www.DatasheetCatalog.com)

Datasheets for electronic components.



LittleDiode supplies new, hard to find or obsolete electronic components and semiconductors all over the world.

With over two million different components listed you are sure to find the part you need.

Feel free to visit us today at our online store:

[LittleDiode.com](http://LittleDiode.com)

Looking forward to providing you with the best possible service.