

# Surface Mount Chip LEDs

## Technical Data

**HSMX-C650**  
**HSMX-C670**  
**HSMF-C655**

### Features

- **Small Size**
- **Industry Standard Footprint**
- **Low Profile**
- **Tinted, Diffused Optics**
- **Compatible with IR Solder Process**
- **Five Colors and Bicolor Available**
- **Available in 8 mm Tape on 7" (178 mm) Diameter Reels**

### Applications

- **Push-Button Backlighting**
- **LCD Backlighting**
- **Symbol Backlighting**
- **Front Panel Indicator**

### Description

These single and bicolor LEDs are designed in an industry standard package for ease of handling and use. Five different LED colors are available in two compact, low profile, single color packages. The 3.2 x 1.6 mm is an excellent all around package, and the small 2.0 x 1.25 mm package is designed for applications where space is limited. The single color LEDs have

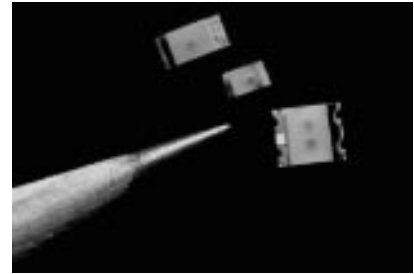

tinted diffused optics. The bicolor package is untinted, diffused.

The small size, low 1.1 mm profile and wide viewing angle make these LEDs excellent for backlighting applications and front panel illumination. They are compatible with IR reflow soldering processes.

### Device Selection Guide

Footprint (mm)	DH AlGaAs Red	High Efficiency Red	Orange	Yellow	Green	Bicolor HER-Green
3.20 x 1.60	HSMH-C650	HSMS-C650	HSMD-C650	HSMY-C650	HSMG-C650	
2.00 x 1.25	HSMH-C670	HSMS-C670	HSMD-C670	HSMY-C670	HSMG-C670	
3.20 x 2.70						HSMF-C655

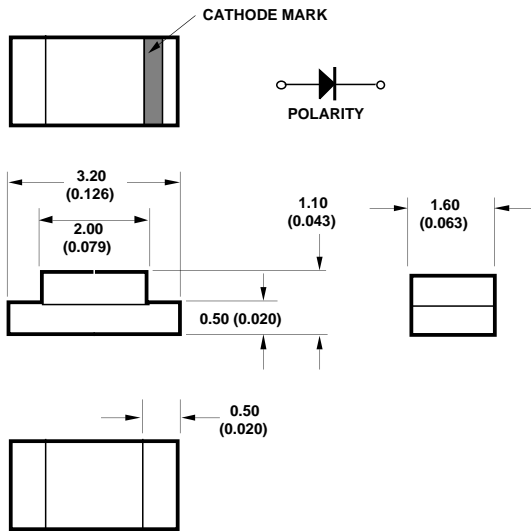

**HSMX-C650 Series**

[1206]

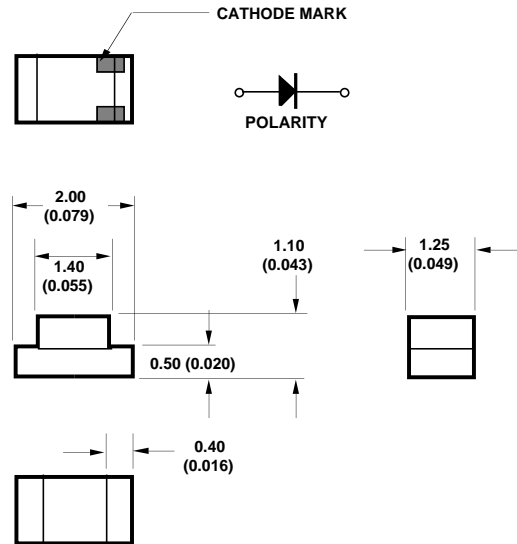

**HSMX-C670 Series**

[805]

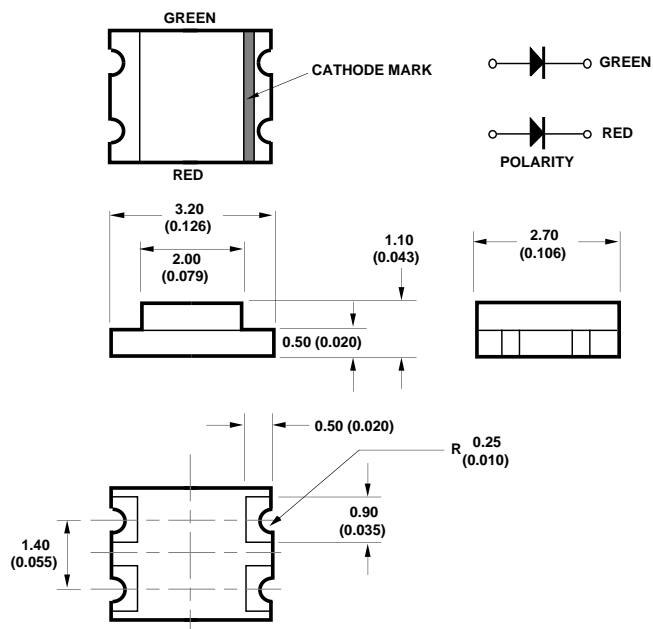

**HSMF-C655**

[1210]

### Absolute Maximum Ratings at $T_A = 25^\circ\text{C}$

Parameter	HSMX-C650 HSMF-C655	HSMX-C670	Units
DC Forward Current <sup>[1]</sup>	25	20	mA
Power Dissipation	65	50	mW
Reverse Voltage ( $I_R = 100 \mu\text{A}$ )	5	5	V
LED Junction Temperature	95	95	$^\circ\text{C}$
Operating Temperature Range	-25 to +80	-25 to +80	$^\circ\text{C}$
Storage Temperature Range	-30 to +85	-30 to +85	$^\circ\text{C}$
Soldering Temperature	See SMT reflow soldering profile, Figure 6		

**Notes:**

- Derate linearly as shown in Figure 4 for temperatures above  $25^\circ\text{C}$ .

### Optical Characteristics at $T_A = 25^\circ\text{C}$

Part Number	Color	Luminous Intensity $I_V$ (mcd) @ $I_F$ 20 mA <sup>[1]</sup>		Peak Wavelength $\lambda_{\text{peak}}$ (nm) Typ.	Color, Dominant Wavelength $\lambda_d$ <sup>[2]</sup> (nm) Typ.	Viewing Angle $2\theta_{1/2}$ Degrees <sup>[3]</sup> Typ.
		Min.	Typ.			
HSMH-C650 HSMH-C670	DH AlGaAs Red	6.3	16.0	650	639	155
HSMS-C650 HSMS-C670	High Efficiency Red	1.6	5.0	639	626	155
HSMC-C650 HSMC-C670	Orange	1.6	4.0	606	604	155
HSMY-C650 HSMY-C670	Yellow	1.6	5.0	584	586	155
HSMG-C650 HSMG-C670	Green	4.0	9.0	566	571	155
HSMF-C655	High Efficiency Red	1.6	5.0	639	626	155
	Green	4.0	9.0	566	571	155

**Notes:**

- The luminous intensity,  $I_V$ , is measured at the peak of the spatial radiation pattern which may not be aligned with the mechanical axis of the lamp package.
- The dominant wavelength,  $\lambda_d$ , is derived from the CIE Chromaticity Diagram and represents the perceived color of the device.
- $\theta_{1/2}$  is the off-axis angle where the luminous intensity is 1/2 the peak intensity.
- Chip LEDs are supplied in 8 mm embossed tape on 178 mm (7 in.) diameter reels, with 3000 devices per reel. Minimum order quantity and order increments are in quantity of reels only.

### Electrical Characteristics at $T_A = 25^\circ\text{C}$

Part Number	Color	Forward Voltage $V_F$ (Volts) @ $I_F = 20\text{ mA}$		Reverse Breakdown $V_R$ (Volts) @ $I_R = 100\ \mu\text{A}$ Min.	Capacitance $C$ (pF) $V_F = 0$ , $f = 1\text{ MHz}$ Typ.	Thermal Resistance $R\theta_{J-PIN}$ ( $^\circ\text{C/W}$ )
		Typ.	Max.			
HSMH-C650 HSMH-C670	DH AlGaAs Red	1.8	2.2	5	46	460 300
HSMS-C650 HSMS-C670	High Efficiency Red	1.9	2.6	5	4.0	400 250
HSMD-C650 HSMD-C670	Orange	2.1	2.6	5	4.0	400 250
HSMY-C650 HSMY-C670	Yellow	2.1	2.6	5	3.0	400 250
HSMG-C650 HSMG-C670	Green	2.2	3.0	5	8.0	400 250
HSMF-C655	High Efficiency Red	1.9	2.6	5	3.7	325
	Green	2.2	3.0	5	6.3	325

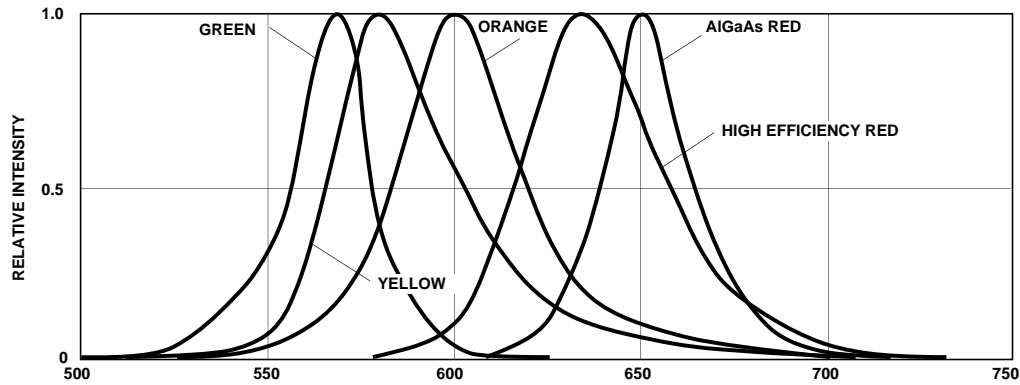

Figure 1. Relative Intensity vs. Wavelength.

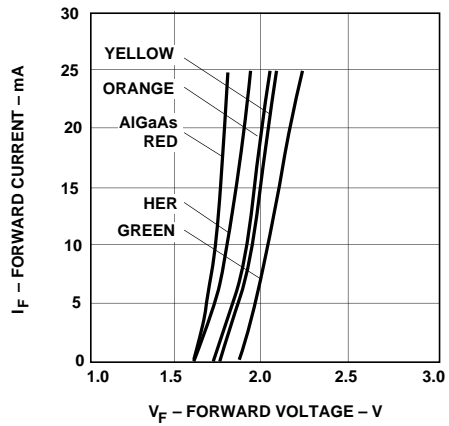

Figure 2. Forward Current vs. Forward Voltage.

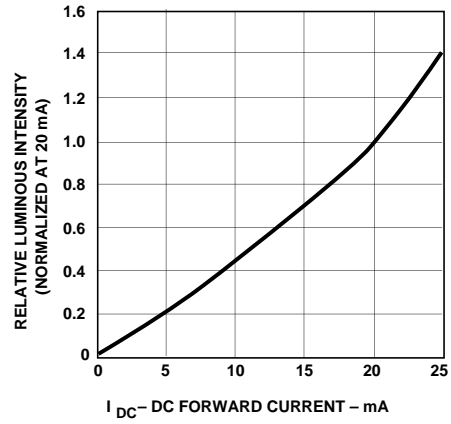

Figure 3. Relative Luminous Intensity vs. DC Forward Current.

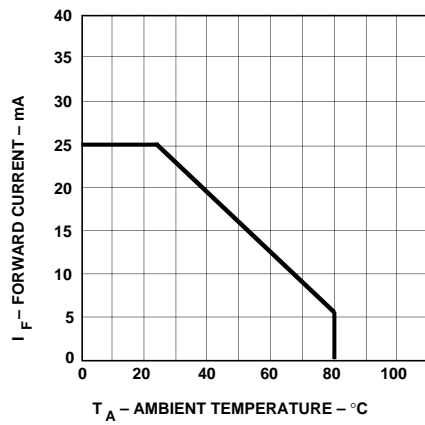

Figure 4. Maximum DC Current vs. Ambient Temperature.

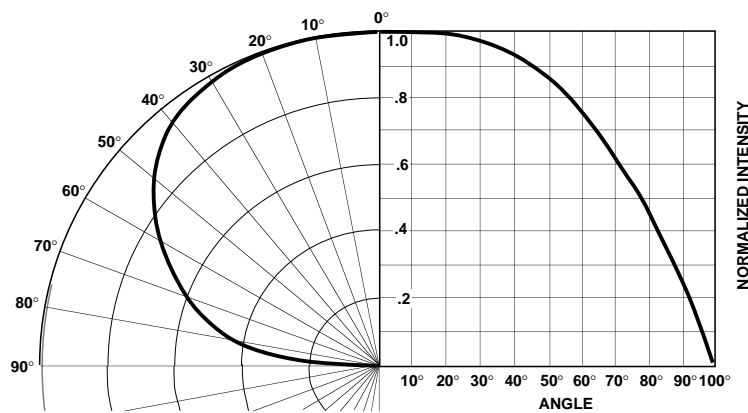
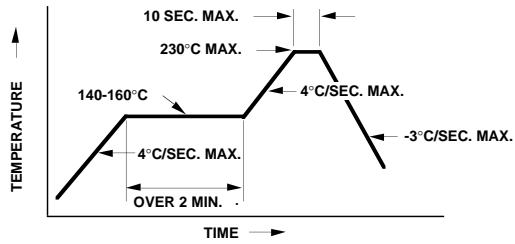
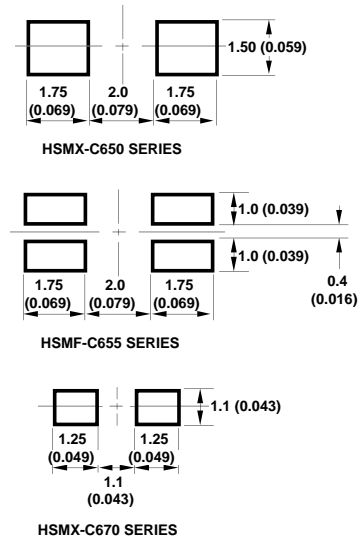

Figure 5. Intensity vs. Angle.



**Figure 6. Recommended SMT Reflow Soldering Profile.**



**Figure 7. Recommended Solder Patterns.**

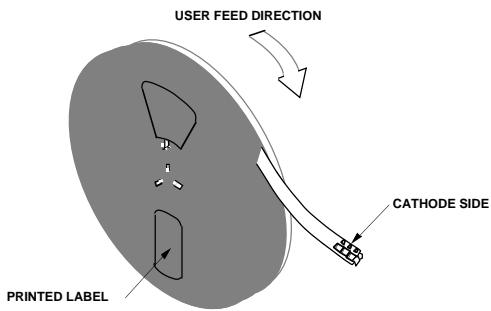

**Figure 8. Reeling Orientation.**

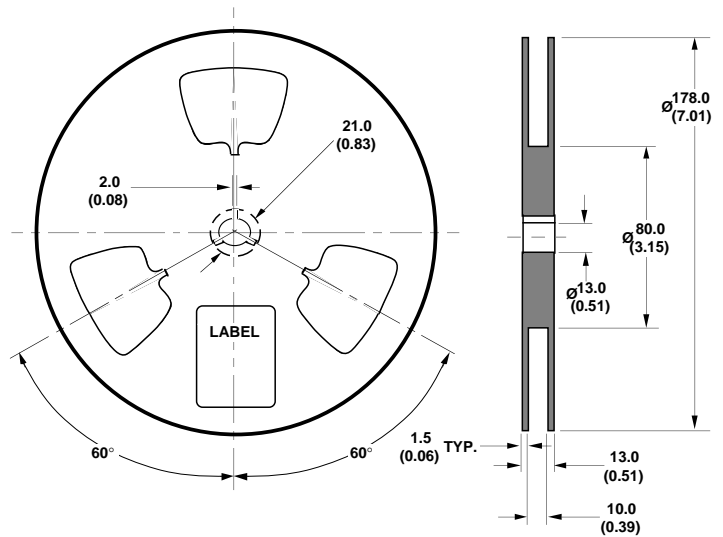

**Figure 9. Reel Dimensions.**

NOTE:  
ALL DIMENSIONS IN MILLIMETERS (INCHES).

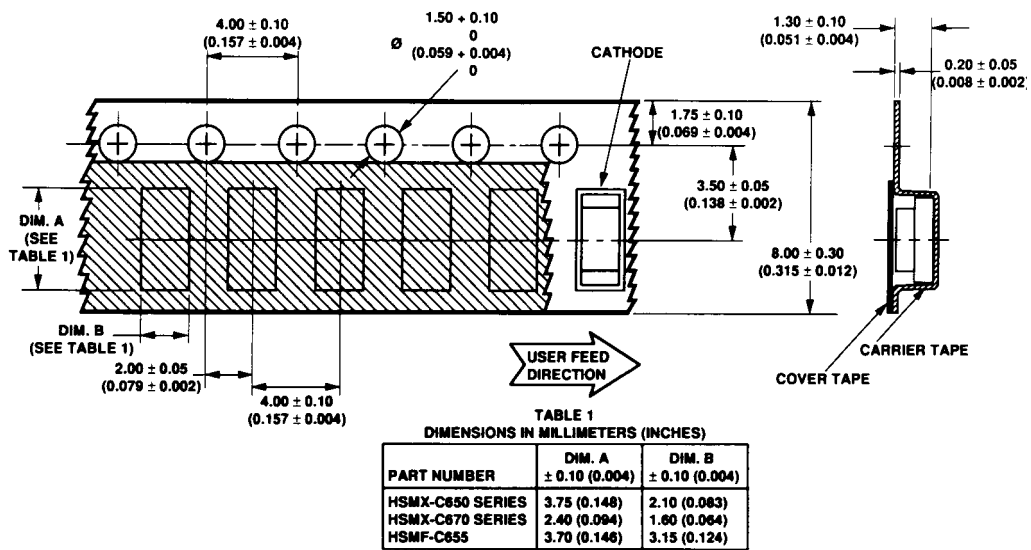

Figure 10. Tape Dimensions.

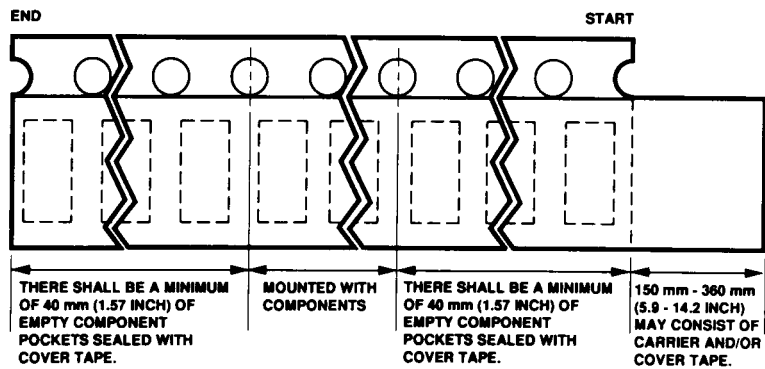

Figure 11. Tape Leader and Trailer Dimensions.



LittleDiode supplies new, hard to find or obsolete electronic components and semiconductors all over the world.

With over two million different components listed you are sure to find the part you need.

Feel free to visit us today at our online store:

[LittleDiode.com](http://LittleDiode.com)

Looking forward to providing you with the best possible service.