

Optocoupler, Phototransistor Output, AC Input, With Base Connection

Features

- Guaranteed CTR Symmetry, 2:1 Maximum
- Bidirectional AC Input Industry Standard SOIC-8 Surface Mountable Package
- Standard Lead Spacing, .05 "
- Available only on Tape and Reel (Conform to EIA Standard RS481A)

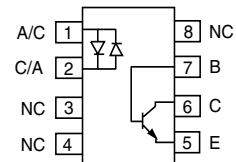
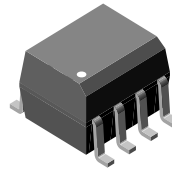

Agency Approvals

- UL File #E52744 System Code Y
- CSA 93751
- DIN EN 60747-5-2(VDE0884)
DIN EN 60747-5-5 pending
Available with Option 1
- FIMKO

1179025

The product is well suited for telecom applications such as ring detection or off/on hook status, given its bidirectional LED input and guaranteed current transfer ratio (CTR) minimum of 20 % at $I_F = 10 \text{ mA}$.

Applications

Telecom applications ring detection

Description

The IL256A is an AC input phototransistor optocoupler. The device consists of two infrared emitters connected in reverse parallel and coupled to a silicon NPN phototransistor detector.

These circuit elements are constructed with a standard SOIC-8 foot print.

Order Information

Part	Remarks
IL256AT	CTR > 20 %, Tape and reel, SOIC-8

For additional information on the available options refer to Option Information.

Absolute Maximum Ratings

$T_{amb} = 25 \text{ }^\circ\text{C}$, unless otherwise specified

Stresses in excess of the absolute Maximum Ratings can cause permanent damage to the device. Functional operation of the device is not implied at these or any other conditions in excess of those given in the operational sections of this document. Exposure to absolute Maximum Rating for extended periods of the time can adversely affect reliability.

Input

Parameter	Test condition	Symbol	Value	Unit
Forward continuous current		I_F	60	mA
Power dissipation		P_{diss}	90	mW
Derate linearly from 25 °C			0.8	mW/°C

Output

Parameter	Test condition	Symbol	Value	Unit
Collector-emitter breakdown voltage		BV_{CEO}	30	V
Emitter-collector breakdown voltage		BV_{ECO}	5.0	V
Collector-base breakdown voltage		BV_{CBO}	70	V
Power dissipation		P_{diss}	150	mW
Derate linearly from 25 °C			2.0	mW/°C

Coupler

Parameter	Test condition	Symbol	Value	Unit
Total package dissipation (LED + detector)		P_{tot}	240	mW
Derate linearly from 25 °C			3.2	mW/°C
Storage temperature		T_{stg}	- 55 to + 150	°C
Operating temperature		T_{amb}	- 55 to + 100	°C
Soldering time at 260 °C			10	sec.

Electrical Characteristics

$T_{amb} = 25\text{ °C}$, unless otherwise specified

Minimum and maximum values are testing requirements. Typical values are characteristics of the device and are the result of engineering evaluation. Typical values are for information only and are not part of the testing requirements.

Input

Parameter	Test condition	Symbol	Min	Typ.	Max	Unit
Forward voltage	$I_F = \pm 10\text{ mA}$	V_F		1.2	1.5	V

Output

Parameter	Test condition	Symbol	Min	Typ.	Max	Unit
Collector-emitter breakdown voltage	$I_C = 1.0\text{ mA}$	BV_{CEO}	30	50		V
Emitter-collector breakdown voltage	$I_E = 100\text{ }\mu\text{A}$	BV_{ECO}	5.0	10		V
Collector-base breakdown voltage	$I_C = 100\text{ }\mu\text{A}$	BV_{CBO}	70	90		V
Collector-emitter leakage current	$V_{CE} = 10\text{ V}$	I_{CEO}		5.0	50	nA

Coupler

Parameter	Test condition	Symbol	Min	Typ.	Max	Unit
Saturation voltage, collector-emitter	$I_F = \pm 16\text{ mA}$, $I_C = 2.0\text{ mA}$	V_{CEsat}			0.4	V
Isolation voltage, input to output		V_{ISO}	3000			V_{RMS}

Current Transfer Ratio

Parameter	Test condition	Symbol	Min	Typ.	Max	Unit
DC Current Transfer Ratio	$I_F = \pm 10\text{ mA}$, $V_{CE} = 5.0\text{ V}$	CTR_{DC}	20			%
Symmetry (CTR at + 10 mA)/ (CTR at -10 mA)			0.5	1.0	2.0	

Typical Characteristics ($T_{amb} = 25\text{ }^{\circ}\text{C}$ unless otherwise specified)

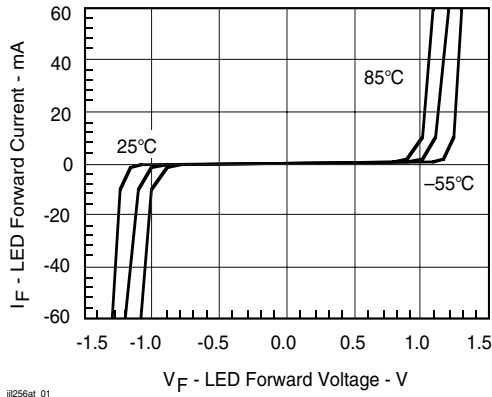

Fig. 1 LED Forward Current vs. Forward Voltage

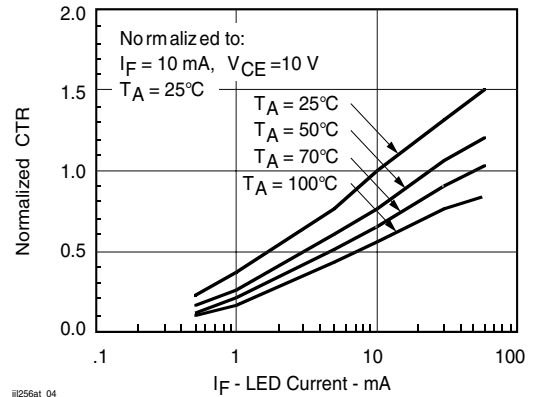

Fig. 4 Normalized CTR vs. I_F and T_{amb}

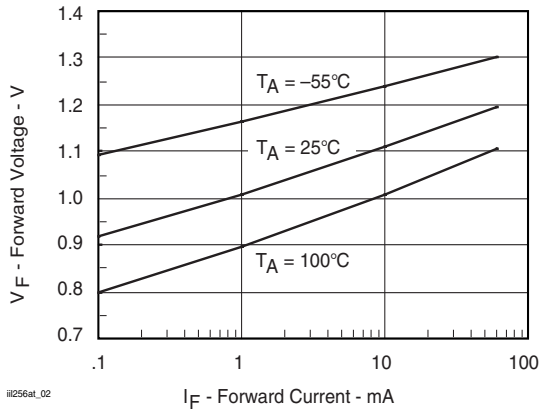

Fig. 2 Forward Voltage vs. Forward Current

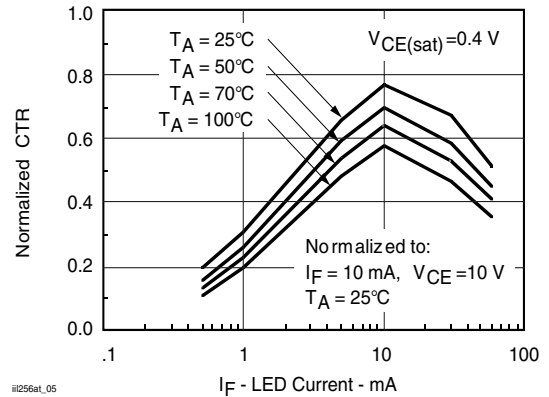

Fig. 5 Normalized Saturated CTR

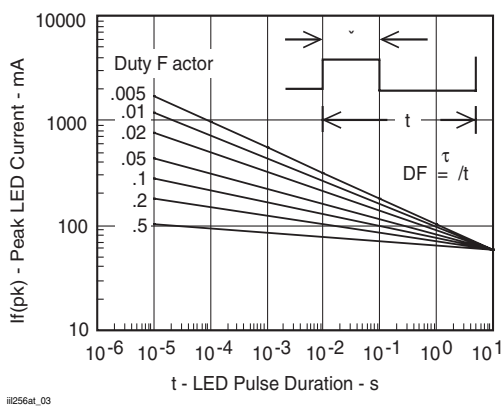

Fig. 3 Peak LED Current vs. Duty Factor, τ

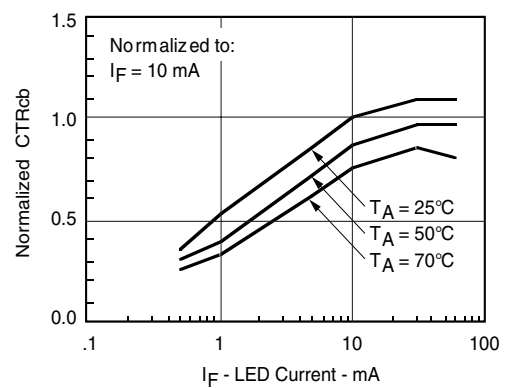
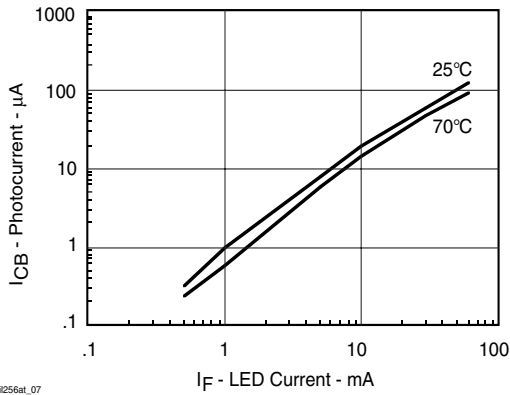
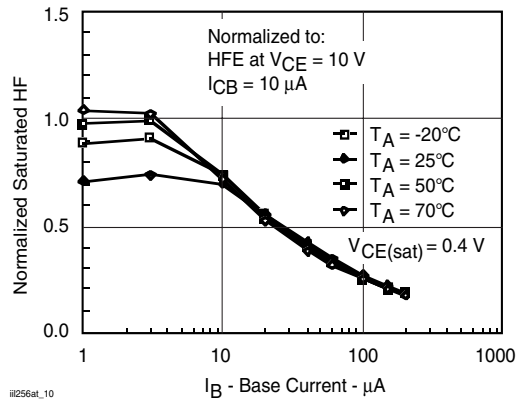

Fig. 6 Normalized CTR_{cb}



il256at_07

Fig. 7 Photocurrent vs. LED Current



il256at_10

Fig. 10 Normalized Saturated HFE vs. Base Current

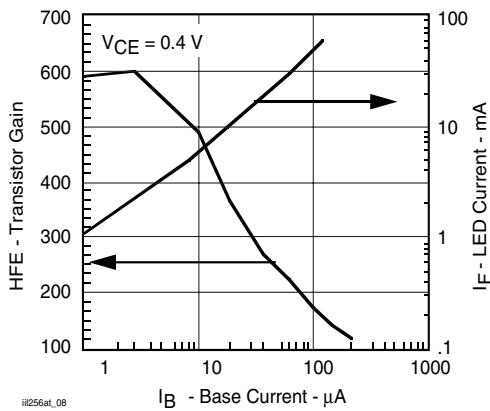

il256at_08

Fig. 8 Base Current vs. I_F and HFE

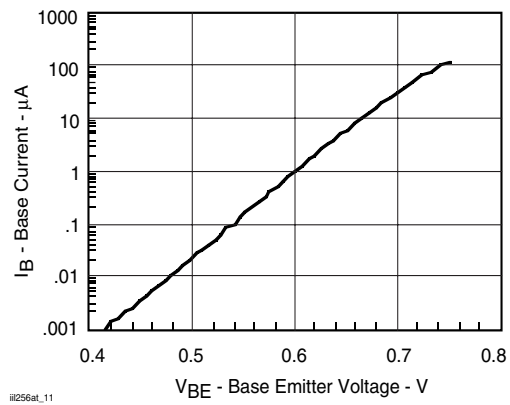

il256at_11

Fig. 11 Base Emitter Voltage vs. Base Current

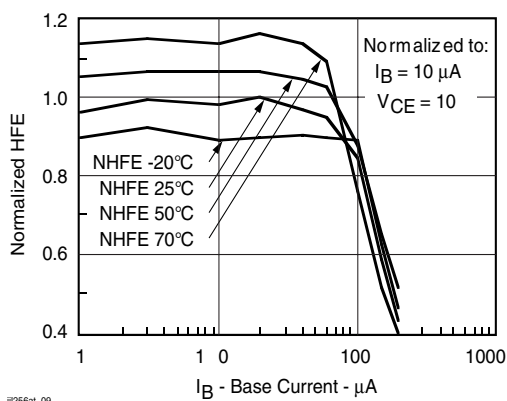

il256at_09

Fig. 9 Normalized HFE vs. Base Current and Temp.

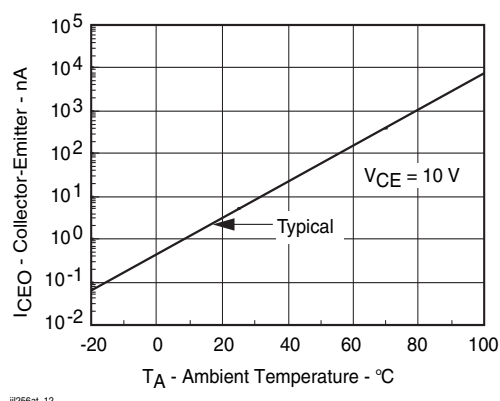

il256at_12

Fig. 12 Collector-Emitter Leakage Current vs. Temp.

Package Dimensions in Inches (mm)

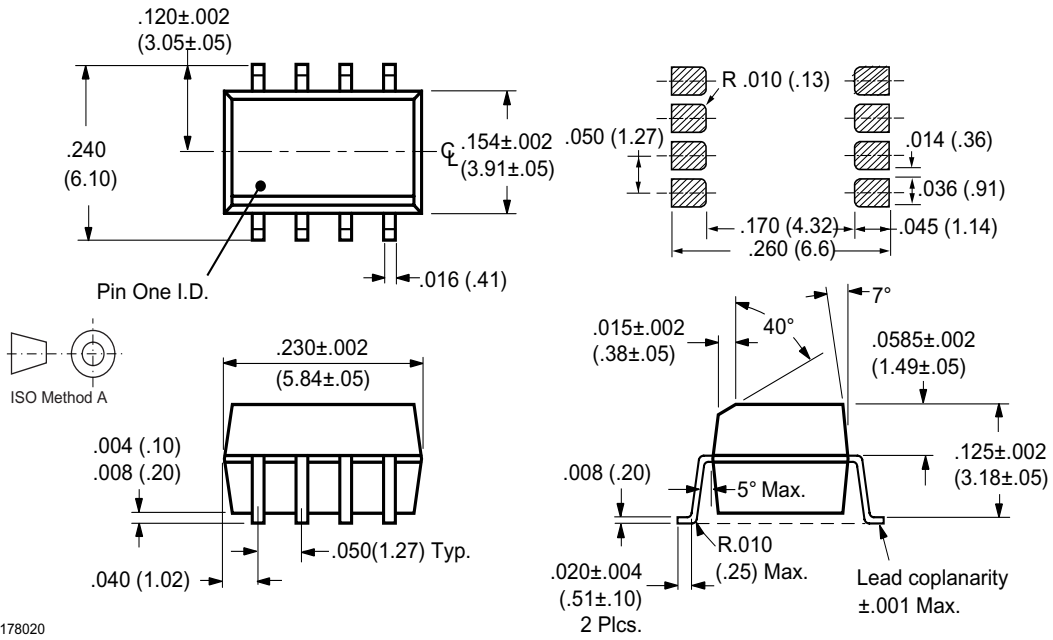

i178020

Ozone Depleting Substances Policy Statement

It is the policy of **Vishay Semiconductor GmbH** to

1. Meet all present and future national and international statutory requirements.
2. Regularly and continuously improve the performance of our products, processes, distribution and operating systems with respect to their impact on the health and safety of our employees and the public, as well as their impact on the environment.

It is particular concern to control or eliminate releases of those substances into the atmosphere which are known as ozone depleting substances (ODSs).

The Montreal Protocol (1987) and its London Amendments (1990) intend to severely restrict the use of ODSs and forbid their use within the next ten years. Various national and international initiatives are pressing for an earlier ban on these substances.

Vishay Semiconductor GmbH has been able to use its policy of continuous improvements to eliminate the use of ODSs listed in the following documents.

1. Annex A, B and list of transitional substances of the Montreal Protocol and the London Amendments respectively
2. Class I and II ozone depleting substances in the Clean Air Act Amendments of 1990 by the Environmental Protection Agency (EPA) in the USA
3. Council Decision 88/540/EEC and 91/690/EEC Annex A, B and C (transitional substances) respectively.

Vishay Semiconductor GmbH can certify that our semiconductors are not manufactured with ozone depleting substances and do not contain such substances.

**We reserve the right to make changes to improve technical design
and may do so without further notice.**

Parameters can vary in different applications. All operating parameters must be validated for each customer application by the customer. Should the buyer use Vishay Semiconductors products for any unintended or unauthorized application, the buyer shall indemnify Vishay Semiconductors against all claims, costs, damages, and expenses, arising out of, directly or indirectly, any claim of personal damage, injury or death associated with such unintended or unauthorized use.

Vishay Semiconductor GmbH, P.O.B. 3535, D-74025 Heilbronn, Germany
Telephone: 49 (0)7131 67 2831, Fax number: 49 (0)7131 67 2423



LittleDiode supplies new, hard to find or obsolete electronic components and semiconductors all over the world.

With over two million different components listed you are sure to find the part you need.

Feel free to visit us today at our online store:

LittleDiode.com

Looking forward to providing you with the best possible service.