

Optocoupler, Phototransistor Output, Dual Channel

Features

- Dual Version of SFH610 Series
- Isolation Test Voltage, 5300 V_{RMS}
- V_{CEsat} 0.25 (≤ 0.4) V at I_F = 10 mA, I_C = 2.5 mA
- V_{CEO} = 70 V
- Lead-free component
- Component in accordance to RoHS 2002/95/EC and WEEE 2002/96/EC

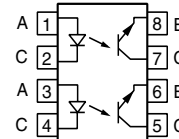
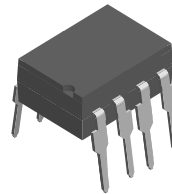

1179045

Agency Approvals

- UL1577, File No. E52744 System Code H or J, Double Protection
- DIN EN 60747-5-2 (VDE0884)
DIN EN 60747-5-5 pending
Available with Option 1
- CSA 93751
- BSI IEC60950 IEC60065

Description

The ILD610 series is a dual channel optocoupler series for high density applications. Each channel consists of an optically coupled pair with a Gallium Arsenide infrared LED and silicon NPN phototransistor. Signal information, including a DC level, can be transmitted by the device while maintaining a high degree of electrical isolation between input and out-

put. The ILD610 series is the dual version of SFH610 series and uses a repetitive pin-out configuration instead of the more common alternating pin-out used in most dual couplers.

Order Information

Part	Remarks
ILD610-1	CTR 40 - 80 %, DIP-8
ILD610-2	CTR 63 - 125 %, DIP-8
ILD610-3	CTR 100 - 200 %, DIP-8
ILD610-4	CTR 160 - 320 %, DIP-8
ILD610-2X007	CTR 63 - 125 %, SMD-8 (option 7)
ILD610-3X006	CTR 100 - 200 %, DIP-8 400 mil (option 6)
ILD610-3X009	CTR 100 - 200 %, SMD-8 (option 9)
ILD610-4X009	CTR 160 - 320 %, SMD-8 (option 9)

For additional information on the available options refer to Option Information.

Absolute Maximum Ratings

T_{amb} = 25 °C, unless otherwise specified

Stresses in excess of the absolute Maximum Ratings can cause permanent damage to the device. Functional operation of the device is not implied at these or any other conditions in excess of those given in the operational sections of this document. Exposure to absolute Maximum Rating for extended periods of the time can adversely affect reliability.

Input

Parameter	Test condition	Symbol	Value	Unit
Reverse voltage		V _R	6.0	V
Surge forward current	t ≤ 10 ms	I _{FSM}	1.5	A
Power dissipation		P _{diss}	100	mW
Derate linearly from 25 °C			1.3	mW/°C
DC forward current		I _F	60	mA

Output

Parameter	Test condition	Symbol	Value	Unit
Collector-emitter voltage		V_{CE}	70	V
Collector current		I_C	50	mA
	$t \leq 1.0$ ms	I_C	100	mA
Power dissipation		P_{diss}	150	mW
Derate linearly from 25 °C			2.0	mW/°C

Coupler

Parameter	Test condition	Symbol	Value	Unit
Isolation test voltage	$t = 1.0$ sec.	V_{ISO}	5300	V_{RMS}
Isolation resistance	$V_{IO} = 500$ V, $T_{amb} = 25$ °C	R_{IO}	$\geq 10^{12}$	Ω
	$V_{IO} = 500$ V, $T_{amb} = 100$ °C	R_{IO}	$\geq 10^{11}$	Ω
Storage temperature		T_{stg}	- 55 to + 150	°C
Operating temperature		T_{amb}	- 55 to + 100	°C
Junction temperature		T_j	100	°C
Lead soldering time at 260 °C			10	sec.

Electrical Characteristics

$T_{amb} = 25$ °C, unless otherwise specified

Minimum and maximum values are testing requirements. Typical values are characteristics of the device and are the result of engineering evaluation. Typical values are for information only and are not part of the testing requirements.

Input

Parameter	Test condition	Symbol	Min	Typ.	Max	Unit
Forward voltage	$I_F = 60$ mA	V_F		1.25	1.65	V
Reverse current	$V_R = 6.0$ V	I_R		0.01	10	μ A
Capacitance	$V_R = 0$ V, $f = 1.0$ MHz	C_O		25		pF

Output

Parameter	Test condition	Part	Symbol	Min	Typ.	Max	Unit
Collector-emitter breakdown voltage	$I_C = 10$ mA, $I_E = 10$ μ A		BV_{CEO}	70	90		V
			BV_{CEO}	6.0	7.0		V
Collector-emitter dark current	$V_{CE} = 10$ V		I_{CEO}		2.0	50	nA
Collector-emitter capacitance	$V_{CE} = 5.0$ V, $f = 1.0$ MHz		C_{CE}		7.0		pF
Collector-emitter leakage current	$V_{CE} = 10$ V	ILD610-1	I_{CEO}		2.0	50	nA
		ILD610-2	I_{CEO}		2.0	50	nA
		ILD610-3	I_{CEO}		5.0	100	nA
		ILD610-4	I_{CEO}		5.0	100	nA

Coupler

Parameter	Test condition	Symbol	Min	Typ.	Max	Unit
Collector-emitter saturation voltage	$I_F = 10$ mA, $I_C = 2.5$ mA	V_{CEsat}		0.25	0.40	V
Coupling capacitance		C_C		0.35		pF

Current Transfer Ratio

Parameter	Test condition	Part	Symbol	Min	Typ.	Max	Unit
CTR ¹⁾	$I_F = 10 \text{ mA}, V_{CE} = 5.0 \text{ V}$	ILD610-1	CTR	40		80	%
		ILD610-2	CTR	63		125	%
		ILD610-3	CTR	100		200	%
		ILD610-4	CTR	160		320	%
	$I_F = 1.0 \text{ mA}, V_{CE} = 5.0 \text{ V}$	ILD610-1	CTR	13			%
		ILD610-2	CTR	22			%
		ILD610-3	CTR	34			%
		ILD610-4	CTR	56			%

¹⁾CTR will match within a ratio of 1.7:1

Switching Characteristics

Non-saturated

Parameter	Test condition	Part	Symbol	Min	Typ.	Max	Unit
Rise time	$V_{CC} = 5.0, R_L = 75 \Omega, I_F = 10 \text{ mA}$	ILD610-1	t_r		2.0		μ
		ILD610-2	t_r		2.5		μ
		ILD610-3	t_r		2.9		μ
		ILD610-4	t_r		3.3		μ
Fall time	$V_{CC} = 5.0, R_L = 75 \Omega, I_F = 10 \text{ mA}$	ILD610-1	t_f		2.0		μ
		ILD610-2	t_f		2.6		μ
		ILD610-3	t_f		3.1		μ
		ILD610-4	t_f		3.5		μ
Turn-on time	$V_{CC} = 5.0, R_L = 75 \Omega, I_F = 10 \text{ mA}$	ILD610-1	t_{on}		3.0		μ
		ILD610-2	t_{on}		3.2		μ
		ILD610-3	t_{on}		3.6		μ
		ILD610-4	t_{on}		2.3		μ
Turn-off time	$V_{CC} = 5.0, R_L = 75 \Omega, I_F = 10 \text{ mA}$	ILD610-1	t_{off}		2.9		μ
		ILD610-2	t_{off}		3.4		μ
		ILD610-3	t_{off}		3.7		μ
		ILD610-4	t_{off}		4.1		μ

Saturated

Parameter	Test condition	Part	Symbol	Min	Typ.	Max	Unit
Rise time	$V_{CC} = 5.0, R_L = 1.0 \text{ k}\Omega, I_F = 5.0 \text{ mA}$	ILD610-1	t_r		2.0		μ
		ILD610-2	t_r		2.8		μ
		ILD610-3	t_r		3.3		μ
		ILD610-4	t_r		4.6		μ
Fall time	$V_{CC} = 5.0, R_L = 1.0 \text{ k}\Omega, I_F = 5.0 \text{ mA}$	ILD610-1	t_f		11		μ
		ILD610-2	t_f		2.6		μ
		ILD610-3	t_f		3.1		μ
		ILD610-4	t_f		15		μ
Turn-on time	$V_{CC} = 5.0, R_L = 1.0 \text{ k}\Omega, I_F = 5.0 \text{ mA}$	ILD610-1	t_{on}		3.0		μ
		ILD610-2	t_{on}		4.3		μ
		ILD610-3	t_{on}		4.6		μ
		ILD610-4	t_{on}		6.0		μ



Parameter	Test condition	Part	Symbol	Min	Typ.	Max	Unit
Turn-off time	$V_{CC} = 5.0, R_L = 1.0 \text{ k}\Omega, I_F = 5.0 \text{ mA}$	ILD610-1	t_{off}		18		μ
		ILD610-2	t_{off}		2.9		μ
		ILD610-3	t_{off}		3.4		μ
		ILD610-4	t_{off}		25		μ

Typical Characteristics ($T_{amb} = 25^\circ\text{C}$ unless otherwise specified)

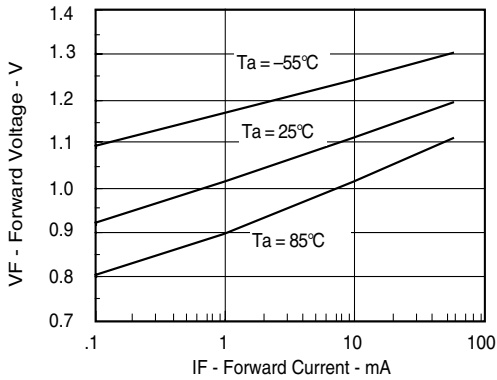

ilc6_01

Figure 1. Forward Voltage vs. Forward Current

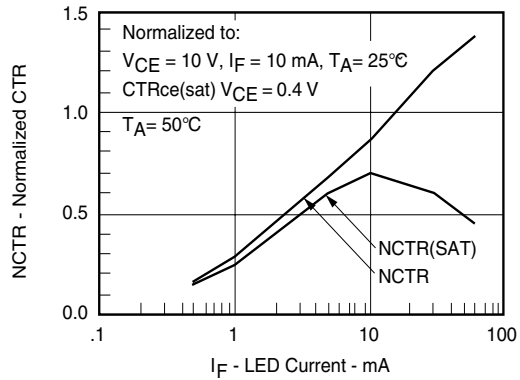

ilc6_03

Figure 3. Normalized Non-Saturated and Saturated CTR vs. LED Current

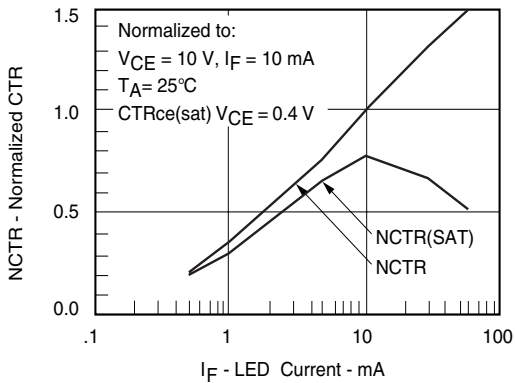

ilc6_02

Figure 2. Normalized Non-Saturated and Saturated CTR vs. LED Current

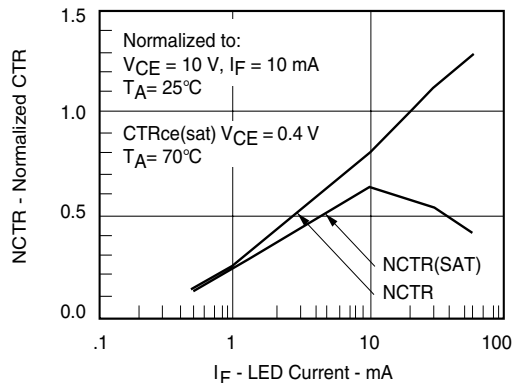

ilc6_04

Figure 4. Normalized Non-Saturated and Saturated CTR vs. LED Current

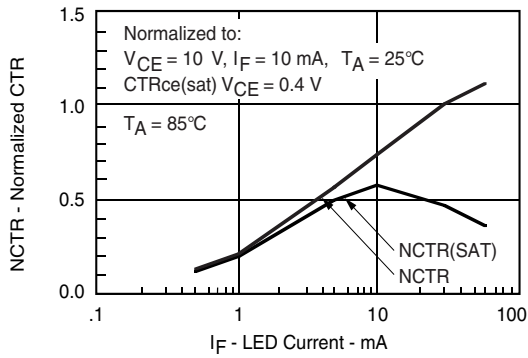

ilc6_05

Figure 5. Normalized Non-Saturated and Saturated CTR vs. LED Current

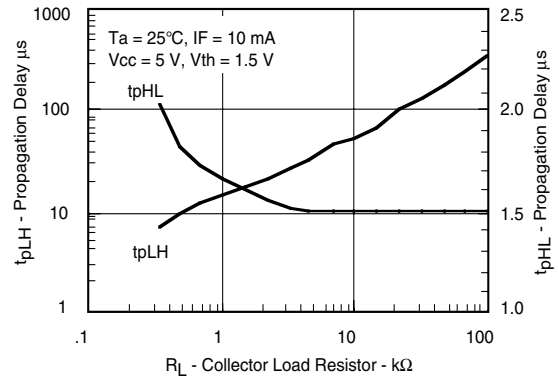

ilc6_08

Figure 8. Propagation Delay vs. Collector Load Resistor

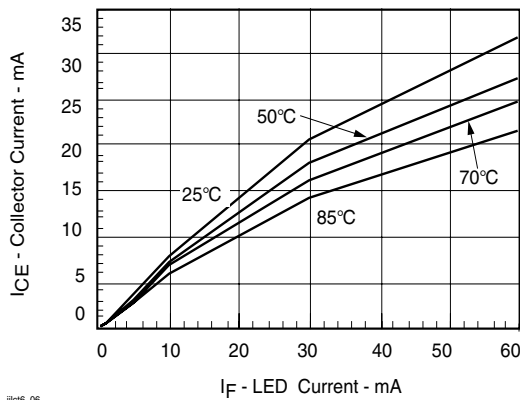

ilc6_06

Figure 6. Collector-Emitter Current vs. Temperature and LED Current

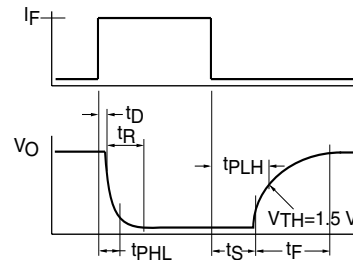

ild610_09

Figure 9. Switching Timing

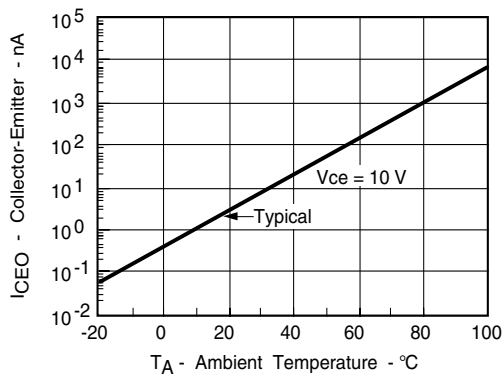

ilc6_07

Figure 7. Collector-Emitter Leakage Current vs. Temp.

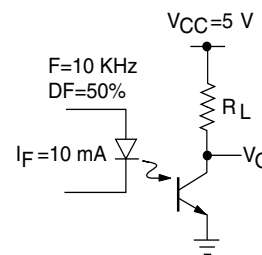

ild610_10

Figure 10. Non-saturated Switching Schematic

Figure 11. Saturated Switching Time Test Waveform

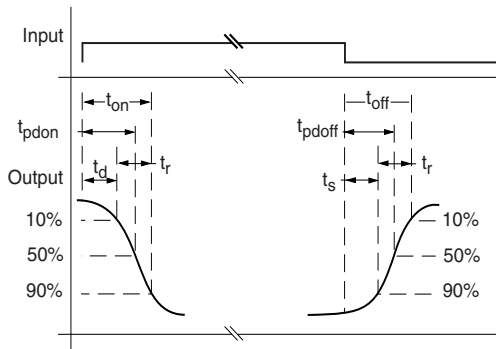

ild610_11

Package Dimensions in Inches (mm)

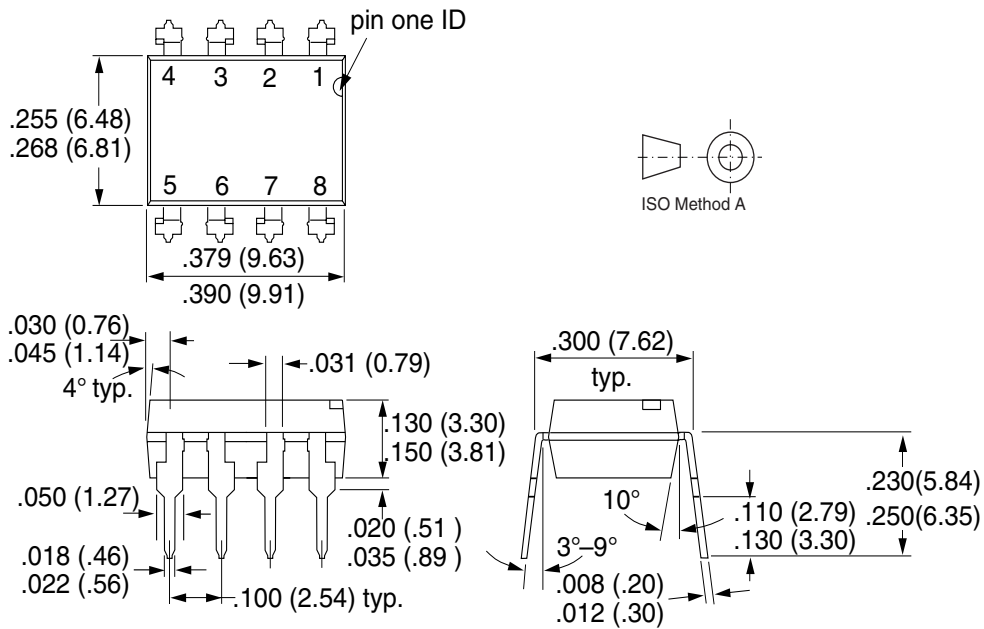

i178006

Option 6

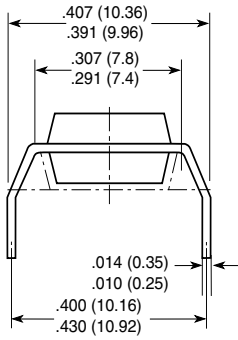

Option 7

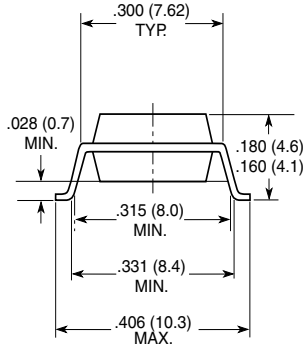

Option 9

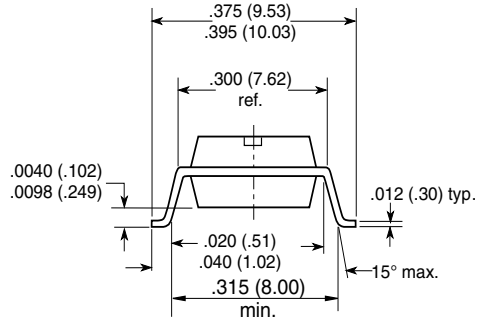

18450

Ozone Depleting Substances Policy Statement

It is the policy of Vishay Semiconductor GmbH to

1. Meet all present and future national and international statutory requirements.
2. Regularly and continuously improve the performance of our products, processes, distribution and operating systems with respect to their impact on the health and safety of our employees and the public, as well as their impact on the environment.

It is particular concern to control or eliminate releases of those substances into the atmosphere which are known as ozone depleting substances (ODSs).

The Montreal Protocol (1987) and its London Amendments (1990) intend to severely restrict the use of ODSs and forbid their use within the next ten years. Various national and international initiatives are pressing for an earlier ban on these substances.

Vishay Semiconductor GmbH has been able to use its policy of continuous improvements to eliminate the use of ODSs listed in the following documents.

1. Annex A, B and list of transitional substances of the Montreal Protocol and the London Amendments respectively
2. Class I and II ozone depleting substances in the Clean Air Act Amendments of 1990 by the Environmental Protection Agency (EPA) in the USA
3. Council Decision 88/540/EEC and 91/690/EEC Annex A, B and C (transitional substances) respectively.

Vishay Semiconductor GmbH can certify that our semiconductors are not manufactured with ozone depleting substances and do not contain such substances.

We reserve the right to make changes to improve technical design
and may do so without further notice.

Parameters can vary in different applications. All operating parameters must be validated for each customer application by the customer. Should the buyer use Vishay Semiconductors products for any unintended or unauthorized application, the buyer shall indemnify Vishay Semiconductors against all claims, costs, damages, and expenses, arising out of, directly or indirectly, any claim of personal damage, injury or death associated with such unintended or unauthorized use.

Vishay Semiconductor GmbH, P.O.B. 3535, D-74025 Heilbronn, Germany
Telephone: 49 (0)7131 67 2831, Fax number: 49 (0)7131 67 2423



LittleDiode supplies new, hard to find or obsolete electronic components and semiconductors all over the world.

With over two million different components listed you are sure to find the part you need.

Feel free to visit us today at our online store:

LittleDiode.com

Looking forward to providing you with the best possible service.