

Optocoupler, Photodarlington Output, AC Input, Internal R_{BE}

Features

- Internal R_{BE} for Better Stability
- BV_{CEO} > 60 V
- AC or Polarity Insensitive Inputs
- Built-In Reverse Polarity Input Protection
- Industry Standard DIP Package
- Lead-free component
- Component in accordance to RoHS 2002/95/EC and WEEE 2002/96/EC

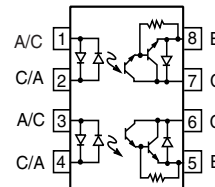
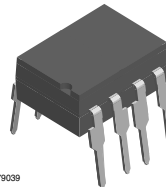
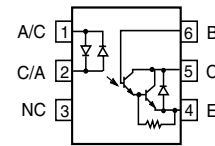
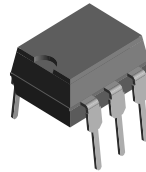

1179039



Agency Approvals

- UL1577, File No. E52744 System Code H or J, Double Protection
- CSA 93751
- BSI IEC60950 IEC60065

The IL766 is single channel optocouplers. The ILD766 has two isolated channels in a single DIP package.

Applications

Designed for applications requiring detection or monitoring of AC signals.

Order Information

Part	Remarks
ILD766-1	CTR > 500 @ I _F = 2.0 mA, DIP-8
ILD766-2	CTR > 500 @ I _F = 1.0 mA, DIP-8
IL766-1	CTR > 500 @ I _F = 2.0 mA, DIP-6
IL766-2	CTR > 500 @ I _F = 1.0 mA, DIP-6
IL766-1X007	CTR > 500 @ I _F = 2.0 mA, SMD-6 (option 7)

Description

The IL766/ ILD766 are bidirectional input optically coupled isolators. They consist of two Gallium Arsenide infrared emitting diodes coupled to a silicon NPN photodarlington per channel.

For additional information on the available options refer to Option Information.

Absolute Maximum Ratings

T_{amb} = 25 °C, unless otherwise specified

Stresses in excess of the absolute Maximum Ratings can cause permanent damage to the device. Functional operation of the device is not implied at these or any other conditions in excess of those given in the operational sections of this document. Exposure to absolute Maximum Rating for extended periods of the time can adversely affect reliability.

Input

Each Channel

Parameter	Test condition	Symbol	Value	Unit
Forward continuous current		I _F	60	mA
Power dissipation, single channel		P _{diss}	200	mW
Power dissipation, dual channel		P _{diss}	90	mW
Derate linearly from 25 °C, single channel			2.6	mW/°C
Derate linearly from 25 °C, dual channel			1.2	mW/°C

Output

Each Channel

Parameter	Test condition	Symbol	Value	Unit
Collector-emitter breakdown voltage		BV_{CEO}	60	V
Collector-base breakdown voltage		BV_{CBO}	70	V
Power dissipation		P_{diss}	100	mW
Derate linearly from 25 °C			1.33	mW/°C

Coupler

Parameter	Test condition	Symbol	Value	Unit
Isolation test voltage	t = 1.0 sec.	V_{ISO}	5300	V_{RMS}
Isolation resistance	$T_{amb} = 25\text{ °C}$	R_{IO}	$\geq 10^{12}$	Ω
	$T_{amb} = 100\text{ °C}$	R_{IO}	$\geq 10^{11}$	Ω
Total power dissipation (LED plus detector), single channel		P_{tot}	250	mW
Total power dissipation (LED plus detector), dual channel		P_{tot}	400	mW
Derate linearly from 25 °C, single channel			3.3	mW/°C
Derate linearly from 25 °C, dual channel			5.3	mW/°C
Creepage			≥ 7.0	mm
Clearance			≥ 7.0	mm
Comparative tracking index per DIN IEC 112/VDE0303, part 1			175	
Storage temperature		T_{stg}	- 55 to + 150	°C
Operating temperature		T_{amb}	- 55 to +100	°C
Lead soldering time at 260 °C		T_{sld}	10	sec.

Electrical Characteristics

$T_{amb} = 25\text{ °C}$, unless otherwise specified

Minimum and maximum values are testing requirements. Typical values are characteristics of the device and are the result of engineering evaluation. Typical values are for information only and are not part of the testing requirements.

Input

Parameter	Test condition	Symbol	Min	Typ.	Max	Unit
Forward voltage	$I_F = \pm 10\text{ mA}$	V_F		1.2	1.5	V

Output

Parameter	Test condition	Symbol	Min	Typ.	Max	Unit
Collector-emitter breakdown voltage	$I_C = 1.0\text{ mA}$	BV_{CEO}	60	75		V
Collector-base breakdown voltage	$I_C = 10\text{ }\mu\text{A}$	BV_{CBO}	60	90		V
Collector-emitter leakage current	$V_{CE} = 10\text{ V}$	I_{CEO}		10	100	nA

Coupler

Parameter	Test condition	Symbol	Min	Typ.	Max	Unit
Saturation voltage, collector-emitter	$I_F = \pm 10\text{ mA}$, $I_C = 10\text{ mA}$	V_{CEsat}			1.0	V

Current Transfer Ratio

Parameter	Test condition	Symbol	Min	Typ.	Max	Unit
DC Current Transfer Ratio	$V_{CE} = 5.0 \text{ V}$, $I_F = \pm 2.0 \text{ mA}$,	CTR_{DC}	500			%

Switching Characteristics

Parameter	Test condition	Symbol	Min	Typ.	Max	Unit
Rise time, fall time	$V_{CC} = 10 \text{ V}$, $I_F = \pm 2.0 \text{ mA}$, $R_L = 100 \Omega$	t_r , t_f		100		μs

Typical Characteristics (Tamb = 25 °C unless otherwise specified)

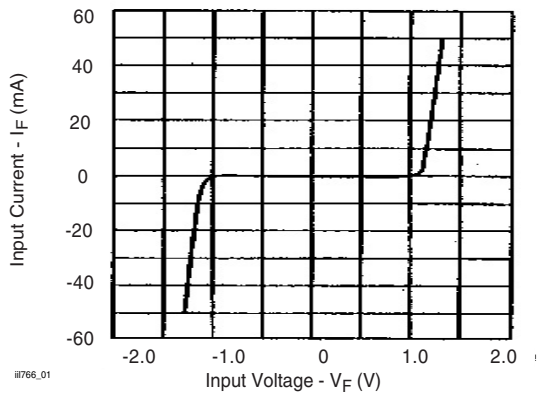

Figure 1. Input Characteristics

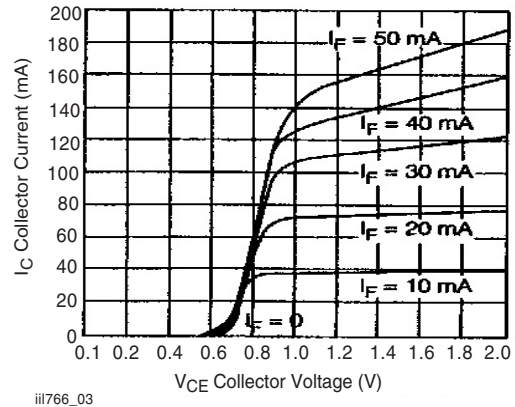

Figure 3. Transistor Output Current vs. Voltage

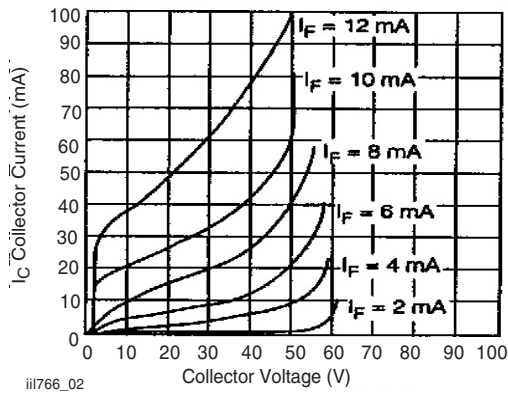

Figure 2. Transistor Current vs. Voltage

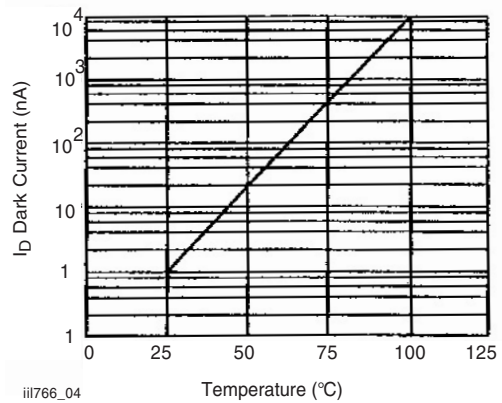

Figure 4. I_{CEO} at $V_{CE} = 10 \text{ V}$ vs. Temperature

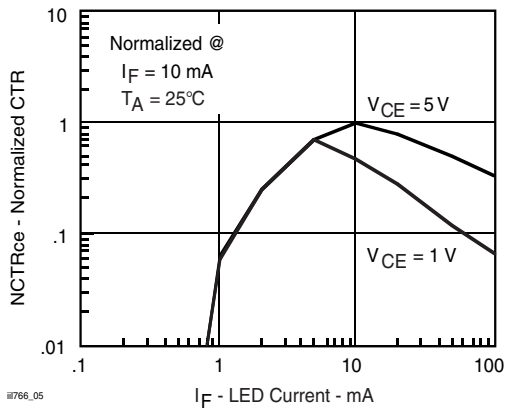

Figure 5. Normalized CTR vs. Forward Current

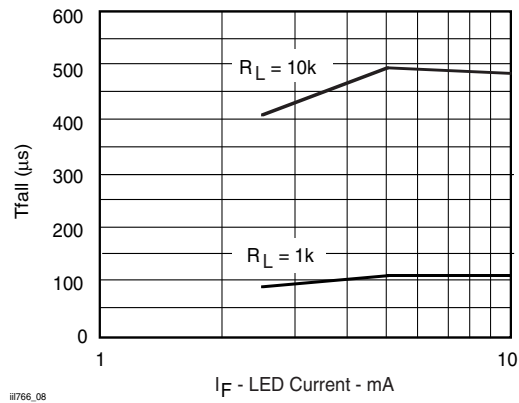

Figure 8. t_{fall} vs. Forward Current

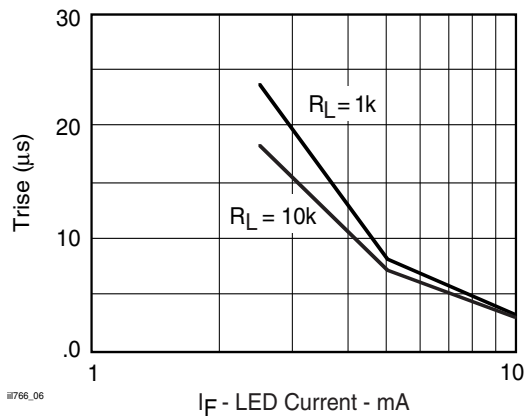

Figure 6. t_r vs. Forward Current

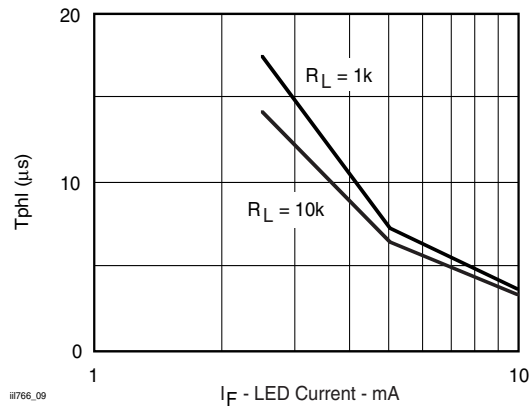

Figure 9. t_{on} vs. Forward Current

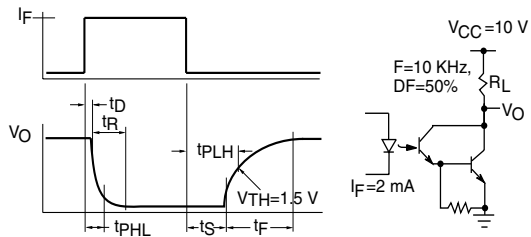

Figure 7. Saturated Switching Characteristics Measurements- Schematic and Waveform

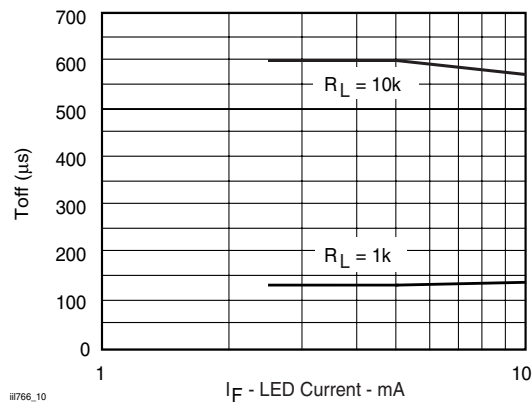

Figure 10. t_{off} vs. Forward Current

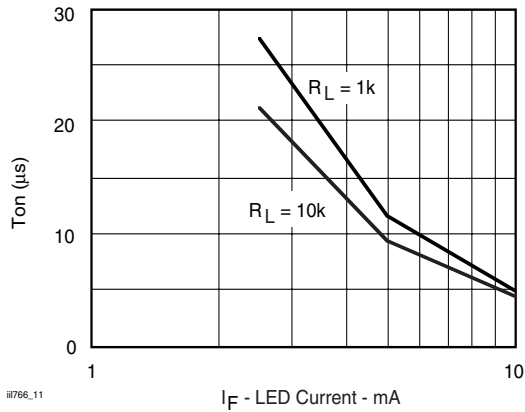

Figure 11. t_{phl} vs. Forward Current

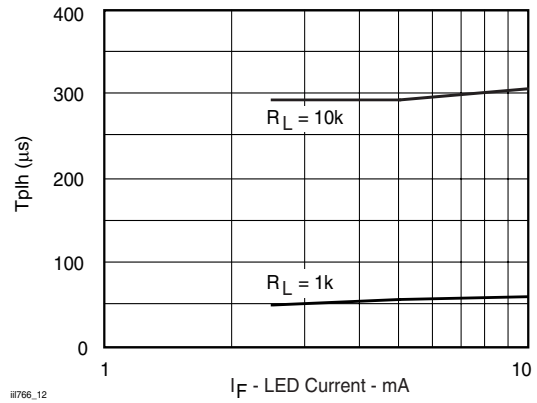
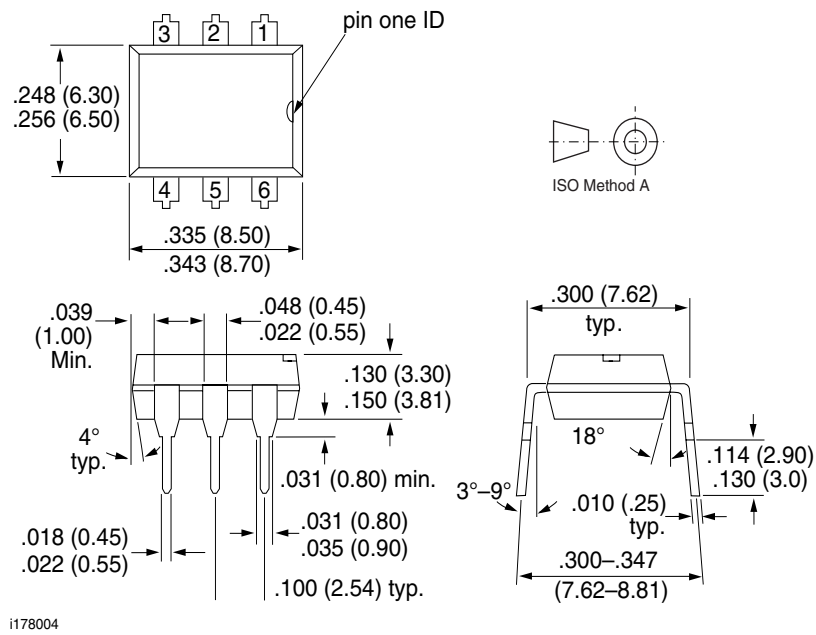
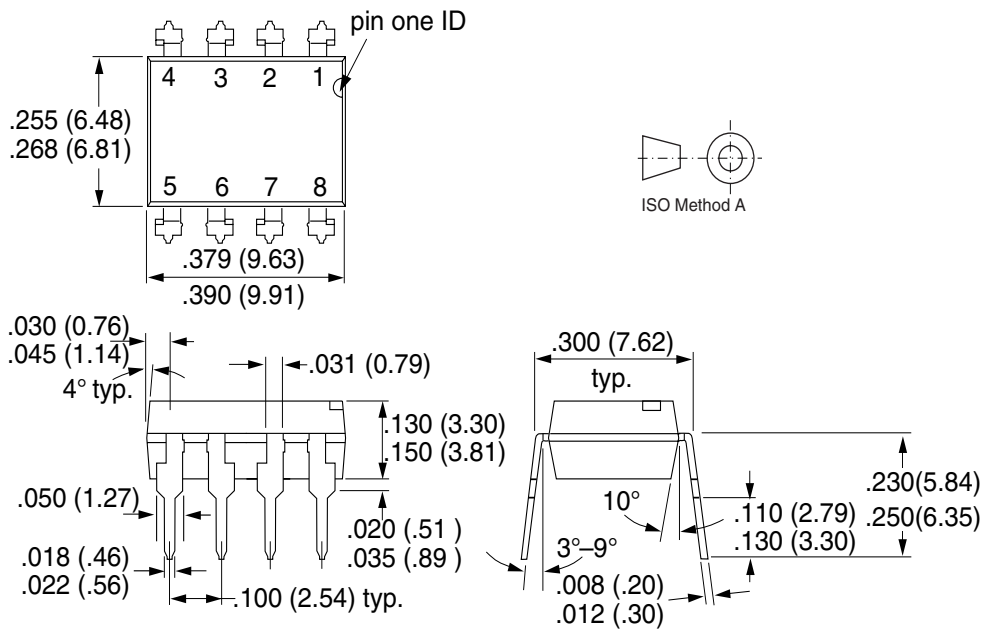

Figure 12. t_{plh} vs. Forward Current

Package Dimensions in Inches (mm)



Package Dimensions in Inches (mm)



1178006

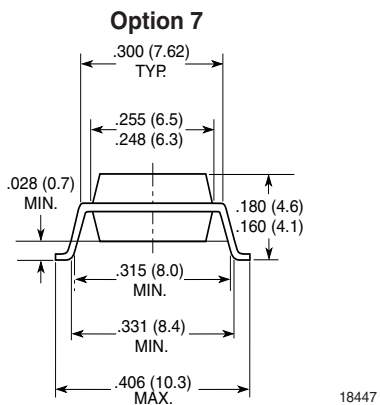



Ozone Depleting Substances Policy Statement

It is the policy of Vishay Semiconductor GmbH to

1. Meet all present and future national and international statutory requirements.
2. Regularly and continuously improve the performance of our products, processes, distribution and operating systems with respect to their impact on the health and safety of our employees and the public, as well as their impact on the environment.

It is particular concern to control or eliminate releases of those substances into the atmosphere which are known as ozone depleting substances (ODSs).

The Montreal Protocol (1987) and its London Amendments (1990) intend to severely restrict the use of ODSs and forbid their use within the next ten years. Various national and international initiatives are pressing for an earlier ban on these substances.

Vishay Semiconductor GmbH has been able to use its policy of continuous improvements to eliminate the use of ODSs listed in the following documents.

1. Annex A, B and list of transitional substances of the Montreal Protocol and the London Amendments respectively
2. Class I and II ozone depleting substances in the Clean Air Act Amendments of 1990 by the Environmental Protection Agency (EPA) in the USA
3. Council Decision 88/540/EEC and 91/690/EEC Annex A, B and C (transitional substances) respectively.

Vishay Semiconductor GmbH can certify that our semiconductors are not manufactured with ozone depleting substances and do not contain such substances.

We reserve the right to make changes to improve technical design and may do so without further notice.

Parameters can vary in different applications. All operating parameters must be validated for each customer application by the customer. Should the buyer use Vishay Semiconductors products for any unintended or unauthorized application, the buyer shall indemnify Vishay Semiconductors against all claims, costs, damages, and expenses, arising out of, directly or indirectly, any claim of personal damage, injury or death associated with such unintended or unauthorized use.

Vishay Semiconductor GmbH, P.O.B. 3535, D-74025 Heilbronn, Germany
Telephone: 49 (0)7131 67 2831, Fax number: 49 (0)7131 67 2423



LittleDiode supplies new, hard to find or obsolete electronic components and semiconductors all over the world.

With over two million different components listed you are sure to find the part you need.

Feel free to visit us today at our online store:

LittleDiode.com

Looking forward to providing you with the best possible service.