

**FAST DIODES**
**SUPER MAGN-A-pak™ Power Modules**
**Features**

- High power FAST recovery diode series
- High current capability
- 3000 V<sub>RMS</sub> isolating voltage with non-toxic substrate
- High surge capability
- High voltage ratings up to 2500V
- Industrial standard package
- UL recognition pending

**460 A**
**Typical Applications**

- Snubber for large GTO
- Snubber for large IGBT

**Major Ratings and Characteristics**

Parameters	IRKDL450..S20	Units	
$I_{F(AV)}$	460	A	
@ $T_C$	82	°C	
$I_{F(RMS)}$	720	A	
@ $T_C$	82	°C	
$I_{FSM}$	@ 50Hz	13.0	KA
	@ 60Hz	13.8	KA
$I^2t$	@ 50Hz	845	KA <sup>2</sup> s
	@ 60Hz	790	KA <sup>2</sup> s
$I^2\sqrt{t}$		8450	KA <sup>2</sup> √s
$V_{RRM}$	range	1600 to 2500	V
$t_{rr}$		4.0	μs
$T_{STG}$	range	-40 to 150	°C
$T_J$	range	-40 to 150	°C

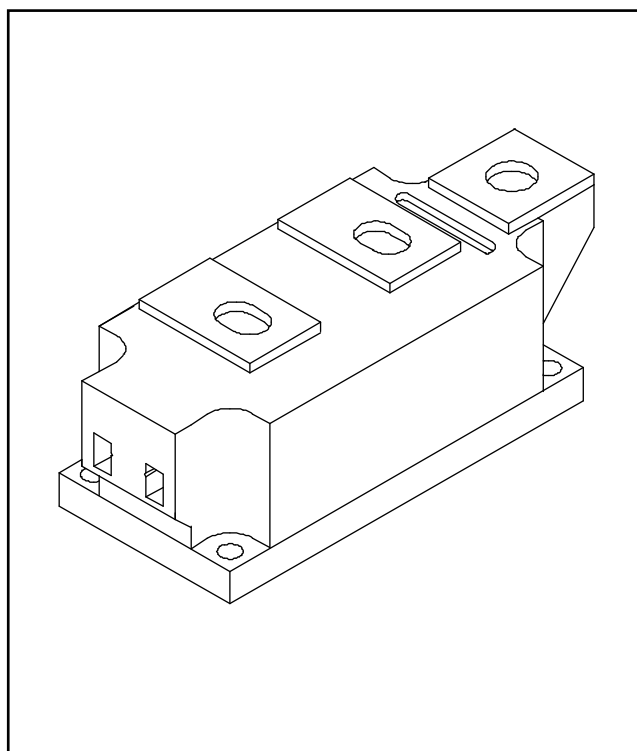

**ELECTRICAL SPECIFICATIONS**

**Voltage Ratings**

Type number	Voltage Code	$V_{RRM}$ , maximum repetitive peak reverse voltage V	$V_{RSM}$ , maximum non-repetitive peak rev. voltage V	$I_{RRM}$ max. @ $T_J$ max. mA
IRKDL450..S20	16	1600	1700	50
	20	2000	2100	
	25	2500	2600	

**Forward Conduction**

Parameter	IRKDL450..	Units	Conditions
$I_{F(AV)}$ Maximum average forward current @ Case temperature	460	A	180° conduction, half sine wave
	82	°C	
$I_{F(RMS)}$ Maximum RMS forward current	720	A	180° conduction, half sine wave @ $T_C = 82^\circ\text{C}$
$I_{FSM}$ Maximum peak, one-cycle forward, non-repetitive surge current	13.0	KA	t = 10ms No voltage reappplied
	13.8		t = 8.3ms reappplied
	11.1		t = 10ms 100% $V_{RRM}$ reappplied
	11.8		t = 8.3ms reappplied
$I^2t$ Maximum $I^2t$ for fusing	845	KA <sup>2</sup> s	t = 10ms No voltage reappplied
	790		t = 8.3ms reappplied
	616		t = 10ms 100% $V_{RRM}$ reappplied
	578		t = 8.3ms reappplied
$I^2\sqrt{t}$ Maximum $I^2\sqrt{t}$ for fusing	8450	KA <sup>2</sup> $\sqrt{s}$	t = 0.1 to 10ms, no voltage reappplied
$V_{F(TO)1}$ Low level value of threshold voltage	1.16	V	$(16.7\% \times \pi \times I_{F(AV)} < I < \pi \times I_{F(AV)})$ , $T_J = T_J$ max.
$V_{F(TO)2}$ High level value of threshold voltage	1.62	V	$(I > \pi \times I_{F(AV)})$ , $T_J = T_J$ max.
$r_{f1}$ Low level value of forward slope resistance	0.68	m $\Omega$	$(16.7\% \times \pi \times I_{F(AV)} < I < \pi \times I_{F(AV)})$ , $T_J = T_J$ max.
$r_{f2}$ High level value of forward slope resistance	0.41	m $\Omega$	$(I > \pi \times I_{F(AV)})$ , $T_J = T_J$ max.
$V_{FM}$ Maximum forward voltage drop	2.20	V	$I_{pk} = 1800\text{A}$ , $T_J = 25^\circ\text{C}$ , $t_p = 10\text{ms}$ sine pulse

**Recovery Characteristics**

Code	$T_J = 25^\circ\text{C}$ typical $t_{rr}$ @ 25% $I_{RRM}$ ( $\mu\text{s}$ )	Test conditions			Max. values @ $T_J = 150^\circ\text{C}$			
		$I_{pk}$ Square Pulse (A)	$di/dt$ (A/ $\mu\text{s}$ )	$V_r$ (V)	$t_{rr}$ @ 25% $I_{RRM}$ ( $\mu\text{s}$ )	$Q_{rr}$ ( $\mu\text{C}$ )	$I_{rr}$ (A)	
S20	2.0	1000	100	-50	4.0	400	180	

**Blocking**

Parameter	IRKDL450..	Units	Conditions
$V_{INS}$ RMS isolation voltage	3000	V	t = 1 s
$I_{RRM}$ Maximum peak reverse and off-state leakage current	50	mA	$T_J = T_J$ max., rated $V_{RRM}$ applied

Thermal and Mechanical Specifications

Parameter	IRKDL450..	Units	Conditions
$T_J$ Max. junction operating temperature range	- 40 to 150	°C	
$T_{stg}$ Max. storage temperature range	- 40 to 150		
$R_{thJC}$ Max. thermal resistance, junction to case	0.065	K/W	Per junction, DC operation
$R_{thC-hs}$ Max. thermal resistance, case to heatsink	0.02	K/W	
T Mounting torque $\pm 10\%$ SMAP to heatsink	6 - 8	Nm	A mounting compound is recommended and the torque should be rechecked after a period of 3 hours to allow for the spread of the compound
	busbar to SMAP		
wt Approximate weight	1500	g	
Case style	SUPER MAGN-A-pak		See outline table

$\Delta R_{thJC}$  Conduction

(The following table shows the increment of thermal resistance  $R_{thJC}$  when devices operate at different conduction angles than DC)

Conduction angle	Sinusoidal conduction	Rectangular conduction	Units	Conditions
180°	0.009	0.006	K/W	$T_J = T_J \text{ max.}$
120°	0.011	0.011		
90°	0.014	0.015		
60°	0.021	0.022		
30°	0.037	0.038		

Ordering Information Table

**Device Code**

IRK	D	L	450	-	25	S20
-----	---	---	-----	---	----	-----

(1)
(2)
(3)
(4)
(5)
(6)

- 1** - Module type
- 2** - Circuit configuration D = 2 diodes in series
- 3** - Fast recovery
- 4** - Current rating
- 5** - Voltage code: Code x 100 =  $V_{RRM}$  (See Voltage Ratings Table)
- 6** -  $t_{rr}$  code (see Recovery Characteristics table)

Outline Table

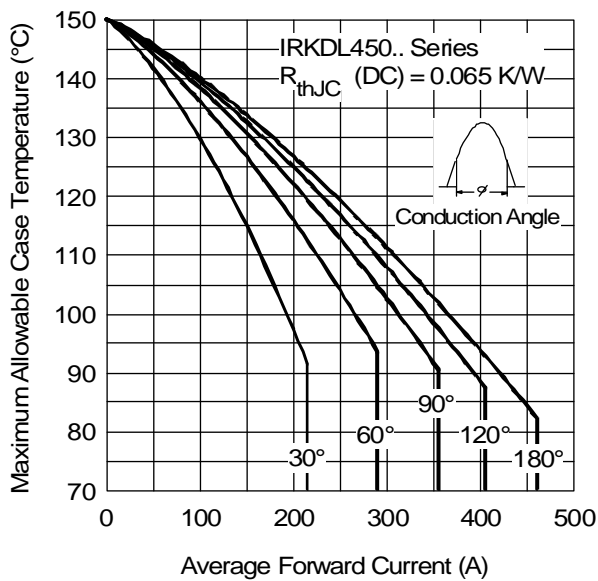
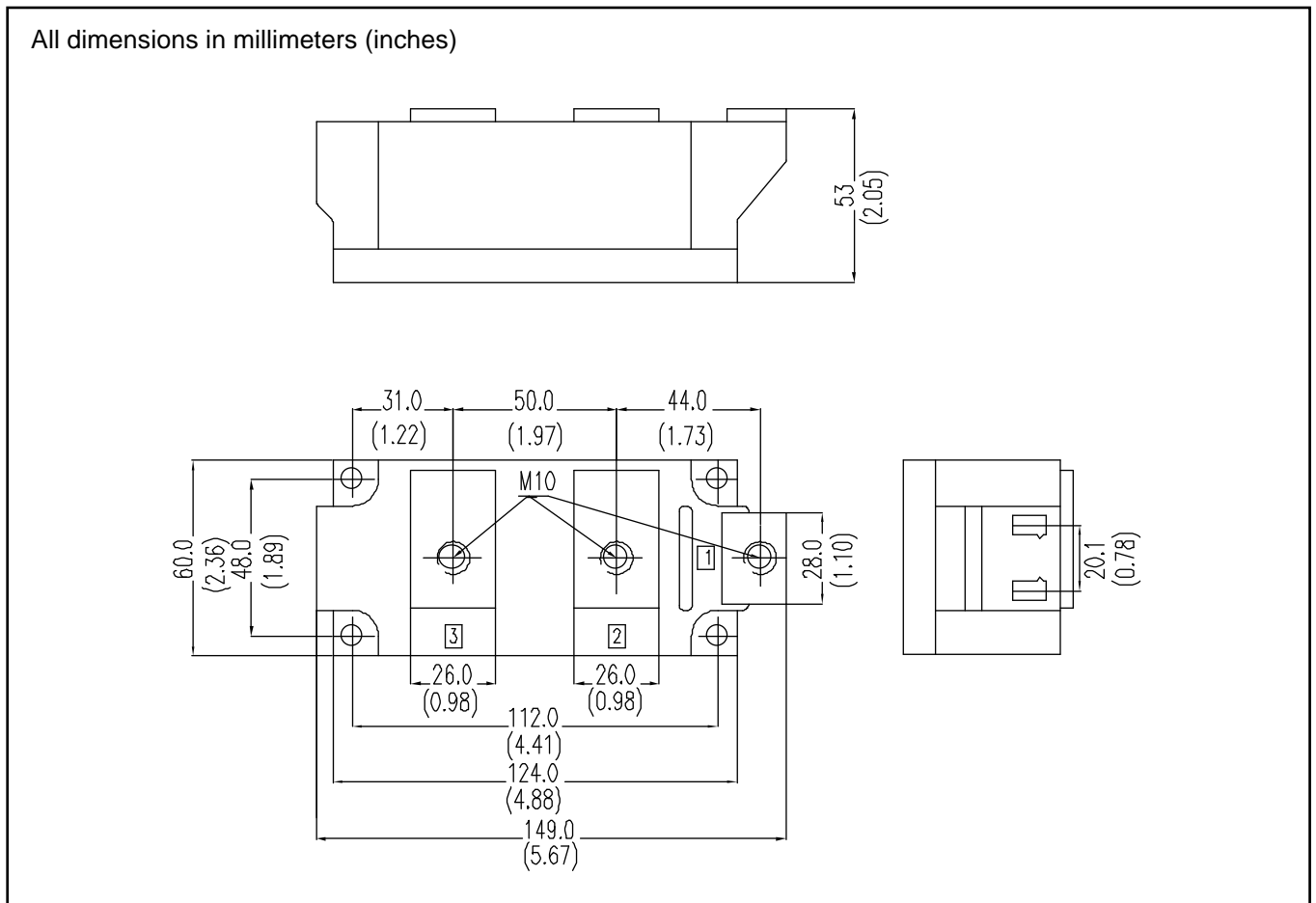

Fig. 1 - Current Ratings Characteristics

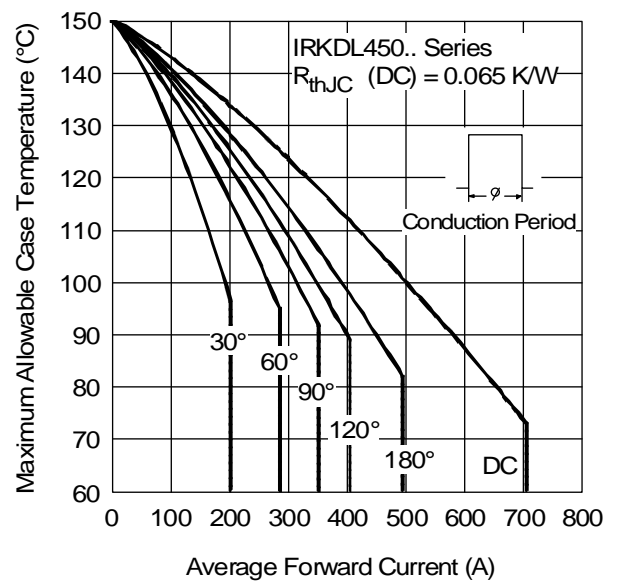

Fig. 2 - Current Ratings Characteristics

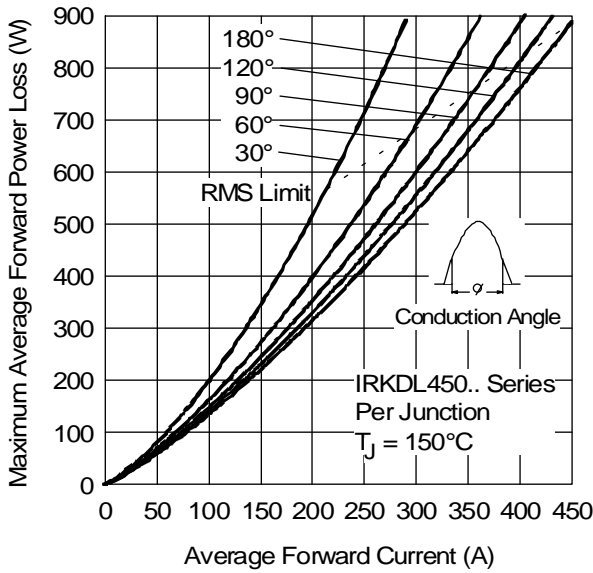

Fig. 3 - Forward Power Loss Characteristics

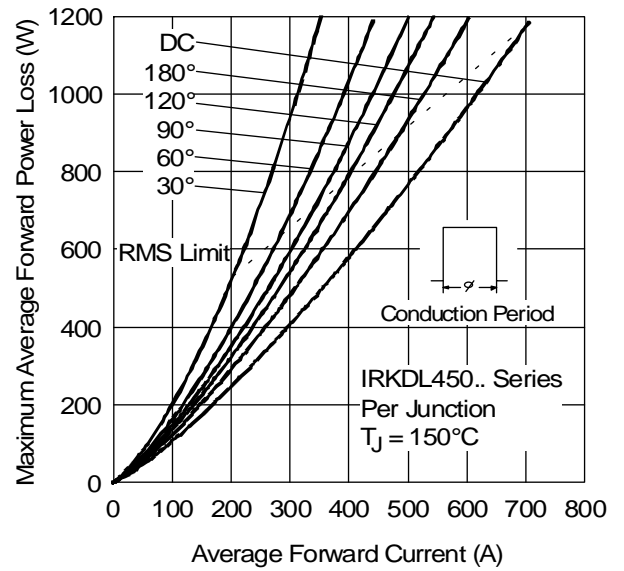

Fig. 4 - Forward Power Loss Characteristics

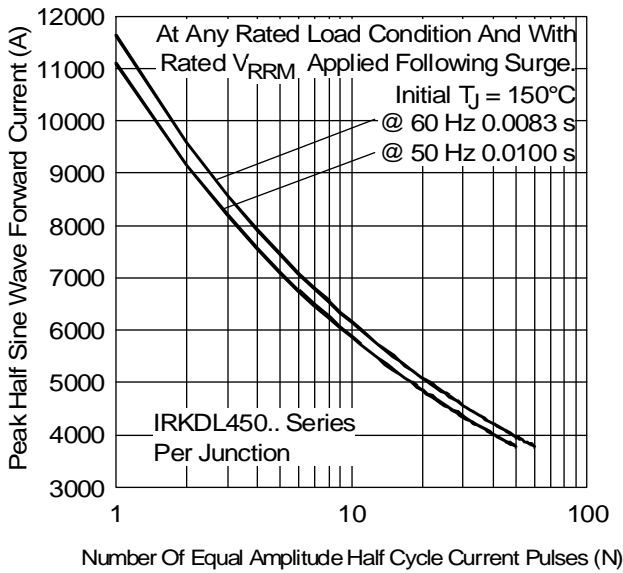

Fig. 5 - Maximum Non-Repetitive Surge Current

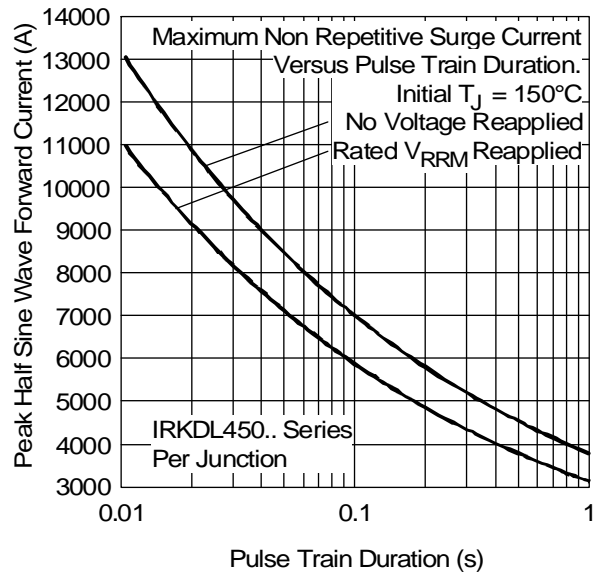

Fig. 6 - Maximum Non-Repetitive Surge Current

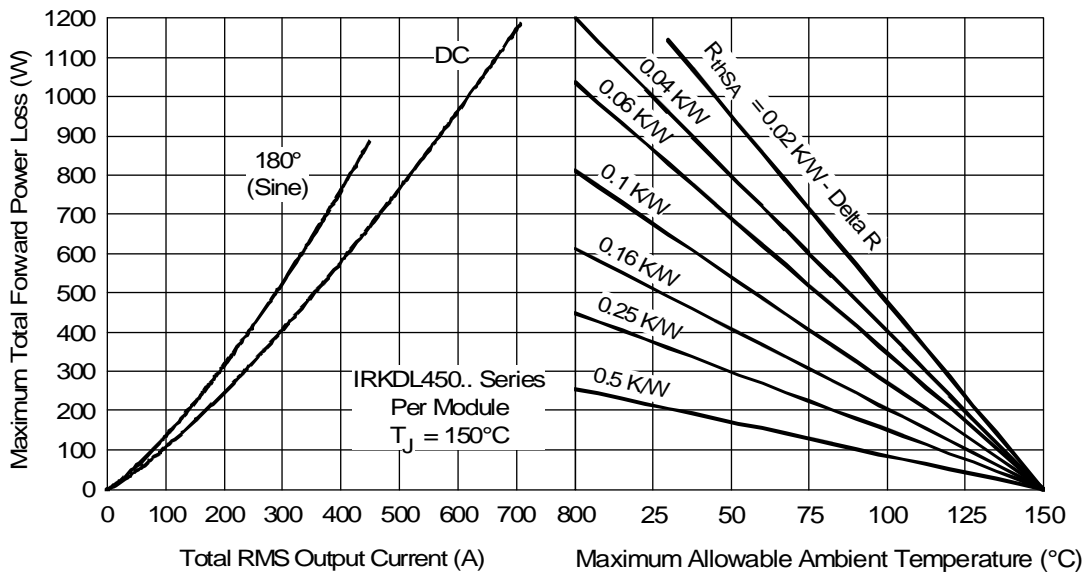

Fig. 7 - Forward Power Loss Characteristics

# IRKDL450..S20 Series

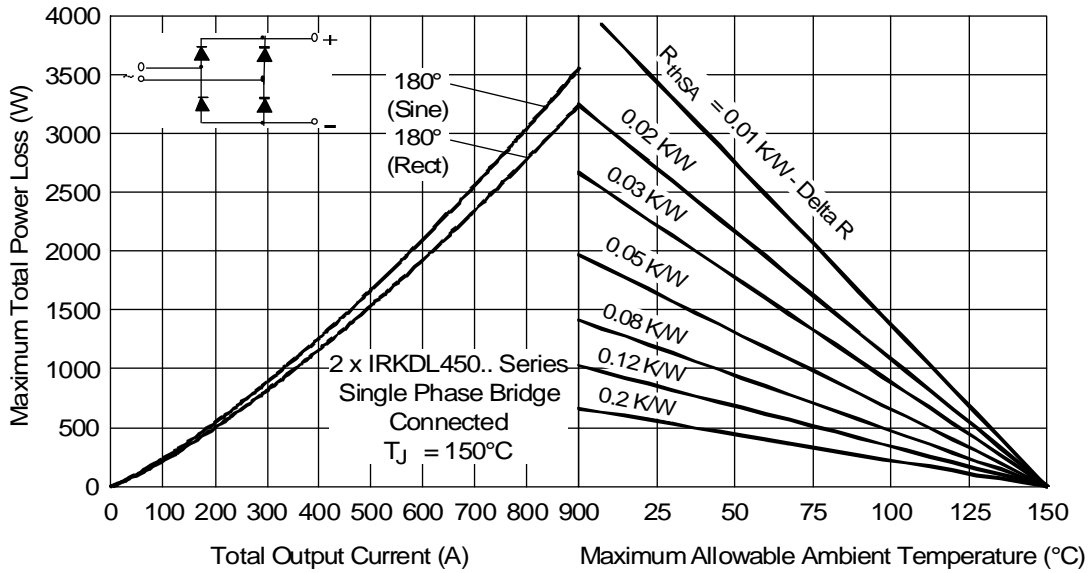

Fig. 8 - Forward Power Loss Characteristics

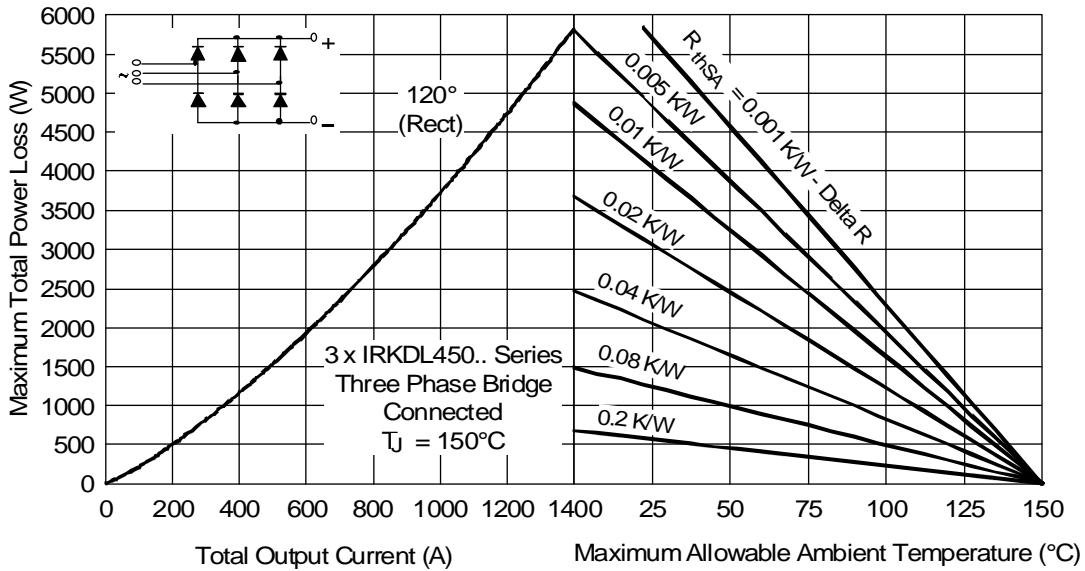

Fig. 9 - Forward Power Loss Characteristics

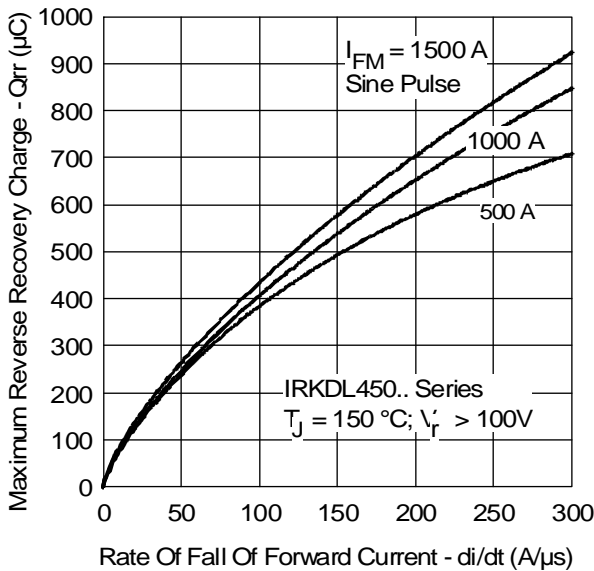

Fig. 10 - Forward Voltage Drop Characteristics

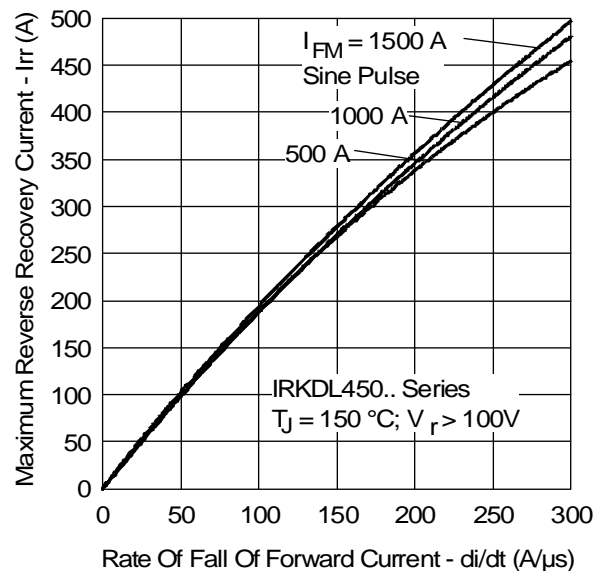

Fig. 11 - Thermal Impedance  $Z_{thJC}$  Characteristic

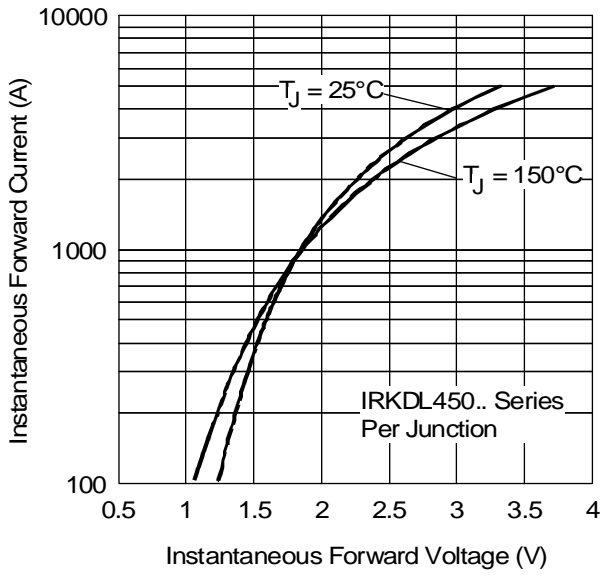

Fig. 12 - Forward Voltage Drop Characteristics

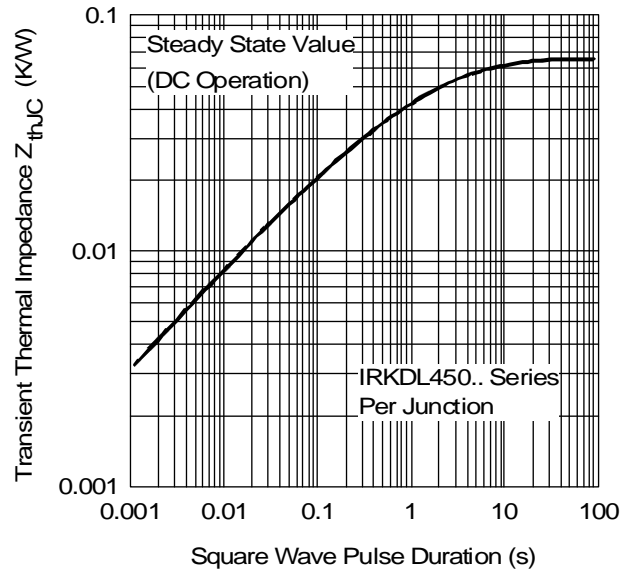

Fig. 13 - Thermal Impedance  $Z_{thJC}$  Characteristic



LittleDiode supplies new, hard to find or obsolete electronic components and semiconductors all over the world.

With over two million different components listed you are sure to find the part you need.

Feel free to visit us today at our online store:

[LittleDiode.com](http://LittleDiode.com)

Looking forward to providing you with the best possible service.