



HD1750FX

HIGH VOLTAGE NPN POWER TRANSISTOR FOR HIGH DEFINITION AND NEW SUPER-SLIM CRT DISPLAYS

- STATE-OF-THE-ART TECHNOLOGY: DIFFUSED COLLECTOR "ENHANCED GENERATION" EHVS1
- WIDER RANGE OF OPTIMUM DRIVE CONDITIONS
- LESS SENSITIVE TO OPERATING TEMPERATURE VARIATION
- FULLY INSULATED POWER PACKAGE U.L. COMPLIANT

APPLICATIONS

- HORIZONTAL DEFLECTION OUTPUT FOR DIGITAL TV, HDTV AND HIGH-END MONITORS

DESCRIPTION

The device is manufactured using Diffused Collector in Planar technology adopting "Enhance High Voltage Structure" (EHVS1) developed to fit High-Definition CRT displays.

The new HD product series show improved silicon efficiency bringing updated performance to the Horizontal Deflection stage.

Figure 1: Package

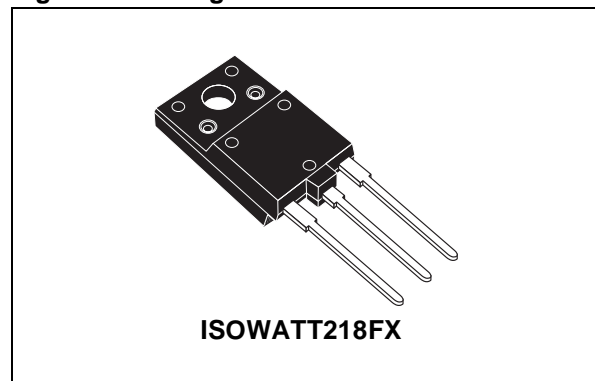

Figure 2: Internal Schematic Diagram

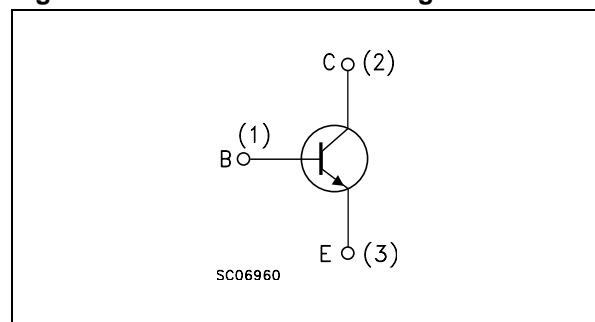

Table 1: Order Codes

Part Number	Marking	Package	Packaging
HD1750FX	HD1750FX	ISOWATT218FX	TUBE

HD1750FX

Table 2: Absolute Maximum Ratings

Symbol	Parameter	Value	Unit
V_{CES}	Collector-Emitter Voltage ($V_{BE} = 0$)	1700	V
V_{CEO}	Collector-Emitter Voltage ($I_B = 0$)	800	V
V_{EBO}	Emitter-Base Voltage ($I_C = 0$)	10	V
I_C	Collector Current	24	A
I_{CM}	Collector Peak Current ($t_p < 5\text{ms}$)	36	A
I_B	Base Current	12	A
I_{BM}	Base Peak Current ($t_p < 5\text{ms}$)	18	A
P_{tot}	Total Dissipation at $T_C = 25\text{ }^\circ\text{C}$	75	W
V_{ins}	Insulation Withstand Voltage (RMS) from All Three Leads to External Heatsink	2500	V
T_{stg}	Storage Temperature	-65 to 150	$^\circ\text{C}$
T_J	Max. Operating Junction Temperature	150	$^\circ\text{C}$

Table 3: Thermal Data

$R_{thj-case}$	Thermal Resistance Junction-Case	Max	1.67	$^\circ\text{C/W}$
----------------	----------------------------------	-----	------	--------------------

Table 4: Electrical Characteristics ($T_{case} = 25\text{ }^\circ\text{C}$ unless otherwise specified)

Symbol	Parameter	Test Conditions	Min.	Typ.	Max.	Unit
I_{CES}	Collector Cut-off Current ($V_{BE} = 0$)	$V_{CE} = 1700\text{ V}$ $V_{CE} = 1700\text{ V}$ $T_C = 125\text{ }^\circ\text{C}$			0.2 2	mA mA
I_{EBO}	Emitter Cut-off Current ($I_C = 0$)	$V_{EB} = 5\text{ V}$			10	μA
$V_{CEO(sus)}^*$	Collector-Emitter Sustaining Voltage ($I_B = 0$)	$I_C = 10\text{ mA}$	800			V
V_{EBO}	Emitter-Base Voltage ($I_C = 0$)	$I_E = 10\text{ mA}$	10			V
$V_{CE(sat)}^*$	Collector-Emitter Saturation Voltage	$I_C = 12\text{ A}$ $I_B = 3\text{ A}$			3	V
$V_{BE(sat)}^*$	Base-Emitter Saturation Voltage	$I_C = 12\text{ A}$ $I_B = 3\text{ A}$		0.95	1.5	V
h_{FE}	DC Current Gain	$I_C = 1\text{ A}$ $V_{CE} = 5\text{ V}$ $I_C = 12\text{ A}$ $V_{CE} = 5\text{ V}$	6.5	30	9.5	
t_s t_f	INDUCTIVE LOAD Storage Time Fall Time	$I_C = 12\text{ A}$ $f_h = 31250\text{ Hz}$ $I_{B(on)} = 1.9\text{ A}$ $I_{B(off)} = -8.1\text{ A}$ $V_{CE(fly)} = 1320\text{ V}$ $V_{BE(off)} = -2.7\text{ V}$ $L_{BB(off)} = 0.8\text{ }\mu\text{H}$		3.1 350	3.8 500	μs ns
t_s t_f	INDUCTIVE LOAD Storage Time Fall Time	$I_C = 6.5\text{ A}$ $f_h = 100\text{ kHz}$ $I_{B(on)} = 1.2\text{ A}$ $I_{B(off)} = -5.85\text{ A}$ $V_{CE(fly)} = 1220\text{ V}$ $V_{BE(off)} = -2.7\text{ V}$ $L_{BB(off)} = 0.25\text{ }\mu\text{H}$		1.7 180	2 250	μs ns

* Pulsed: Pulsed duration = 300 μs , duty cycle $\leq 1.5\%$.

Figure 3: Safe Operating Area

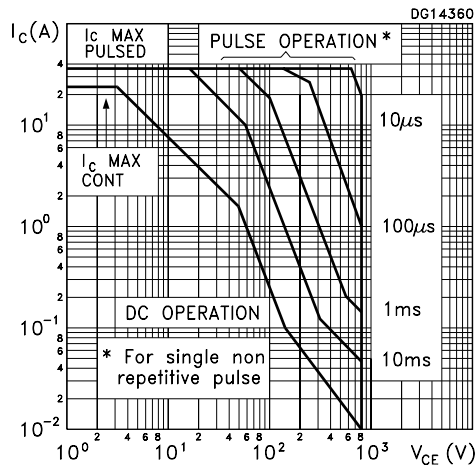

Figure 4: Output Characteristics

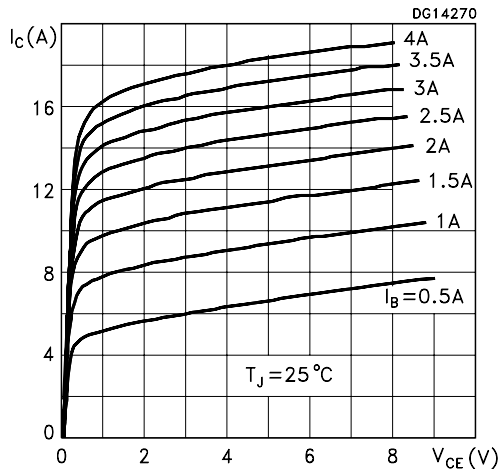

Figure 5: DC Current Gain

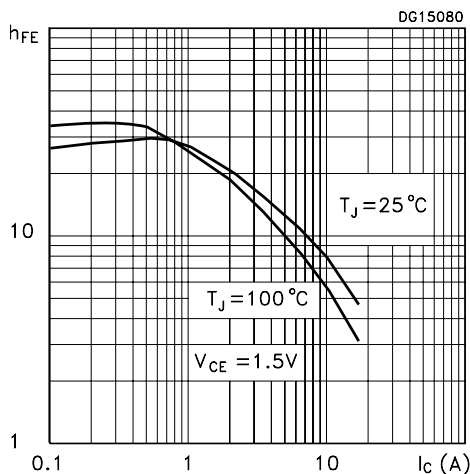

Figure 6: Derating Curve

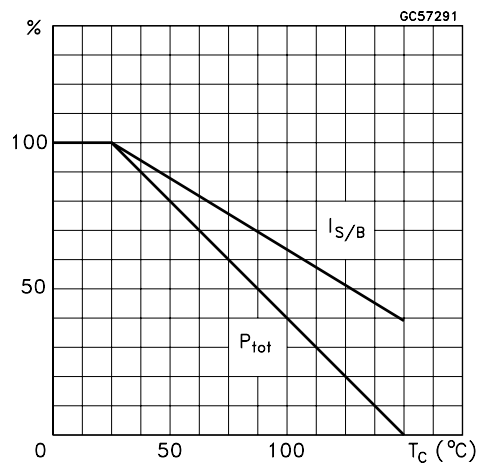

Figure 7: Reverse Biased SOA

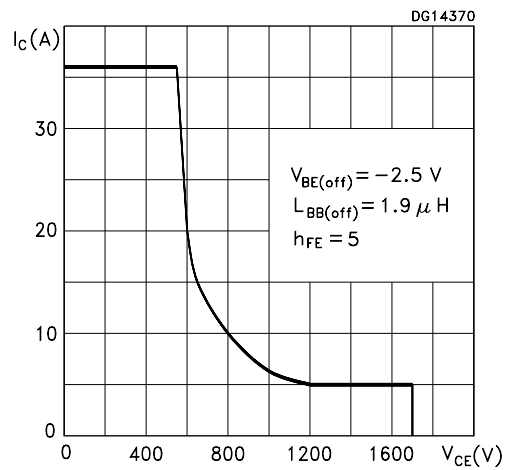

Figure 8: DC Current Gain

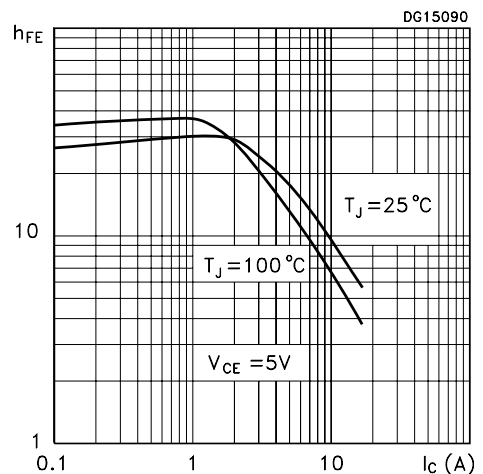

Figure 9: Collector-Emitter Saturation Voltage

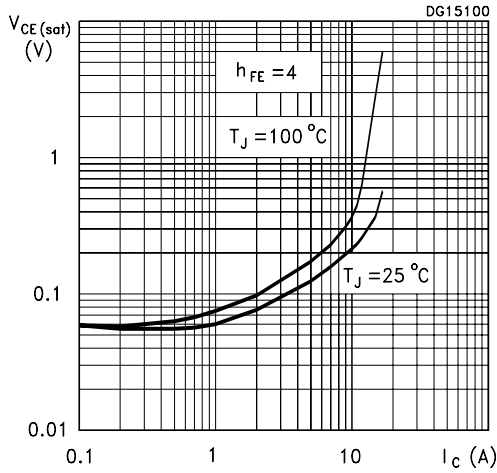

Figure 10: Power Losses

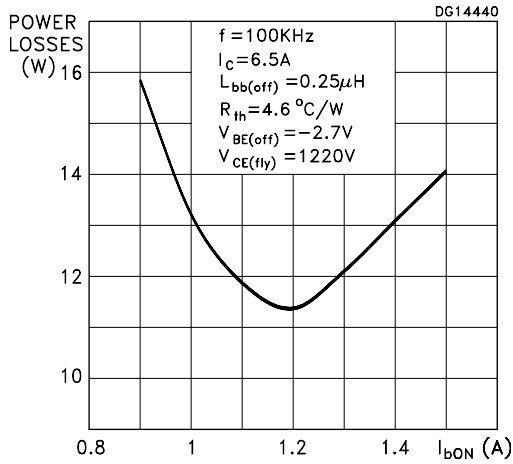

Figure 11: Inductive Load Switching Time

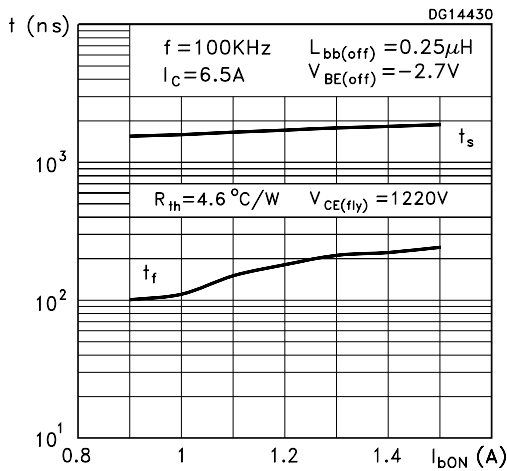

Figure 12: Base-Emitter Saturation Voltage

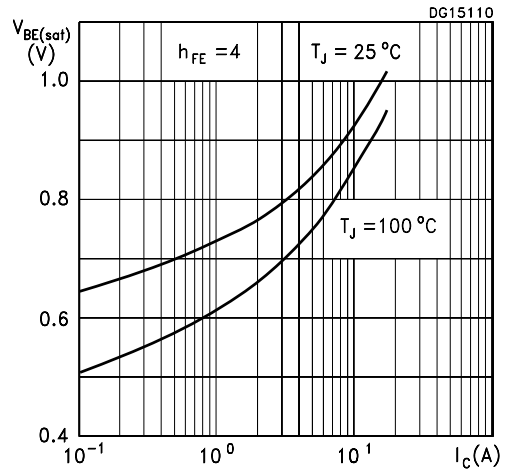

Figure 13: Power Losses

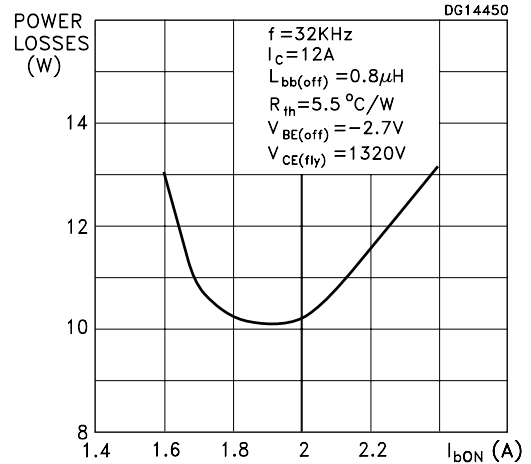

Figure 14: Inductive Load Switching Time

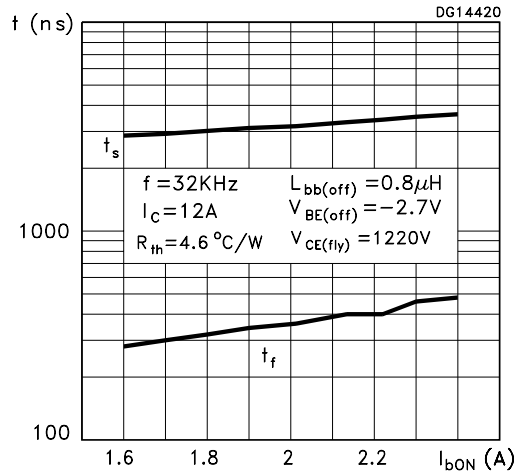

Figure 15: Power Losses and Inductive Load Switching Test Circuit

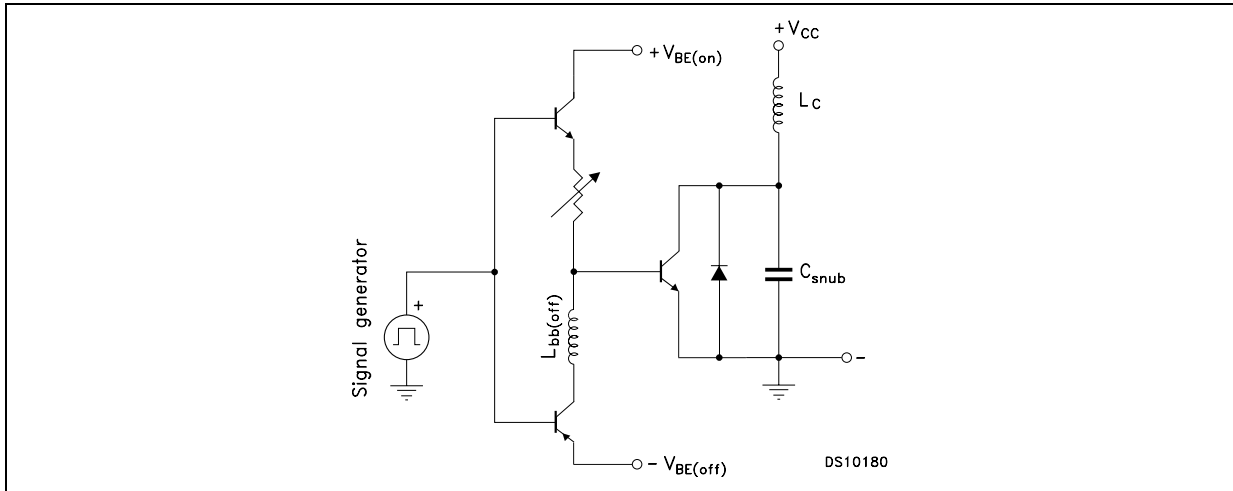

Figure 16: Reverse Biased Safe Operating Area Test Circuit

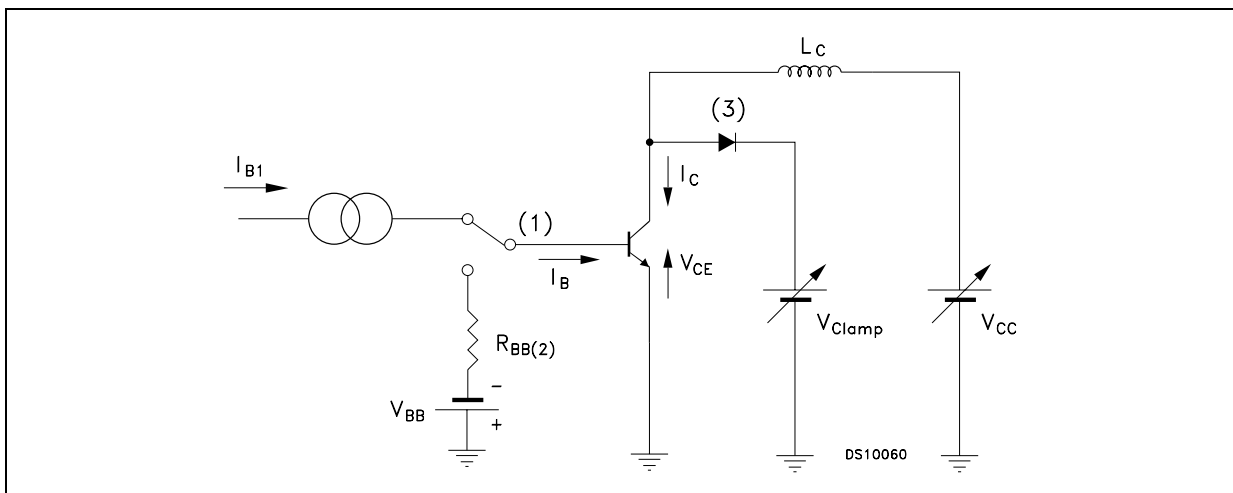

Figure 5: Revision History

Release Date	Version	Change Designator
30-May-2005	1	Initial Release.
19-Dec-2005	2	New h_{FE} value in table 4

Information furnished is believed to be accurate and reliable. However, STMicroelectronics assumes no responsibility for the consequences of use of such information nor for any infringement of patents or other rights of third parties which may result from its use. No license is granted by implication or otherwise under any patent or patent rights of STMicroelectronics. Specifications mentioned in this publication are subject to change without notice. This publication supersedes and replaces all information previously supplied. STMicroelectronics products are not authorized for use as critical components in life support devices or systems without express written approval of STMicroelectronics.

The ST logo is a registered trademark of STMicroelectronics
All other names are the property of their respective owners

© 2005 STMicroelectronics - All Rights Reserved

STMicroelectronics group of companies

Australia - Belgium - Brazil - Canada - China - Czech Republic - Finland - France - Germany - Hong Kong - India - Israel - Italy - Japan -
Malaysia - Malta - Morocco - Singapore - Spain - Sweden - Switzerland - United Kingdom - United States of America

www.st.com



LittleDiode supplies new, hard to find or obsolete electronic components and semiconductors all over the world.

With over two million different components listed you are sure to find the part you need.

Feel free to visit us today at our online store:

LittleDiode.com

Looking forward to providing you with the best possible service.