

Major Ratings and Characteristics

Characteristics	31DQ..	Units
$I_{F(AV)}$ Rectangular waveform	3.3	A
V_{RRM}	90/100	V
I_{FSM} @ $t_p = 5 \mu s$ sine	210	A
V_F @3Apk, $T_J = 25^\circ C$	0.85	V
T_J	-40 to 150	$^\circ C$

Description/ Features

The 31DQ.. axial leaded Schottky rectifier has been optimized for very low forward voltage drop, with moderate leakage. Typical applications are in switching power supplies, converters, free-wheeling diodes, and reverse battery protection.

- Low profile, axial leaded outline
- High purity, high temperature epoxy encapsulation for enhanced mechanical strength and moisture resistance
- Very low forward voltage drop
- High frequency operation
- Guard ring for enhanced ruggedness and long term reliability

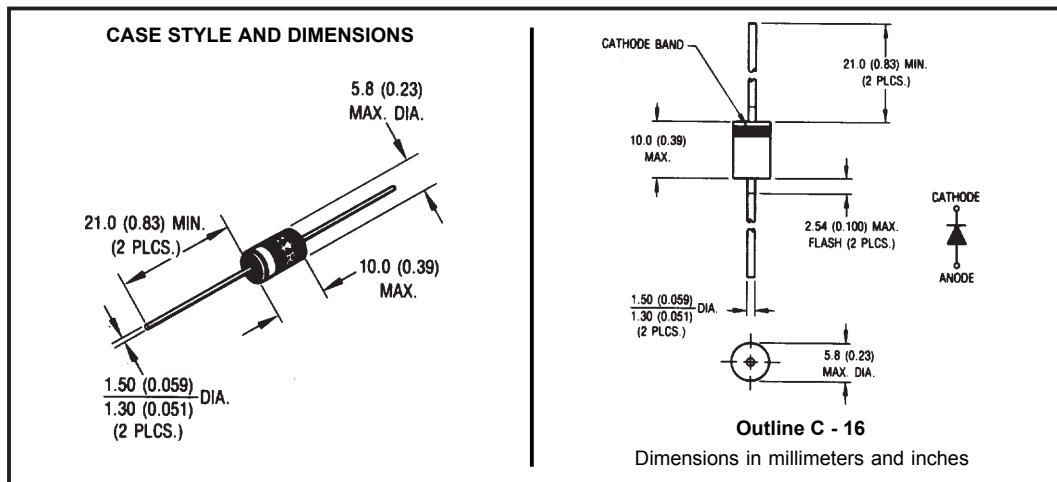

Voltage Ratings

Part number	31DQ09	31DQ10
V_R Max. DC Reverse Voltage (V)	90	100
V_{RWM} Max. Working Peak Reverse Voltage (V)		

Absolute Maximum Ratings

Parameters	31DQ..	Units	Conditions
$I_{F(AV)}$ Max. Average Forward Current * See Fig. 4	3.3	A	50% duty cycle @ $T_C = 53.4^\circ\text{C}$, rectangular wave form
I_{FSM} Max. Peak One Cycle Non-Repetitive Surge Current * See Fig. 6	210	A	Following any rated load condition and with rated V_{RRM} applied
	34		
E_{AS} Non-Repetitive Avalanche Energy	3.0	mJ	$T_J = 25^\circ\text{C}$, $I_{AS} = 1.0$ Amps, $L = 6$ mH
I_{AR} Repetitive Avalanche Current	0.5	A	Current decaying linearly to zero in 1 μsec Frequency limited by T_J max. $V_A = 1.5 \times V_R$ typical

Electrical Specifications

Parameters	31DQ..	Units	Conditions
V_{FM} Max. Forward Voltage Drop * See Fig. 1 (1)	0.85	V	@ 3A
	0.97	V	@ 6A
	0.69	V	@ 3A
	0.80	V	@ 6A
I_{RM} Max. Reverse Leakage Current * See Fig. 2 (1)	1	mA	$T_J = 25^\circ\text{C}$
	3	mA	$T_J = 125^\circ\text{C}$
C_T Typical Junction Capacitance	110	pF	$V_R = 5V_{DC}$ (test signal range 100Khz to 1Mhz) 25°C
L_S Typical Series Inductance	9.0	nH	Measured lead to lead 5mm from package body
dv/dt Max. Voltage Rate of Change	10000	V/ μs	(Rated V_R)

(1) Pulse Width < 300 μs , Duty Cycle <2%

Thermal-Mechanical Specifications

Parameters	31DQ..	Units	Conditions
T_J Max. Junction Temperature Range	-40 to 150	$^\circ\text{C}$	
T_{stg} Max. Storage Temperature Range	-40 to 150	$^\circ\text{C}$	
R_{thJA} Max. Thermal Resistance Junction to Ambient	80	$^\circ\text{C}/\text{W}$	DC operation Without cooling fins
R_{thJL} Typical Thermal Resistance Junction to Lead	34	$^\circ\text{C}/\text{W}$	DC operation
wt Approximate Weight	1.2 (0.042)	g (oz.)	
Case Style	C - 16		

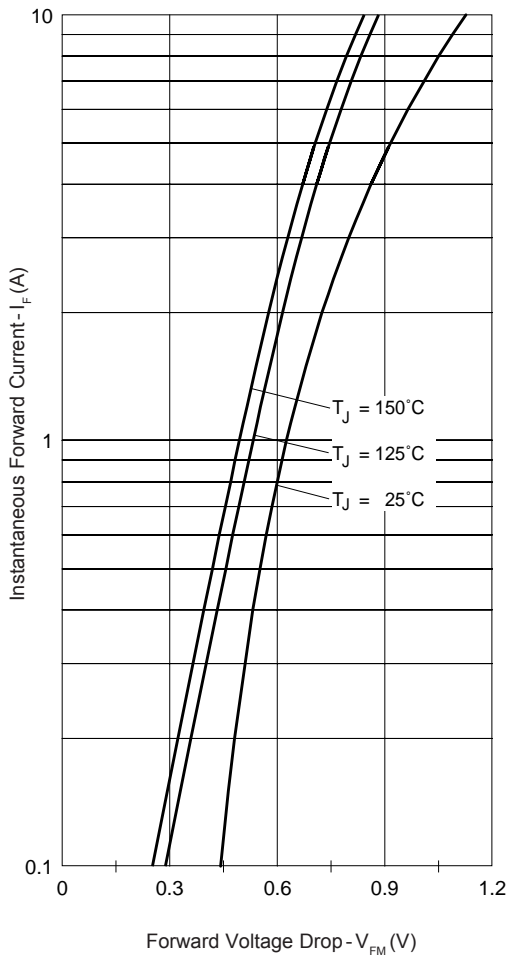

Fig. 1 - Max. Forward Voltage Drop Characteristics

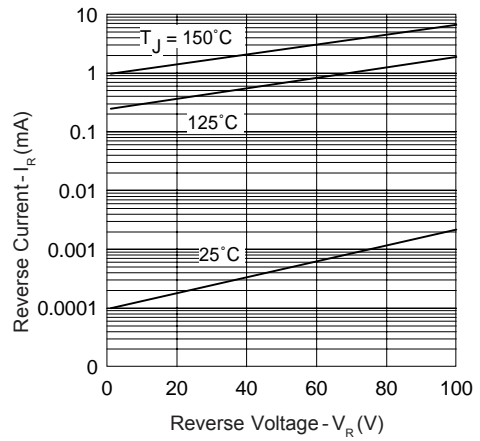

Fig. 2 - Typical Values Of Reverse Current Vs. Reverse Voltage

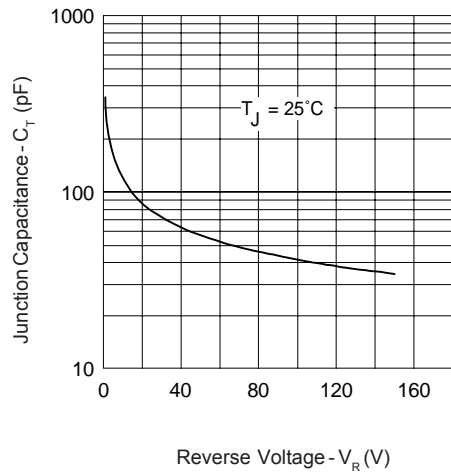

Fig. 3 - Typical Junction Capacitance Vs. Reverse Voltage

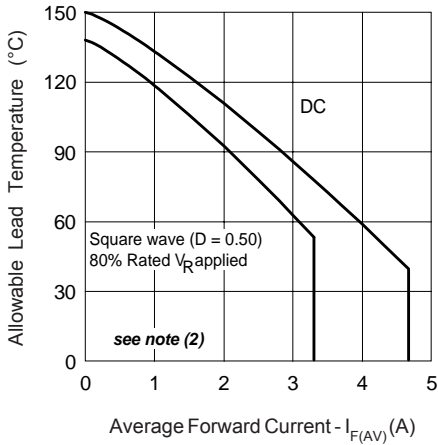

Fig. 4 - Max. Allowable Lead Temperature Vs. Average Forward Current

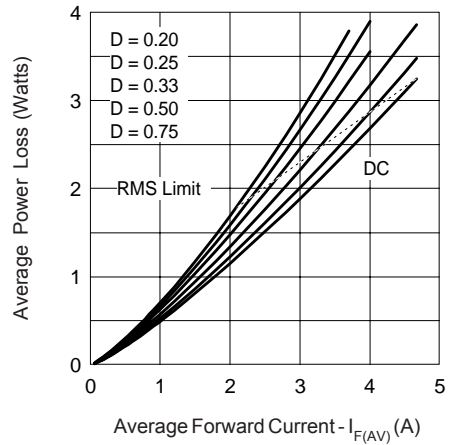

Fig. 5 - Forward Power Loss Characteristics

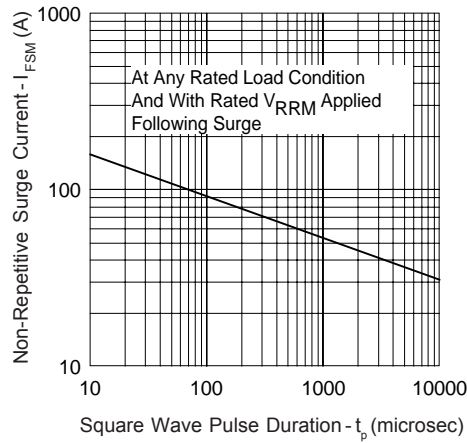

Fig. 6 - Max. Non-Repetitive Surge Current

(2) Formula used: $T_C = T_J - (P_d + P_{d_{REV}}) \times R_{thJC}$;
 $P_d = \text{Forward Power Loss} = I_{F(AV)} \times V_{FM} @ (I_{F(AV)} / D)$ (see Fig. 6);
 $P_{d_{REV}} = \text{Inverse Power Loss} = V_{R1} \times I_R (1 - D)$; $I_R @ V_{R1} = 80\% \text{ rated } V_R$

Ordering Information Table

Device Code											
	<table border="1" style="display: inline-table; border-collapse: collapse;"> <tr> <td style="padding: 5px;">31</td> <td style="padding: 5px;">D</td> <td style="padding: 5px;">Q</td> <td style="padding: 5px;">10</td> <td style="padding: 5px;">TR</td> </tr> <tr> <td style="text-align: center;">①</td> <td style="text-align: center;">②</td> <td style="text-align: center;">③</td> <td style="text-align: center;">④</td> <td style="text-align: center;">⑤</td> </tr> </table>	31	D	Q	10	TR	①	②	③	④	⑤
31	D	Q	10	TR							
①	②	③	④	⑤							
1	- 31 = 3.3A (Axial and small packages - Current is x10)										
2	- D = DO-41 package										
3	- Q = Schottky Q.. Series										
4	- 10 = Voltage Ratings										
5	- TR= Tape & Reel package (1200 pcs)										
	- = Box package (500 pcs)										

10 = 100V
 09 = 90V

```

31DQ10
*****
* SPICE Model Diode *
*****
.SUBCKT 31DQ10 ANO CAT
D1 ANO 1 CAT
*Define diode model
.MODEL DMOD D(Is=56.46E-06 N=2.202 Rs=28.27E-03 Ikf=0.5957 Xti=2 Eg=1.11
+ Cjo=199.3E-12 M=0.4572 Vj=1.873 Fc=0.5 Isr=165.6E-24 Nr=4.955
+ Bv=119.9 Ibv=215.5E-06 Tt=21.64E-09)
*****
.ENDS 31DQ10
  
```

Data and specifications subject to change without notice.
 This product has been designed and qualified for Industrial Level.
 Qualification Standards can be found on IR's Web site.



LittleDiode supplies new, hard to find or obsolete electronic components and semiconductors all over the world.

With over two million different components listed you are sure to find the part you need.

Feel free to visit us today at our online store:

LittleDiode.com

Looking forward to providing you with the best possible service.