

IGBT MODULE (S series) 600V / 50A / PIM



■ Features

- Low $V_{CE(sat)}$
- Compact package
- P.C. board mount
- Converter diode bridge, Dynamic brake circuit

■ Applications

- Inverter for motor drive
- AC and DC servo drive amplifier
- Uninterruptible power supply

■ Maximum ratings and characteristics

● Absolute maximum ratings ($T_c=25^{\circ}\text{C}$ unless without specified)

Item	Symbol	Condition	Rating	Unit	
Inverter	Collector-Emitter voltage	V_{CES}	600	V	
	Gate-Emitter voltage	V_{GES}	± 20	V	
	Collector current	I_C	Continuous	50	A
		I_{CP}	1ms	100	A
		$-I_C$		50	A
Collector power dissipation	P_C	1 device	200	W	
Brake	Collector-Emitter voltage	V_{CES}	600	V	
	Gate-Emitter voltage	V_{GES}	± 20	V	
	Collector current	I_C	Continuous	30	A
		I_{CP}	1ms	60	A
	Collector power dissipation	P_C	1 device	120	W
Converter	Repetitive peak reverse voltage	V_{RRM}	600	V	
	Repetitive peak reverse voltage	V_{RRM}	800	V	
	Average output current	I_O	50Hz/60Hz sine wave	50	A
	Surge current (Non-Repetitive)	I_{FSM}	$T_j=150^{\circ}\text{C}$, 10ms	350	A
	I^2t (Non-Repetitive)	I^2t	half sine wave	613	A^2s
Operating junction temperature	T_j		+150	$^{\circ}\text{C}$	
Storage temperature	T_{stg}		-40 to +125	$^{\circ}\text{C}$	
Isolation between terminal and copper base *2 voltage between thermistor and others *3	V_{iso}	AC : 1 minute	AC 2500	V	
			AC 2500	V	
Mounting screw torque			3.5 *1	N·m	

*1 Recommendable value : 2.5 to 3.5 N·m (M5)

*2 All terminals should be connected together when isolation test will be done.

*3 Terminal 8 and 9 should be connected together. Terminal 1 to 7 and 10 to 24 should be connected together and shorted to copper base.

● Electrical characteristics (Tj=25°C unless otherwise specified)

Item	Symbol	Condition	Characteristics			Unit		
			Min.	Typ.	Max.			
Inverter	Zero gate voltage collector current	ICES	VCE=600V, VGE=0V		1.0	mA		
	Gate-Emitter leakage current	IGES	VCE=0V, VGE=±20V		0.2	µA		
	Gate-Emitter threshold voltage	VGE(th)	VCE=20V, Ic=50mA		5.5	7.8	8.5	V
	Collector-Emitter saturation voltage	VCE(sat)	VGE=15V, Ic=50A	chip	1.8		V	
				terminal	1.95	2.4		
	Input capacitance	Cies	VGE=0V, VCE=10V, f=1MHz		5000		pF	
	Turn-on time	ton	VCC=300V		0.45	1.2	µs	
		tr	Ic=50A		0.25	0.6		
		tr(i)	VGE=±15V		0.08			
	Turn-off	toff	RG=51Ω		0.40	1.0		
tf				0.05	0.35			
Forward on voltage	VF	IF=50A	chip	1.75		V		
			terminal	1.9	2.6			
Reverse recovery time of FRD	trr	IF=50A			0.3	µs		
Brake	Zero gate voltage collector current	ICES	VCEs=600V, VGE=0V		1.0	mA		
	Gate-Emitter leakage current	IGES	VCE=0V, VGE=±20V		0.2	µA		
	Collector-Emitter saturation voltage	VCE(sat)	Ic=30A, VGE=15V	chip	1.8		V	
				terminal	1.95	2.4		
	Turn-on time	ton	VCC=300V		0.45	1.2	µs	
		tr	Ic=30A		0.25	0.6		
	Turn-off time	toff	VGE=±15V		0.40	1.0		
		tf	RG=82Ω		0.05	0.35		
	Reverse current	Irrm	VR=600V			1.0	mA	
	Converter	Forward on voltage	VFM	IF=50A	chip	1.1	V	
terminal					1.2	1.5		
Reverse current	Irrm	VR=800V			1.0	mA		
Thermistor	Resistance	R	T=25°C		5000	Ω		
			T=100°C		465		495	520
	B value	B	T=25/50°C		3305	3375	3450	K

● Thermal resistance Characteristics

Item	Symbol	Condition	Characteristics			Unit
			Min.	Typ.	Max.	
Thermal resistance (1 device)	Rth(j-c)	Inverter IGBT			0.63	°C/W
		Inverter FWD			1.33	
		Brake IGBT			1.04	
		Converter Diode			0.90	
Contact thermal resistance *	Rth(c-f)	With thermal compound		0.05		

* This is the value which is defined mounting on the additional cooling fin with thermal compound

■ Equivalent Circuit Schematic

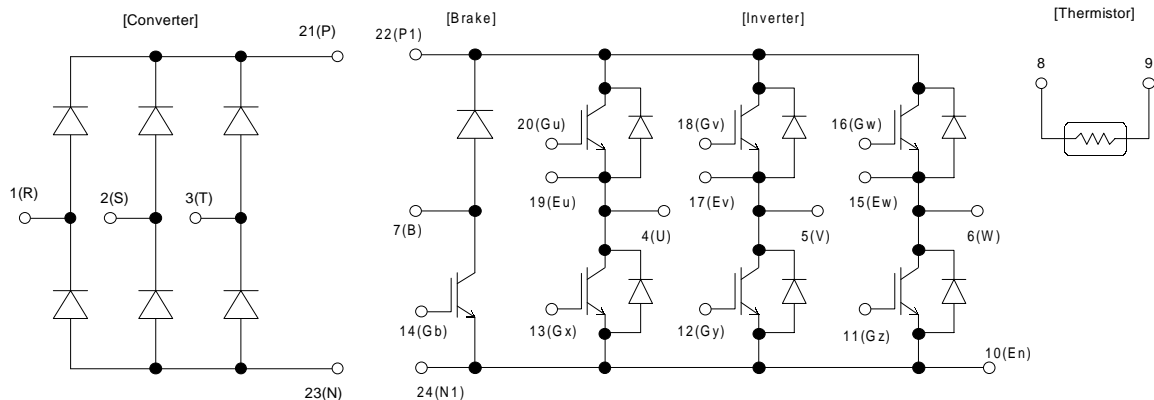

Characteristics (Representative)

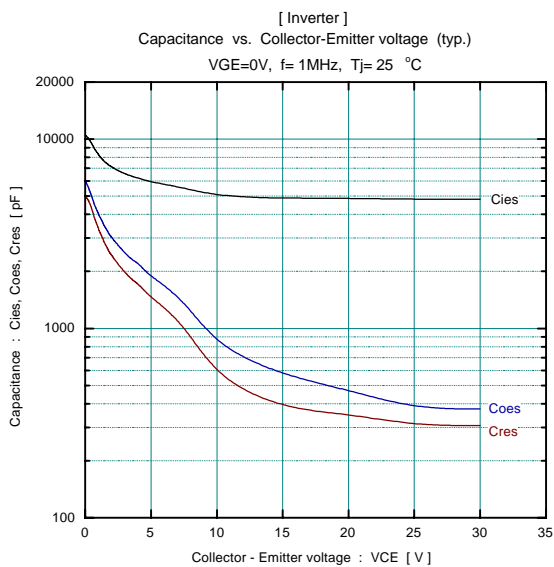
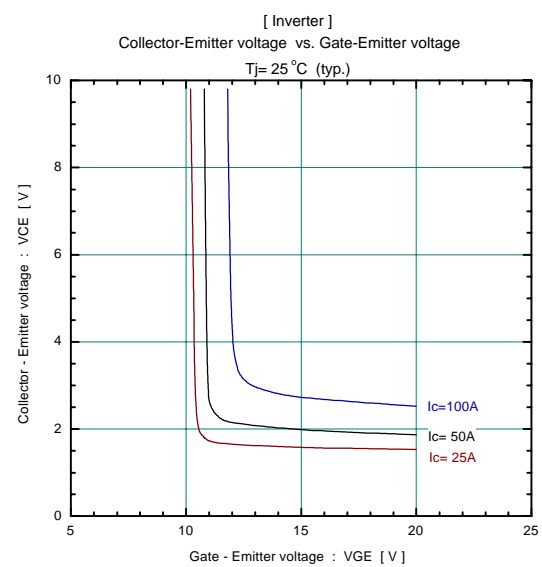
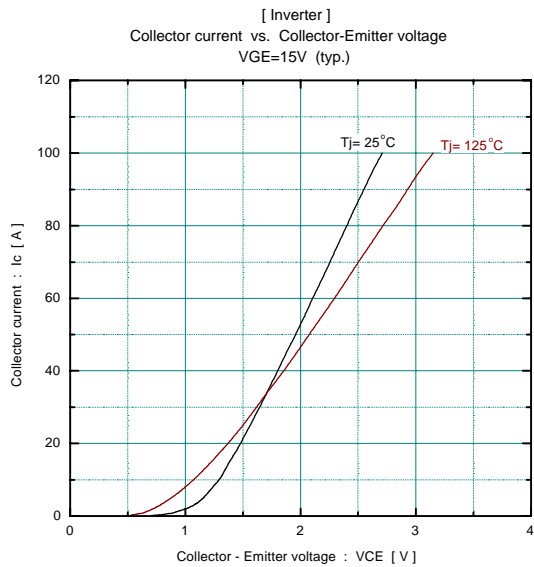
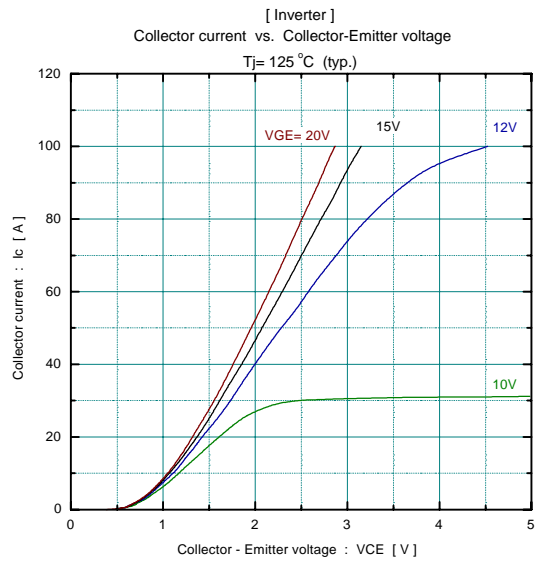
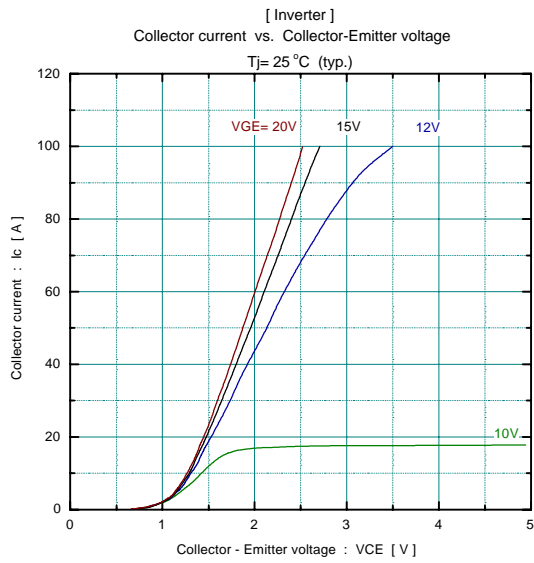

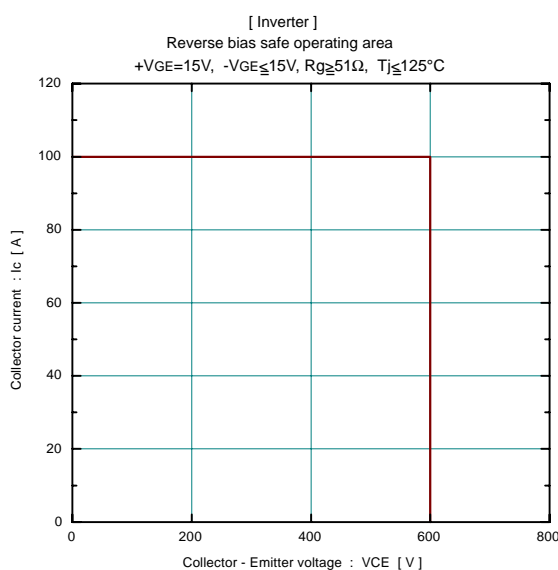
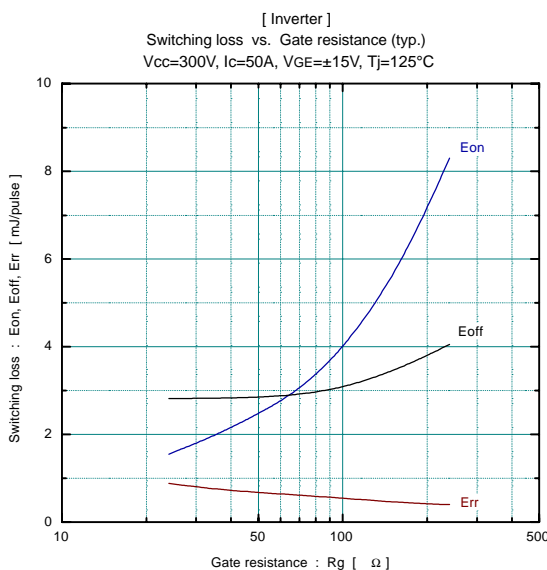
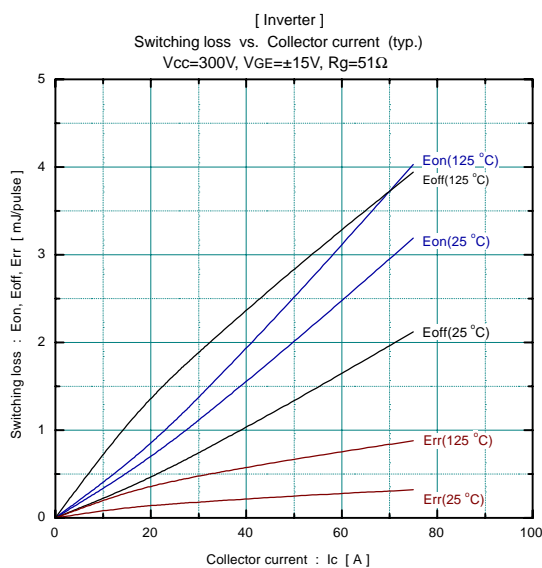
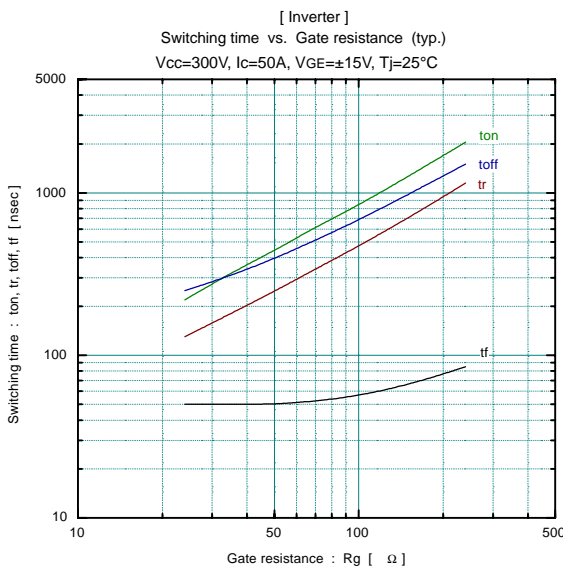
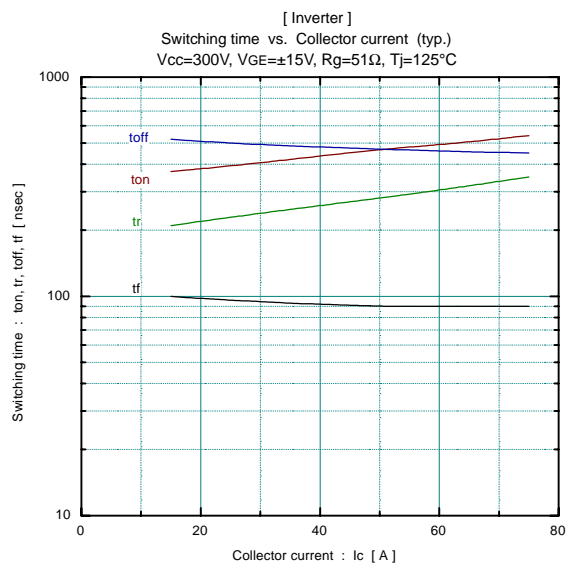
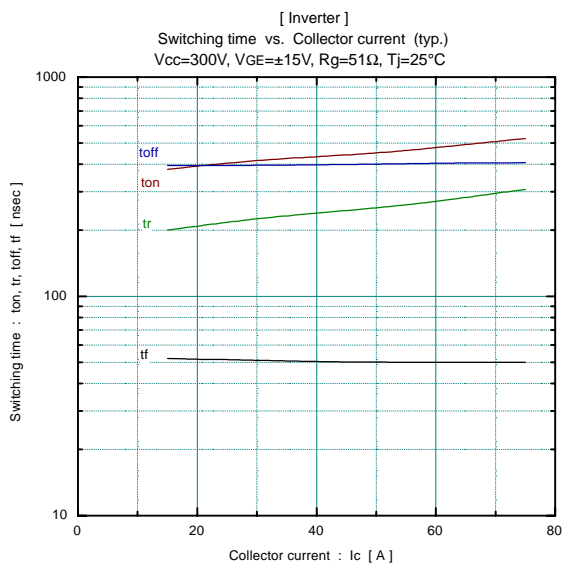

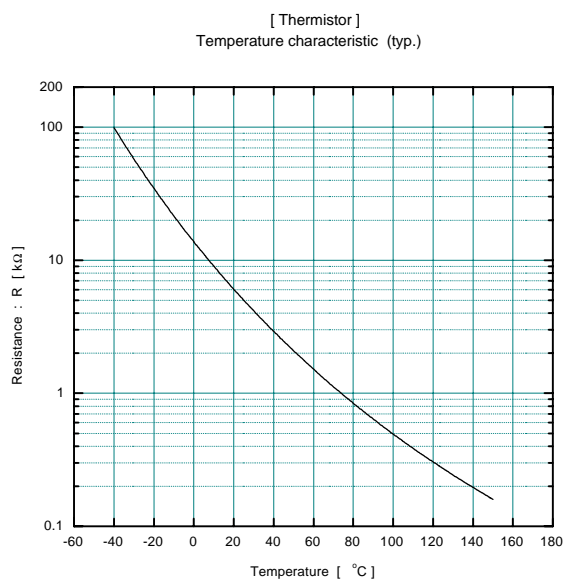
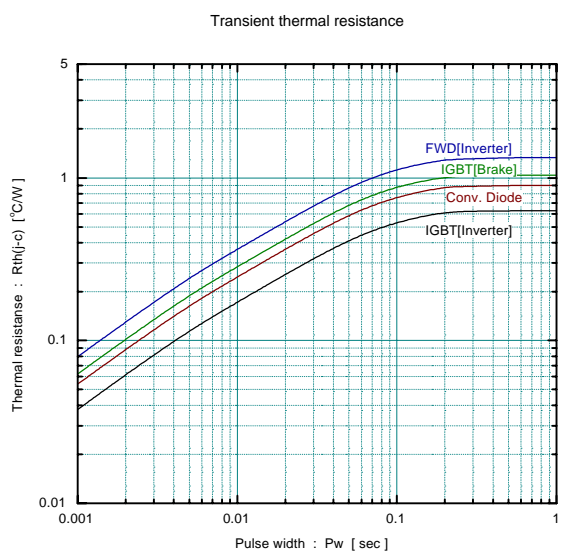
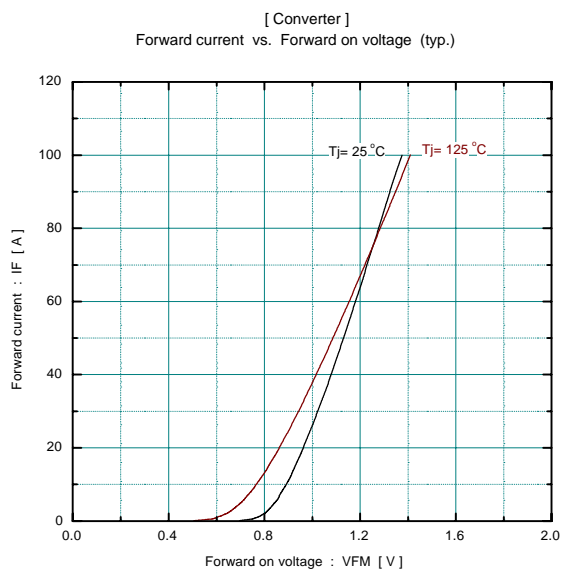
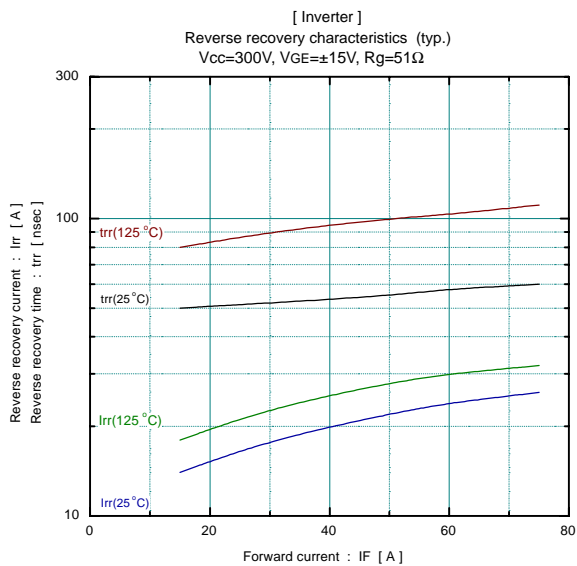
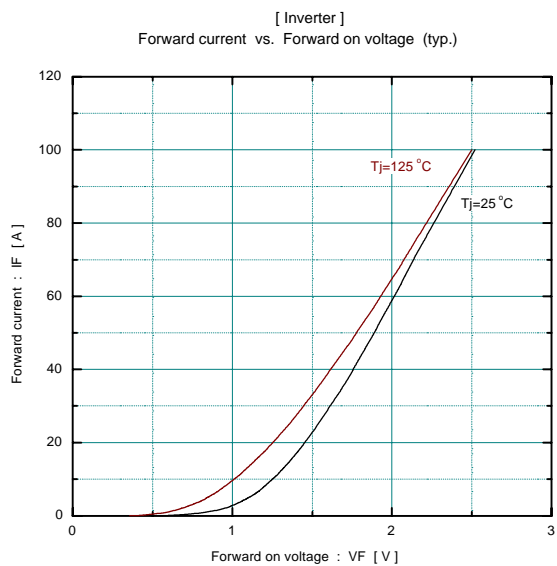

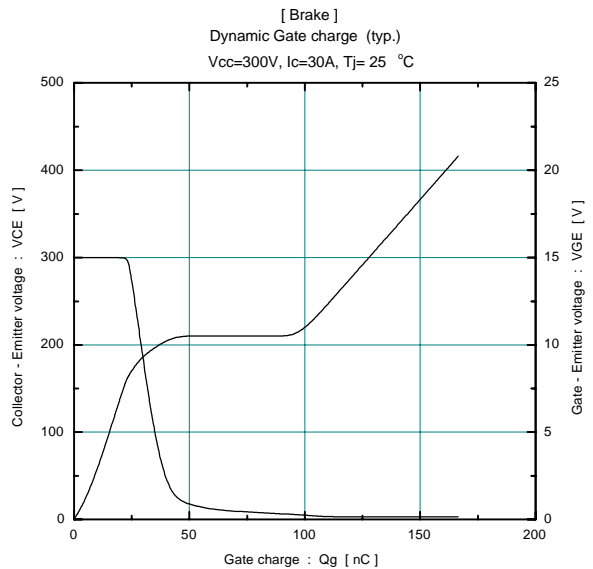
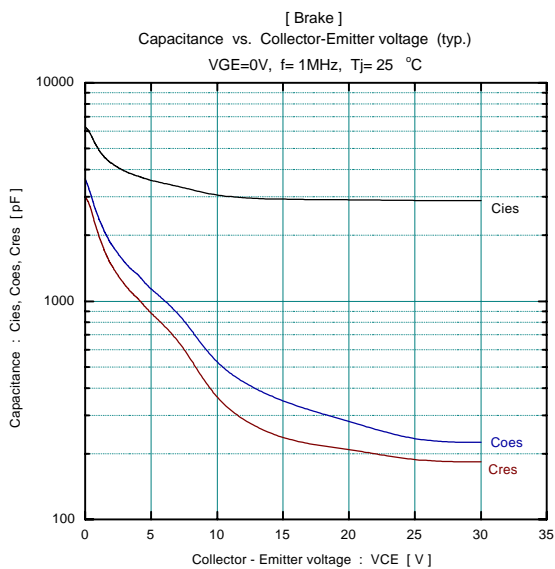
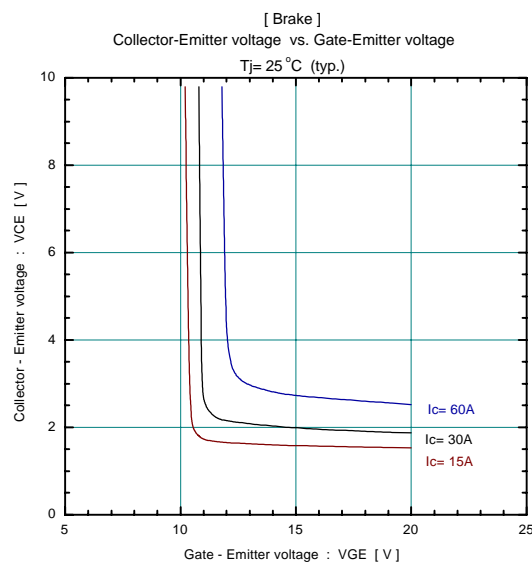
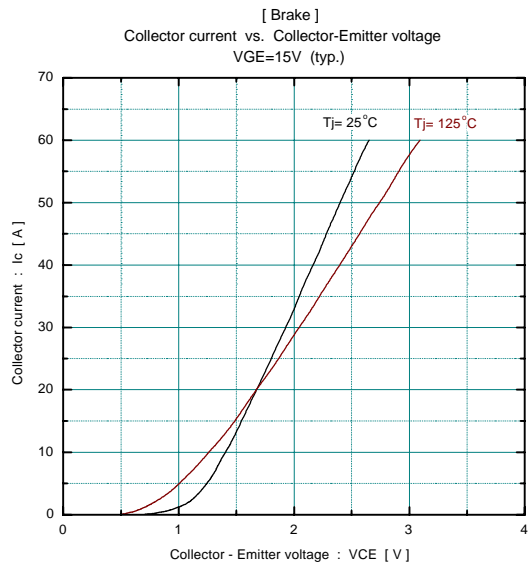
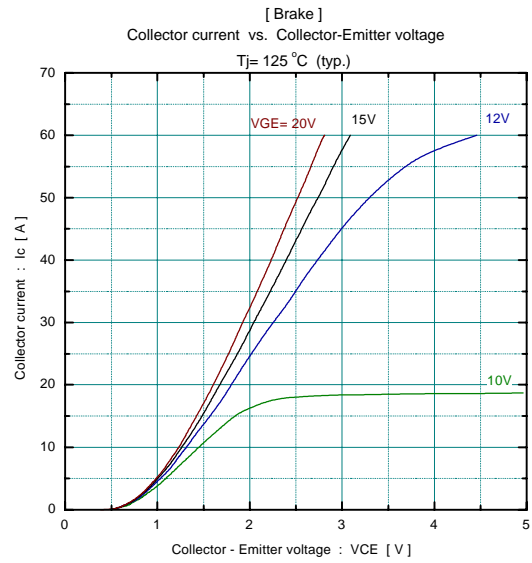
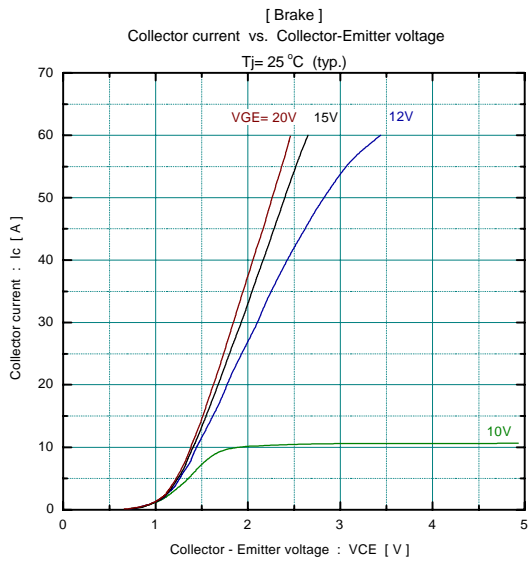

■ Outline Drawings, mm

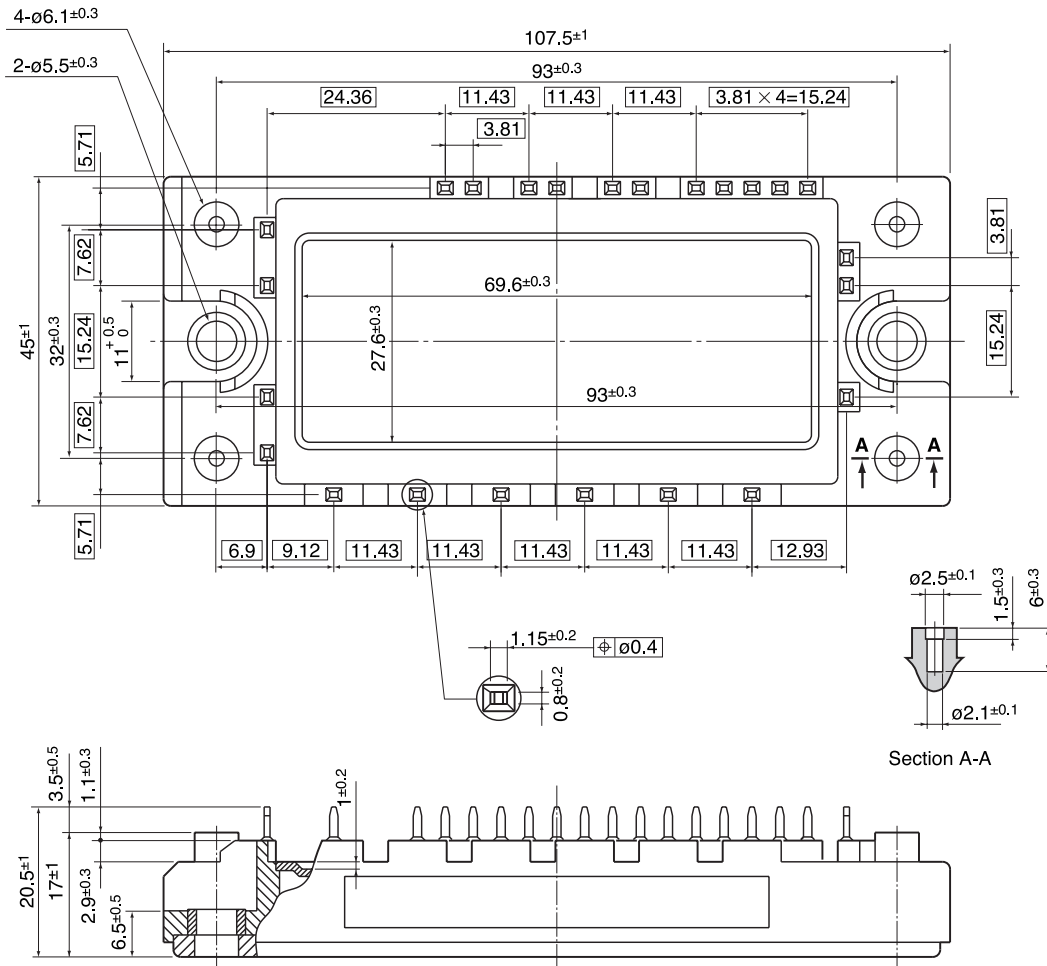

□ Shows theory dimensions



LittleDiode supplies new, hard to find or obsolete electronic components and semiconductors all over the world.

With over two million different components listed you are sure to find the part you need.

Feel free to visit us today at our online store:

LittleDiode.com

Looking forward to providing you with the best possible service.