

HMC438MS8G

SMT GaAs HBT MMIC DIVIDE-BY-5, DC - 7.0 GHz

Typical Applications

Prescaler for DC to C Band PLL Applications:

- UNII, Pt. - Pt. & VSAT Radios
- 802.11a & HiperLAN WLAN
- Fiber Optic
- Cellular / 3G Infrastructure

Features

- SSB Phase Noise: -153 dBc/Hz @ 100KHz
- Wide Bandwidth
- Output Power: -1 dBm
- Single DC Supply: +5V @ 80 mA
- MS8G SMT Package

Functional Diagram

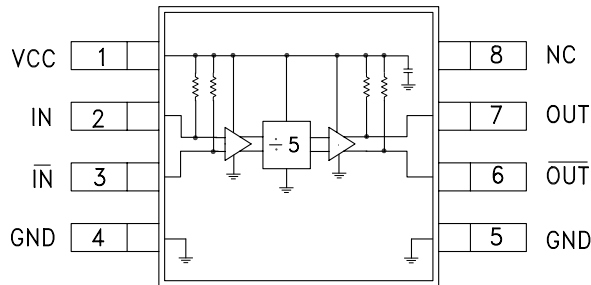

General Description

The HMC438MS8G is a low noise Divide-by-5 Static Divider utilizing InGaP GaAs HBT technology in a low cost 8 lead surface mount plastic package. This device operates from DC (with a square wave input) to 7.0 GHz input frequency from a single +5.0V DC supply. The low additive SSB phase noise of -153 dBc/Hz at 100 kHz offset helps the user maintain good system noise performance.

Electrical Specifications, $T_A = +25^\circ C$, 50 Ohm System, $V_{cc} = 5V$

Parameter	Conditions	Min.	Typ.	Max.	Units
Maximum Input Frequency		7.0	7.5		GHz
Minimum Input Frequency	Sine Wave Input [1]		0.1		GHz
Input Power Range	$F_{in} = 1$ to 5 GHz	-12	-15	+12	dBm
	$F_{in} = 5$ to 6 GHz	-12	-15	+10	dBm
	$F_{in} = 6$ to 7 GHz	-10	-15	+5	dBm
Output Power		-4	-1		dBm
Reverse Leakage	Both RF Outputs Terminated		-50		dBm
SSB Phase Noise (100 kHz offset)	$P_{in} = 0$ dBm, $F_{in} = 6$ GHz		-153		dBc/Hz
Output Transition Time	$P_{in} = 0$ dBm, $F_{out} = 882$ MHz		100		ps
Supply Current (I_{cc})			80		mA

1. Divider will operate down to DC for square-wave input signal.

Input Sensitivity Window, T= 25 °C

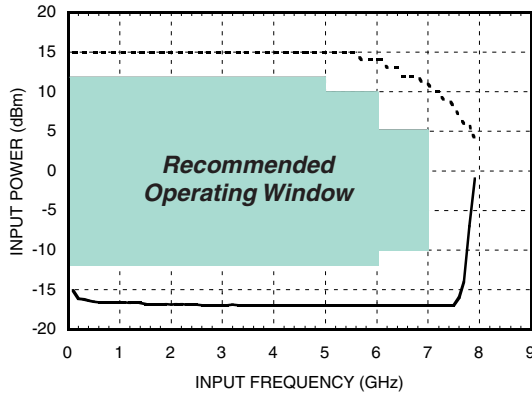

Input Sensitivity Window vs. Temperature

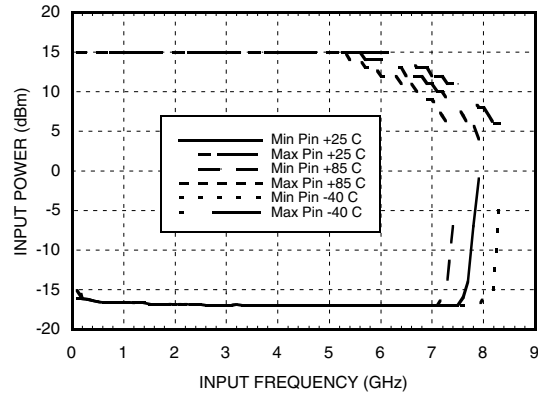

Output Power vs. Temperature

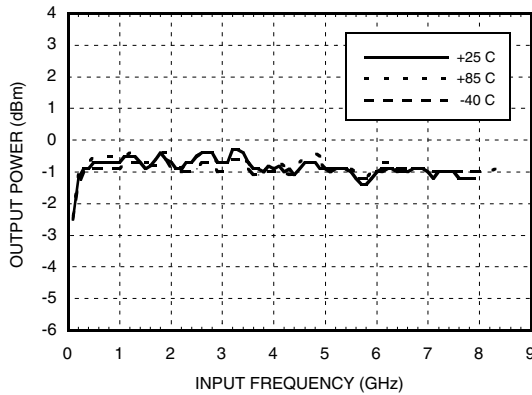

**SSB Phase Noise Performance,
Pin= 0 dBm, Fin= 6GHz, T= 25 °C**

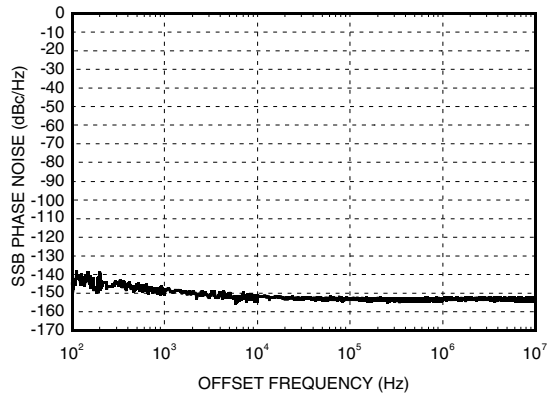

Output Harmonic Content, Pin= 0 dBm, T= 25 °C

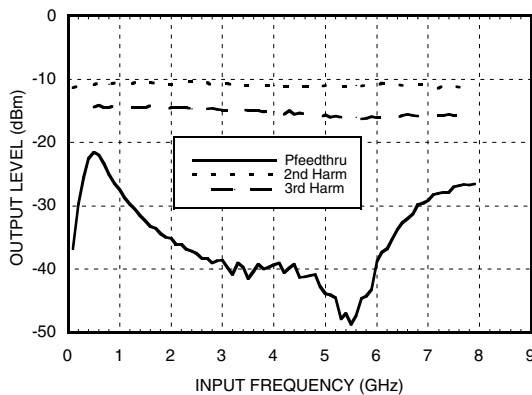

Reverse Leakage, Pin= 0 dBm, T= 25 °C

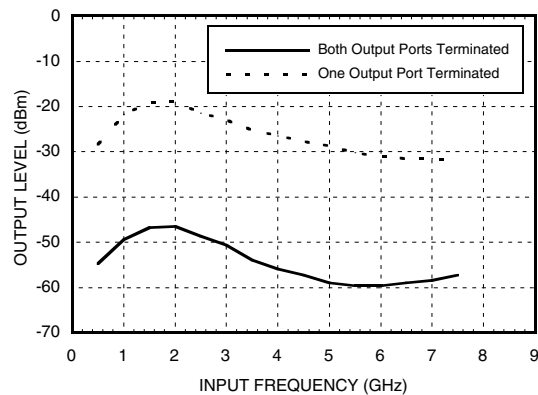

Output Voltage Waveform,
Pin= 0 dBm, Fout= 882 MHz, T= 25 °C

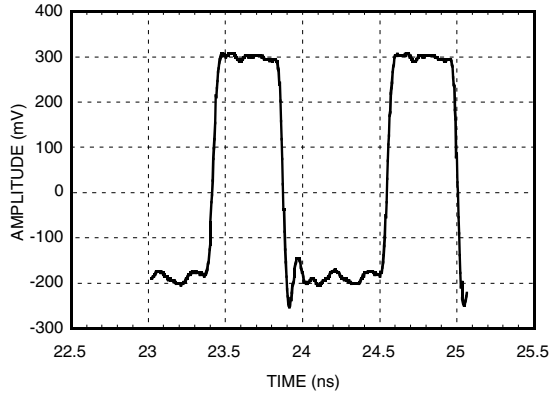

Absolute Maximum Ratings

RF Input (Vcc= +5V)	+13 dBm
Vcc	+5.5V
Maximum Channel Temperature	135 °C
Continuous P _{diss} (T=85 °C) (derate 11.3mW/°C above 92 °C)	485mW
Storage Temperature	-65 to +150 °C
Operating Temperature	-40 to +85 °C

DC blocking capacitors are required at RF input and RF output ports. Choose value for lowest frequency of operation.

Typical Supply Current vs. Vcc

Vcc (V)	Icc (mA)
4.75	75
5.0	80
5.25	87

Note: Divider will operate over full voltage range shown above

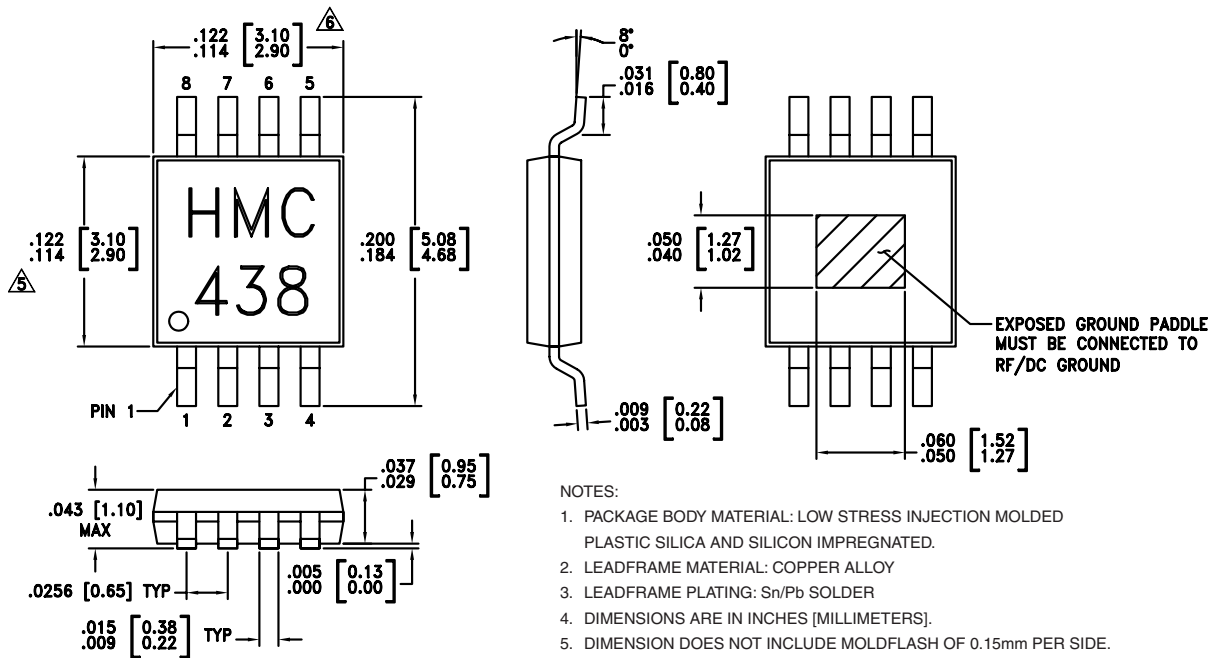

Outline Drawing



NOTES:

1. PACKAGE BODY MATERIAL: LOW STRESS INJECTION MOLDED PLASTIC SILICA AND SILICON IMPREGNATED.
2. LEADFRAME MATERIAL: COPPER ALLOY
3. LEADFRAME PLATING: Sn/Pb SOLDER
4. DIMENSIONS ARE IN INCHES [MILLIMETERS].
5. DIMENSION DOES NOT INCLUDE MOLDFLASH OF 0.15mm PER SIDE.
6. DIMENSION DOES NOT INCLUDE MOLDFLASH OF 0.25mm PER SIDE.
7. ALL GROUND LEADS AND GROUND PADDLE MUST BE SOLDERED TO PCB RF GROUND.

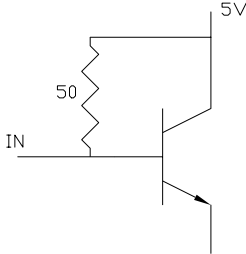
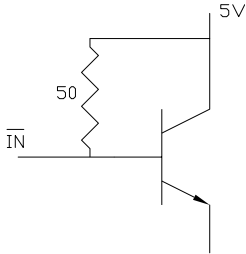
Pin Description

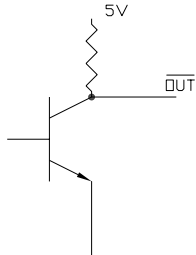
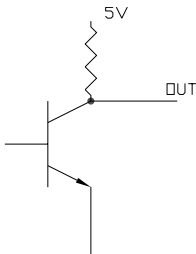
Pin Number	Function	Description	Interface Schematic
1	Vcc	Supply voltage 5V ± 0.25V.	
2	IN	RF input must be DC blocked.	
3	$\overline{\text{IN}}$	RF input 180° out of phase with pin 2 for differential operation. AC ground for single ended operation.	
4, 5	GND	All ground leads and ground paddle must be soldered to PCB RF/DC ground.	
6	$\overline{\text{OUT}}$	Divided output 180° out of phase with pin 7.	
7	OUT	Divided Output.	
8	N/C	No Connection	

Evaluation PCB

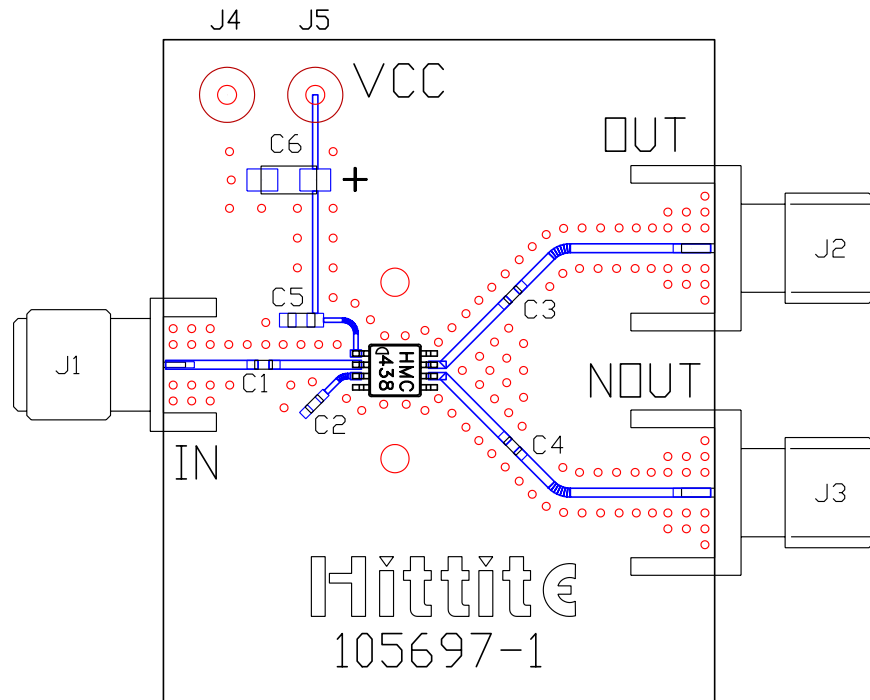

List of Materials

Item	Description
J1 - J3	PC Mount SMA RF Connector
J4, J5	DC Pin
C1 - C4	100 pF Capacitor, 0402 Pkg.
C5	10,000 pF Capacitor, 0603 Pkg.
C6	4.7 µF Tantalum Capacitor
U1	HMC438MS8G Divide-by-5
PCB*	105697 Eval Board
* Circuit Board Material: Rogers 4350	

The circuit board used in the final application should use RF circuit design techniques. Signal lines should have 50 ohm impedance while the package ground leads and backside ground slug should be connected directly to the ground plane similar to that shown. A sufficient number of via holes should be used to connect the top and bottom ground planes. The evaluation circuit board shown is available from Hittite upon request. This evaluation board is designed for single ended input testing. J2 and J3 provide differential output signals.

Application Circuit

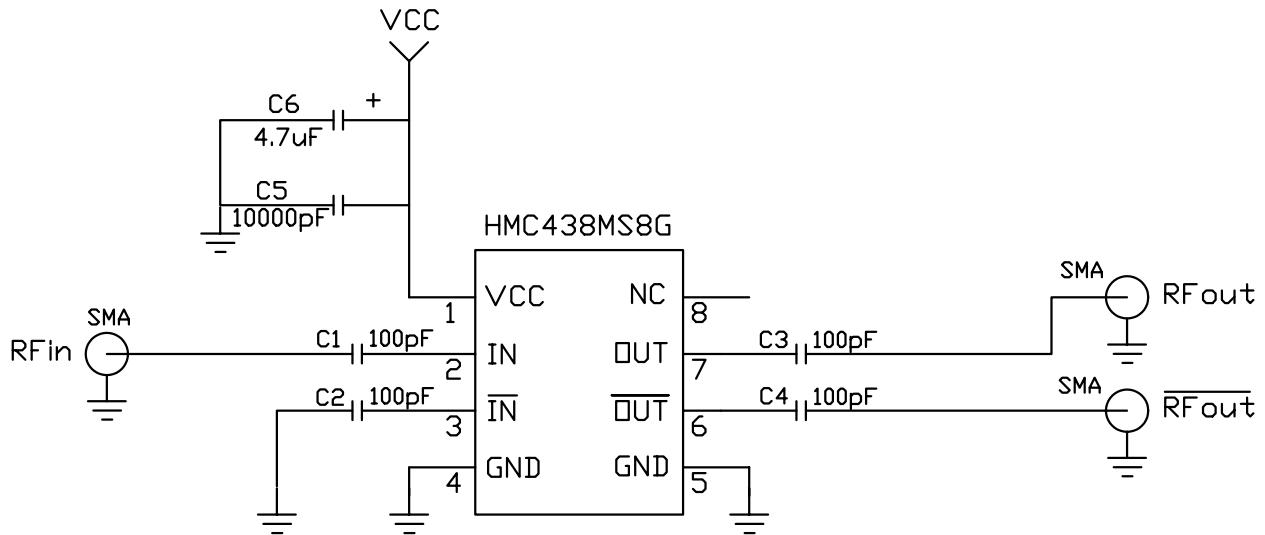



LittleDiode supplies new, hard to find or obsolete electronic components and semiconductors all over the world.

With over two million different components listed you are sure to find the part you need.

Feel free to visit us today at our online store:

LittleDiode.com

Looking forward to providing you with the best possible service.