



# CEP1012/CEB1012

March 1998

## N-Channel Enhancement Mode Field Transistor

4

### FEATURES

- 120V , 10A ,  $R_{DS(ON)}=120m\Omega$  @  $V_{GS}=10V$
- Super high dense cell design for extremely low  $R_{DS(ON)}$ .
- High power and current handling capability.
- TO-220 & TO-263 package.

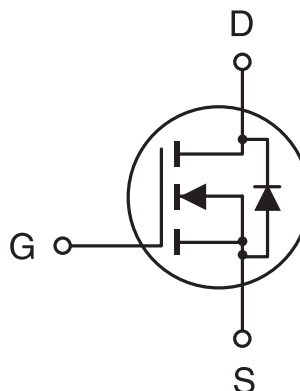
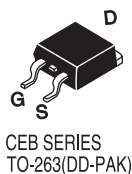

### ABSOLUTE MAXIMUM RATINGS ( $T_c=25^\circ C$ unless otherwise noted)

Parameter	Symbol	Limit	Unit
Drain-Source Voltage	$V_{DS}$	120	V
Gate-Source Voltage	$V_{GS}$	$\pm 20$	V
Drain Current-Continuous -Pulsed	$I_D$	10	A
	$I_{DM}$	40	A
Drain-Source Diode Forward Current	$I_S$	10	A
Maximum Power Dissipation @ $T_c=25^\circ C$ Derate above $25^\circ C$	$P_D$	100	W
		0.8	W/ $^\circ C$
Operating and Storage Temperature Range	$T_J, T_{STG}$	-65 to 150	$^\circ C$

### THERMAL CHARACTERISTICS

Thermal Resistance, Junction-to-Case	$R_{\theta JC}$	1.25	$^\circ C/W$
Thermal Resistance, Junction-to-Ambient	$R_{\theta JA}$	62.5	$^\circ C/W$

# CEP1012/CEB1012

4

## ELECTRICAL CHARACTERISTICS (T<sub>c</sub>=25°C unless otherwise noted)

Parameter	Symbol	Condition	Min	Typ	Max	Unit
<b>OFF CHARACTERISTICS</b>						
Drain-Source Breakdown Voltage	BV <sub>DSS</sub>	V <sub>GS</sub> =0V, I <sub>D</sub> =250μA	120			V
Zero Gate Voltage Drain Current	I <sub>DSS</sub>	V <sub>DS</sub> =120V, V <sub>GS</sub> =0V			25	μA
Gate-Body Leakage	I <sub>GSS</sub>	V <sub>GS</sub> =±20V, V <sub>DS</sub> =0V			±100	nA
<b>ON CHARACTERISTICS<sup>a</sup></b>						
Gate Threshold Voltage	V <sub>GS(th)</sub>	V <sub>DS</sub> =V <sub>GS</sub> , I <sub>D</sub> =250μA	2	2.8	4	V
Drain-Source On-State Resistance	R <sub>DS(on)</sub>	V <sub>GS</sub> =10V, I <sub>D</sub> =10A		90	120	mΩ
On-State Drain Current	I <sub>D(on)</sub>	V <sub>GS</sub> =10V, V <sub>DS</sub> =10V	10			A
Forward Transconductance	g <sub>FS</sub>	V <sub>DS</sub> =10V, I <sub>D</sub> =5A		6		S
<b>DYNAMIC CHARACTERISTICS<sup>b</sup></b>						
Input Capacitance	C <sub>ISS</sub>	V <sub>DS</sub> =25V, V <sub>GS</sub> =0V f=1.0MHz		602	800	pF
Output Capacitance	C <sub>OSS</sub>			155	210	pF
Reverse Transfer Capacitance	C <sub>RSS</sub>			67	100	pF
<b>SWITCHING CHARACTERISTICS<sup>b</sup></b>						
Turn-On Delay Time	t <sub>D(on)</sub>	V <sub>DD</sub> =30V, I <sub>D</sub> =15A, V <sub>GS</sub> =5V, R <sub>GEN</sub> =51Ω		42	60	ns
Rise Time	t <sub>r</sub>			84	120	ns
Turn-Off Delay Time	t <sub>D(off)</sub>			56	80	ns
Fall Time	t <sub>f</sub>			35	50	ns
Total Gate Charge	Q <sub>g</sub>	V <sub>DS</sub> =96V, I <sub>D</sub> =10A, V <sub>GS</sub> =10V		29	60	nC
Gate-Source Charge	Q <sub>gs</sub>			4		nC
Gate-Drain Charge	Q <sub>gd</sub>			15		nC

# CEP1012/CEB1012

## ELECTRICAL CHARACTERISTICS (T<sub>c</sub>=25°C unless otherwise noted)

4

Parameter	Symbol	Condition	Min	Typ	Max	Unit
<b>DRAIN-SOURCE DIODE CHARACTERISTICS <sup>a</sup></b>						
Diode Forward Voltage	V <sub>SD</sub>	V <sub>GS</sub> = 0V, I <sub>s</sub> = 10A		0.86	1.2	V

### Notes

- a. Pulse Test: Pulse Width ≤ 300 μs, Duty Cycle ≤ 2%.
- b. Guaranteed by design, not subject to production testing.

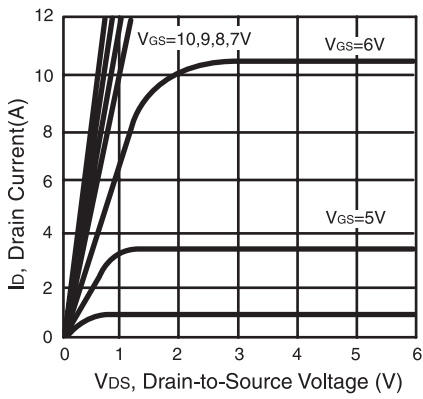

Figure 1. Output Characteristics

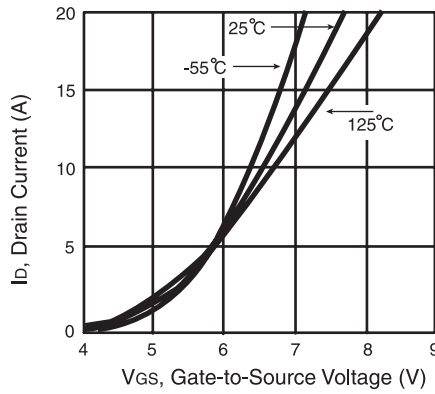

Figure 2. Transfer Characteristics

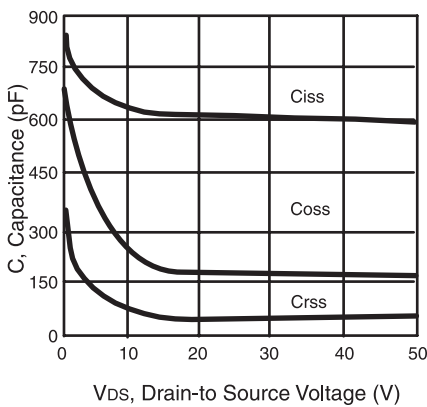

Figure 3. Capacitance

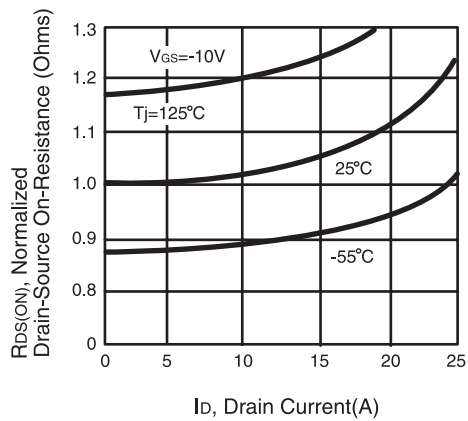
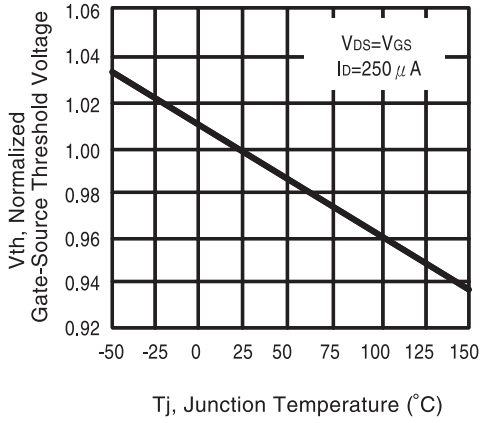

Figure 4. On-Resistance Variation with Drain Current and Temperature

# CEP1012/CEB1012

4



**Figure 5. Gate Threshold Variation with Temperature**

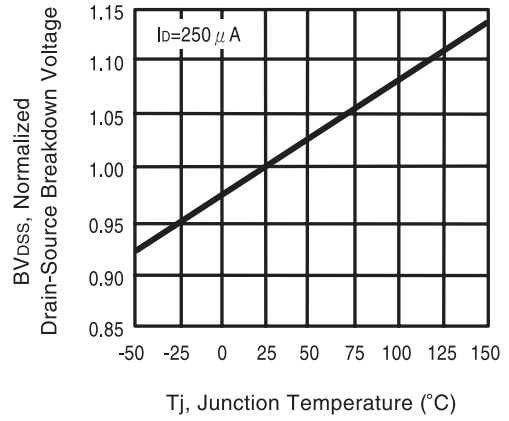

**Figure 6. Breakdown Voltage Variation with Temperature**

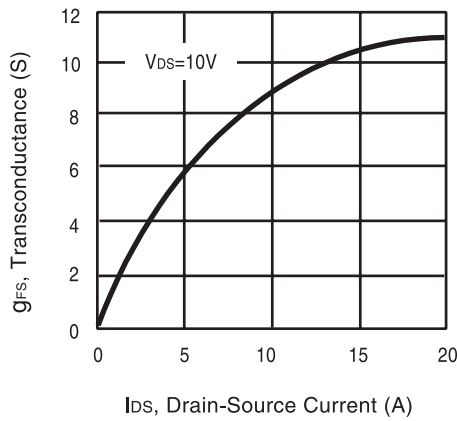

**Figure 7. Transconductance Variation with Drain Current**

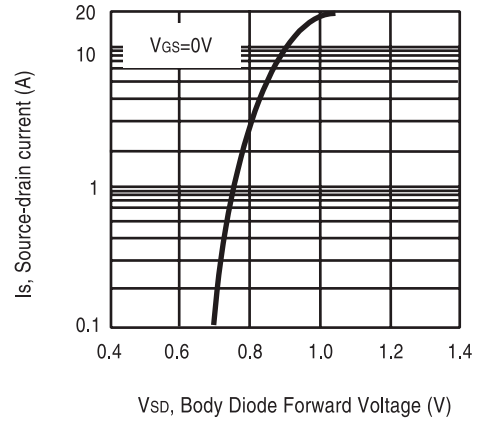

**Figure 8. Body Diode Forward Voltage Variation with Source Current**

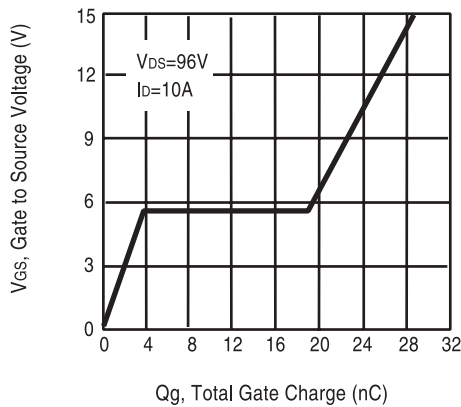

**Figure 9. Gate Charge**

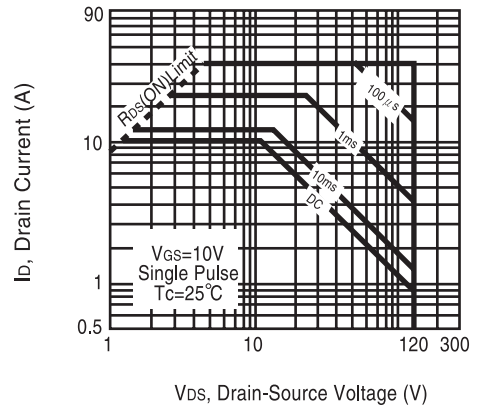

**Figure 10. Maximum Safe Operating Area**

# CEP1012/CEB1012

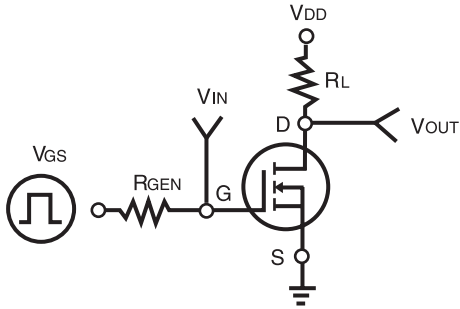

Figure 11. Switching Test Circuit

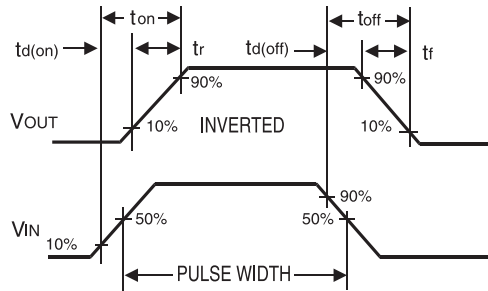

Figure 12. Switching Waveforms

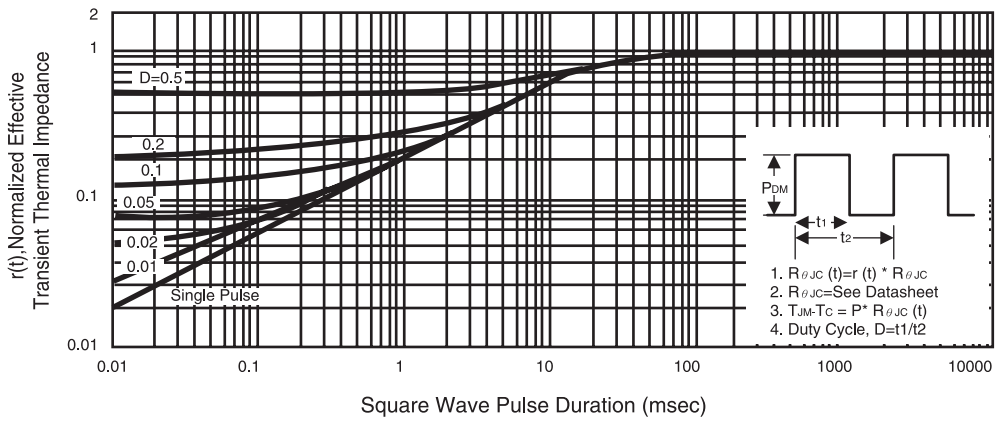

Figure 13. Normalized Thermal Transient Impedance Curve



LittleDiode supplies new, hard to find or obsolete electronic components and semiconductors all over the world.

With over two million different components listed you are sure to find the part you need.

Feel free to visit us today at our online store:

[LittleDiode.com](http://LittleDiode.com)

Looking forward to providing you with the best possible service.