



CET453N

March 1998

N-Channel Enhancement Mode Field Effect Transistor

FEATURES

- 30V , 8A , $R_{DS(ON)}=28m\Omega$ @ $V_{GS}=10V$.
 $R_{DS(ON)}=42m\Omega$ @ $V_{GS}=4.5V$.
- High dense cell design for low $R_{DS(ON)}$.
- Rugged and reliable.
- SOT-223 Package.

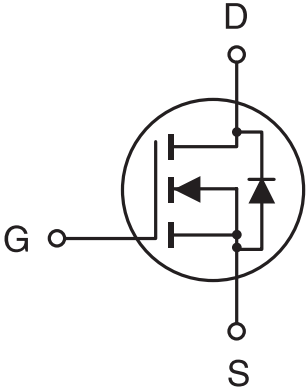

SOT-223



SOT-223 (J23Z)

8

ABSOLUTE MAXIMUM RATINGS ($T_A=25^\circ\text{C}$ unless otherwise noted)

Parameter	Symbol	Limit	Unit
Drain-Source Voltage	V _{DS}	30	V
Gate-Source Voltage	V _{GS}	±20	V
Drain Current-Continuous ^a @ $T_J=125^\circ\text{C}$ -Pulsed ^b	I _D	±8	A
	I _{DM}	±15	A
Drain-Source Diode Forward Current ^a	I _S	2.3	A
Maximum Power Dissipation ^a	P _D	3	W
Operating Junction and Storage Temperature Range	T _J , T _{STG}	-65 to 150	°C

THERMAL CHARACTERISTICS

Thermal Resistance, Junction-to-Ambient ^a	R _{θJA}	42	°C/W
--	------------------	----	------

CET453N

ELECTRICAL CHARACTERISTICS (TA=25°C unless otherwise noted)

Parameter	Symbol	Condition	Min	Typ	Max	Unit
OFF CHARACTERISTICS						
Drain-Source Breakdown Voltage	BV _{DSS}	V _{GS} = 0V, I _D =250μA	30			V
Zero Gate Voltage Drain Current	I _{DSS}	V _{DS} =24V, V _{GS} =0V			1	μA
Gate-Body Leakage	I _{GSS}	V _{GS} =±20V, V _{DS} =0V			±100	nA
ON CHARACTERISTICS^b						
Gate Threshold Voltage	V _{GS(th)}	V _{DS} =V _{GS} , I _D = 250μA	1	1.6	3	V
Drain-Source On-State Resistance	R _{DS(ON)}	V _{GS} =10V, I _D =8A		22	28	mΩ
		V _{GS} =4.5V, I _D =6.7A		33	42	mΩ
On-State Drain Current	I _{D(ON)}	V _{DS} =5V, V _{GS} =10V	15			A
Forward Transconductance	g _{FS}	V _{DS} =15V, I _D =8A	6	14		S
DYNAMIC CHARACTERISTICS^c						
Input Capacitance	C _{ISS}	V _{DS} = 15V, V _{GS} = 0V f = 1.0MHz		707	920	pF
Output Capacitance	C _{OSS}			355	460	pF
Reverse Transfer Capacitance	C _{RSS}			89	120	pF
SWITCHING CHARACTERISTICS^c						
Turn-On Delay Time	t _{D(ON)}	V _{DD} =25V, I _D = 1A, V _{GEN} =10V, R _{GEN} = 6Ω		10	15	ns
Rise Time	t _r			20	35	ns
Turn-Off Delay Time	t _{D(OFF)}			40	50	ns
Fall time	t _f			35	50	ns
Total Gate Charge	Q _g	V _{DS} =15V, I _D = 8A, V _{GS} =10V		22	35	nC
Gate-Source Charge	Q _{gs}			4		nC
Gate-Drain Charge	Q _{gd}			3		nC

CET453N

ELECTRICAL CHARACTERISTICS ($T_A=25^\circ\text{C}$ unless otherwise noted)

Parameter	Symbol	Condition	Min	Typ	Max	Unit
DRAIN-SOURCE DIODE CHARACTERISTICS^b						
Diode Forward Voltage	V_{SD}	$V_{GS} = 0V, I_S = 8A$		0.8	1.3	V

Notes

- a. Surface Mounted on FR4 Board, $t \leq 10\text{sec}$.
- b. Pulse Test: Pulse Width $\leq 300\mu\text{s}$, Duty Cycle $\leq 2\%$.
- c. Guaranteed by design, not subject to production testing.

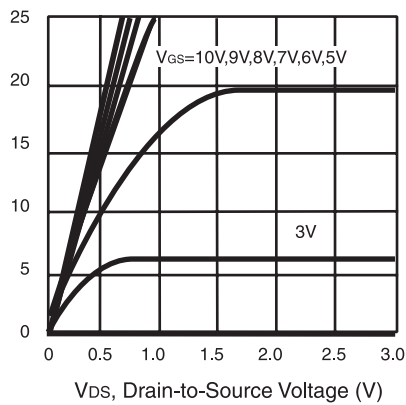

Figure 1. Output Characteristics

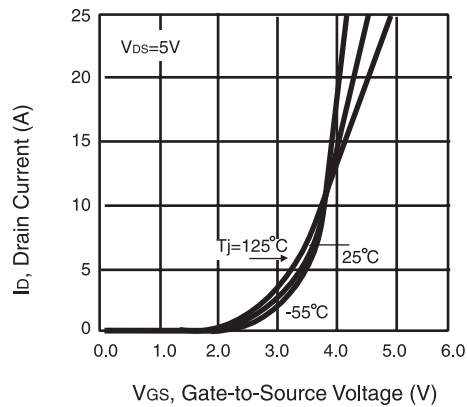

Figure 2. Transfer Characteristics

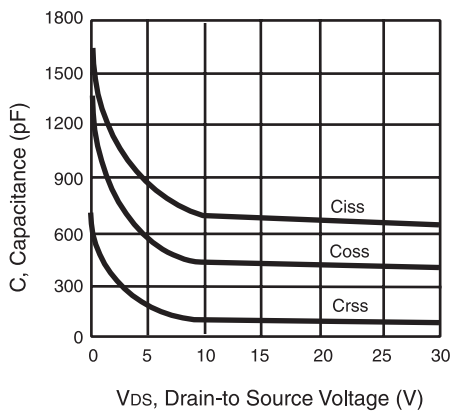

Figure 3. Capacitance

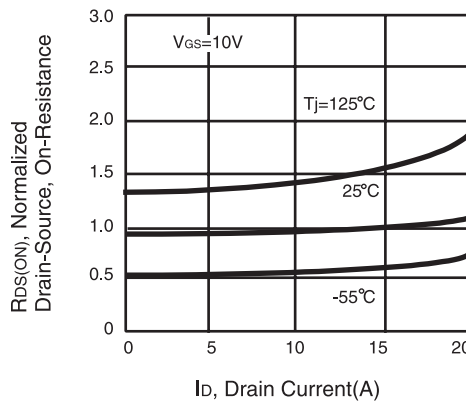

Figure 4. On-Resistance Variation with Drain Current and Temperature

CET453N

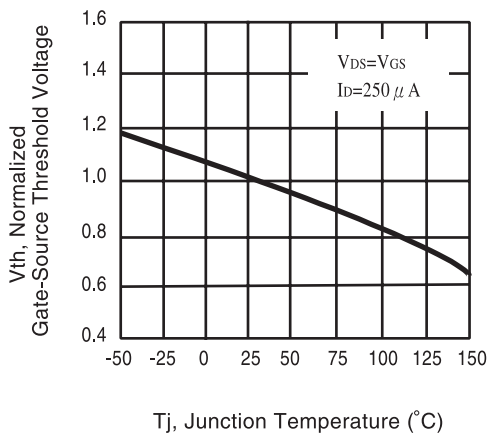

Figure 5. Gate Threshold Variation with Temperature

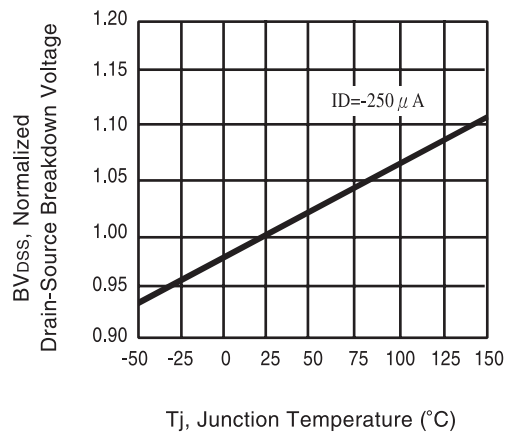

Figure 6. Breakdown Voltage Variation with Temperature

8

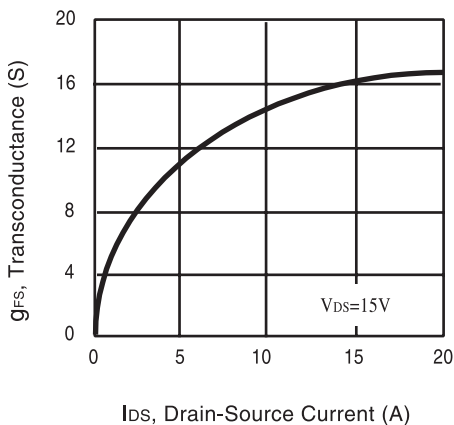

Figure 7. Transconductance Variation with Drain Current

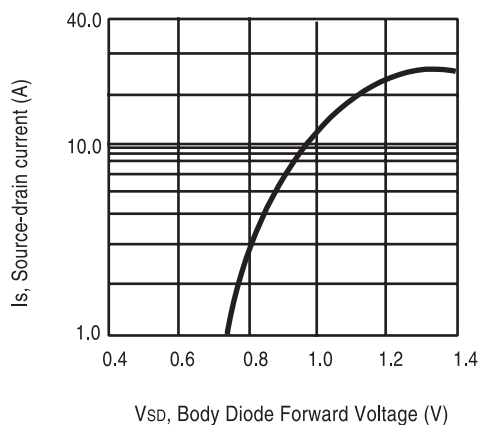

Figure 8. Body Diode Forward Voltage Variation with Source Current

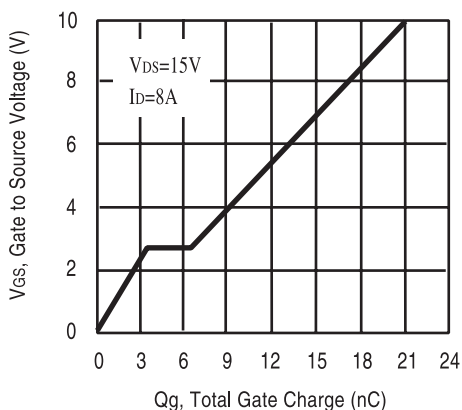

Figure 9. Gate Charge

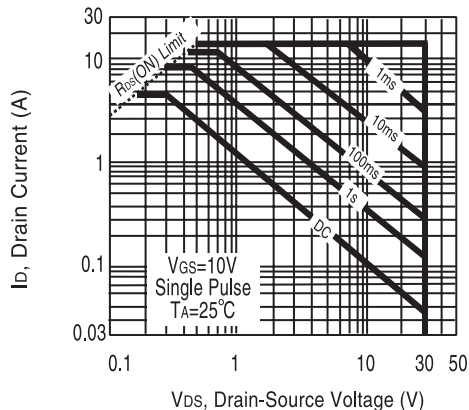

Figure 10. Maximum Safe Operating Area

CET453N

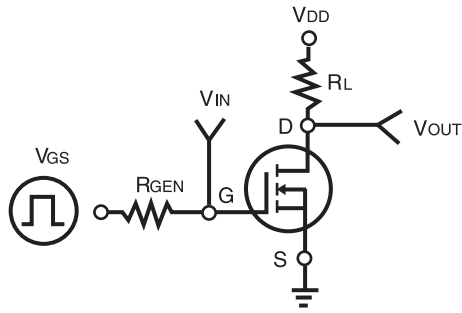

Figure 11. Switching Test Circuit

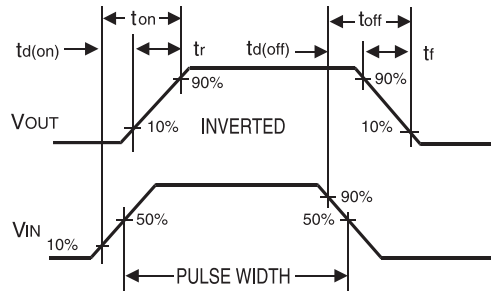

Figure 12. Switching Waveforms

8

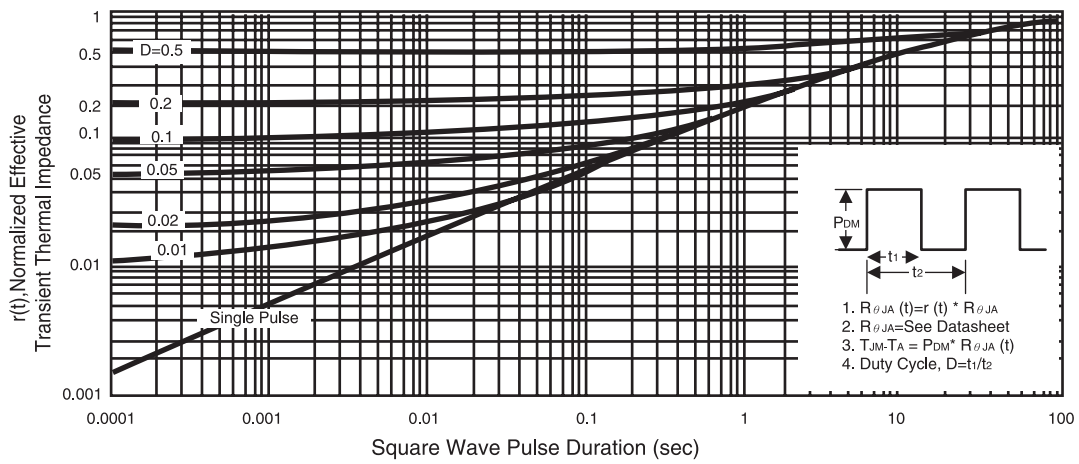

Figure 13. Normalized Thermal Transient Impedance Curve



LittleDiode supplies new, hard to find or obsolete electronic components and semiconductors all over the world.

With over two million different components listed you are sure to find the part you need.

Feel free to visit us today at our online store:

LittleDiode.com

Looking forward to providing you with the best possible service.