

CEP7060R/CEB7060R



March 1998

4

N-Channel Enhancement Mode Field Effect Transistor

FEATURES

- 60V , 75A , $R_{DS(ON)}=13m\Omega$ @ $V_{GS}=10V$.
- Super high dense cell design for extremely low $R_{DS(ON)}$.
- High power and current handling capability.
- TO-220 & TO-263 package.

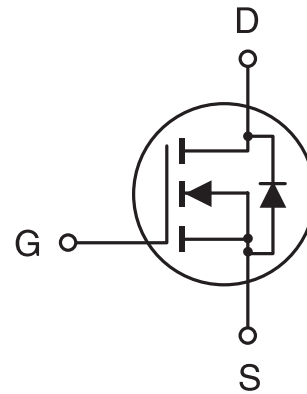

ABSOLUTE MAXIMUM RATINGS ($T_c=25^\circ\text{C}$ unless otherwise noted)

Parameter	Symbol	Limit	Unit
Drain-Source Voltage	V_{DS}	60	V
Gate-Source Voltage	V_{GS}	± 20	V
Drain Current-Continuous -Pulsed	I_D	75	A
	I_{DM}	225	A
Drain-Source Diode Forward Current	I_S	75	A
Maximum Power Dissipation @ $T_c=25^\circ\text{C}$ Derate above 25°C	P_D	150	W
		1	W/ $^\circ\text{C}$
Operating and Storage Temperature Range	T_J, T_{STG}	-65 to 175	$^\circ\text{C}$

THERMAL CHARACTERISTICS

Thermal Resistance, Junction-to-Case	$R_{\theta JC}$	1	$^\circ\text{C/W}$
Thermal Resistance, Junction-to-Ambient	$R_{\theta JA}$	62.5	$^\circ\text{C/W}$

CEP7060R/CEB7060R

ELECTRICAL CHARACTERISTICS (Tc=25°C unless otherwise noted)

4

Parameter	Symbol	Condition	Min	Typ	Max	Unit
DRAIN-SOURCE AVALANCHE RATING^a						
Single Pulse Drain-Source Avalanche Energy	EAS	V _{DD} =25V, I _D =150A		430		mJ
Maximum Drain-Source Avalanche Current	I _{AS}	L=25μH		150		A
OFF CHARACTERISTICS						
Drain-Source Breakdown Voltage	BV _{DSS}	V _{GS} =0V, I _D =250μA	60			V
Zero Gate Voltage Drain Current	I _{DSS}	V _{DS} =60V, V _{GS} =0V			25	μA
Gate-Body Leakage	I _{GSS}	V _{GS} =±20V, V _{DS} =0V			±100	nA
ON CHARACTERISTICS^a						
Gate Threshold Voltage	V _{GS(th)}	V _{DS} =V _{GS} , I _D =250μA	2	2.8	4	V
Drain-Source On-State Resistance	R _{DS(ON)}	V _{GS} =10V, I _D =40A		11	13	mΩ
On-State Drain Current	I _{D(ON)}	V _{GS} =10V, V _{DS} =10V	60			A
Forward Transconductance	g _{FS}	V _{DS} =10V, I _D =37.5A		39		S
SWITCHING CHARACTERISTICS^b						
Turn-On Delay Time	t _{D(ON)}	V _{DD} =30V, I _D =75A, V _{GS} =10V		20	30	ns
Rise Time	t _r			250	400	ns
Turn-Off Delay Time	t _{D(OFF)}			45	80	ns
Fall Time	t _f			130	200	ns
Total Gate Charge	Q _g	V _{DS} =48V, I _D =75A, V _{GS} =10V		61	115	nC
Gate-Source Charge	Q _{gs}			15		nC
Gate-Drain Charge	Q _{gd}			18		nC

CEP7060R/CEB7060R

ELECTRICAL CHARACTERISTICS ($T_c=25^\circ\text{C}$ unless otherwise noted)

4

Parameter	Symbol	Condition	Min	Typ	Max	Unit
DYNAMIC CHARACTERISTICS^b						
Input Capacitance	C_{iss}	$V_{DS}=25\text{V}, V_{GS}=0\text{V}$ $f=1.0\text{MHz}$		2810	3600	pF
Output Capacitance	C_{oss}			1075	1600	pF
Reverse Transfer Capacitance	C_{rss}			360	800	pF
DRAIN-SOURCE DIODE CHARACTERISTICS^a						
Diode Forward Voltage	V_{SD}	$V_{GS}=0\text{V}, I_S=37.5\text{A}$		0.9	1.3	V

Notes

a. Pulse Test: Pulse Width $\leq 300 \mu\text{s}$, Duty Cycle $\leq 2\%$.

b. Guaranteed by design, not subject to production testing.

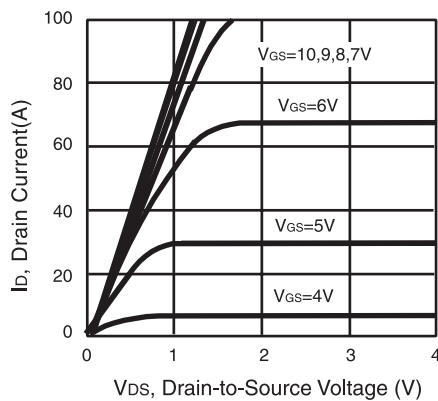

Figure 1. Output Characteristics

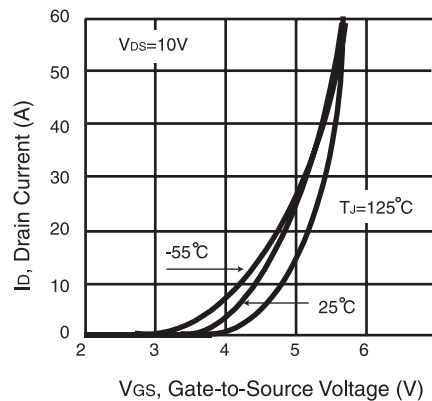

Figure 2. Transfer Characteristics

CEP7060R/CEB7060R

4

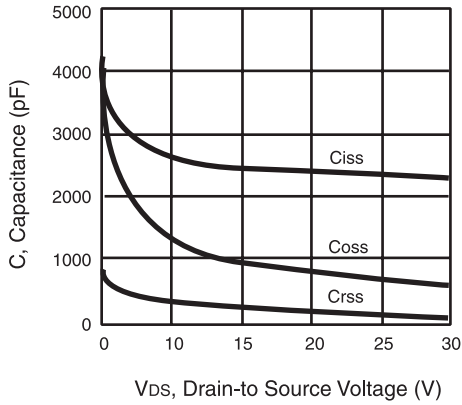

Figure 3. Capacitance

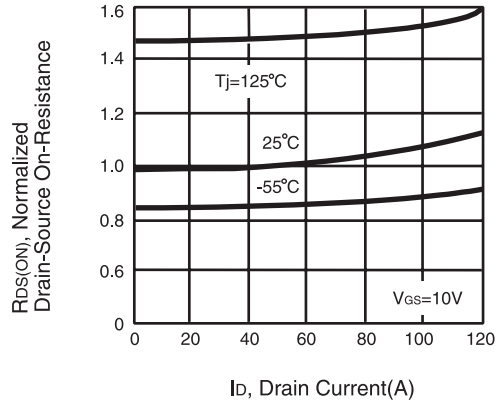

Figure 4. On-Resistance Variation with Drain Current and Temperature

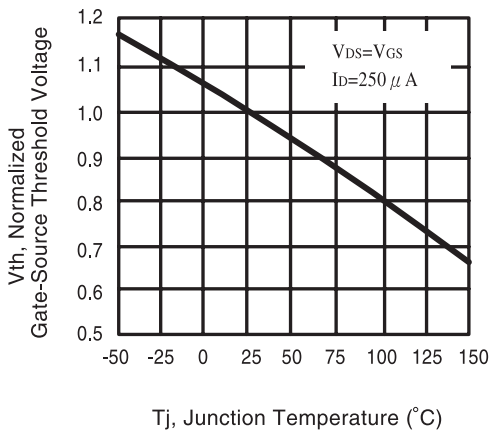

Figure 5. Gate Threshold Variation with Temperature

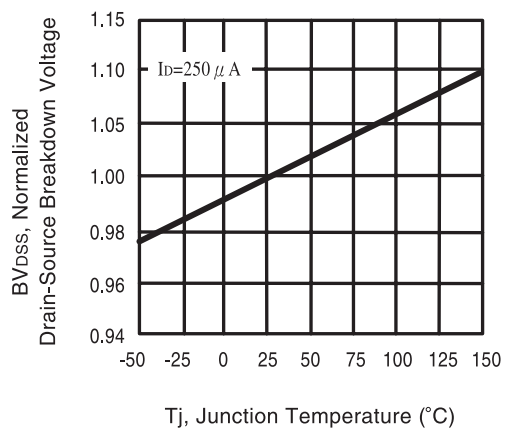

Figure 6. Breakdown Voltage Variation with Temperature

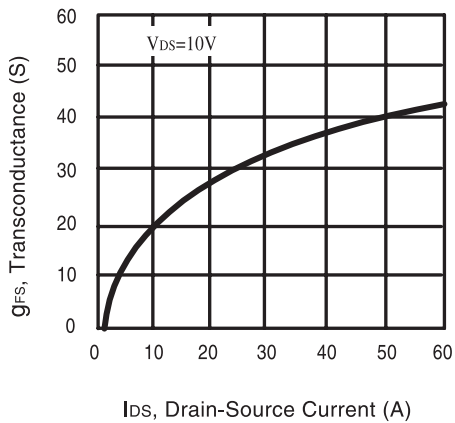

Figure 7. Transconductance Variation with Drain Current

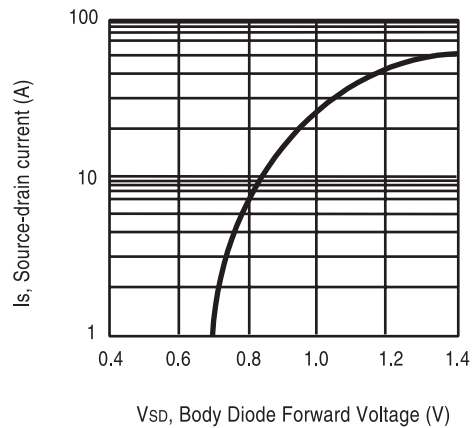

Figure 8. Body Diode Forward Voltage Variation with Source Current

CEP7060R/CEB7060R

4

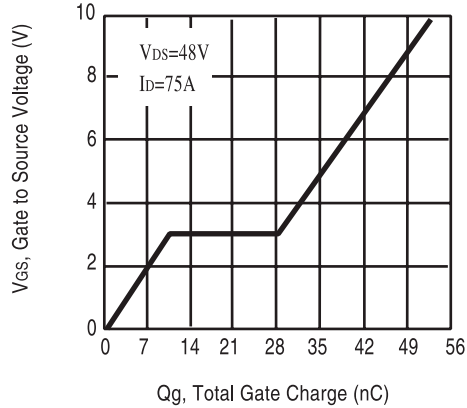

Figure 9. Gate Charge

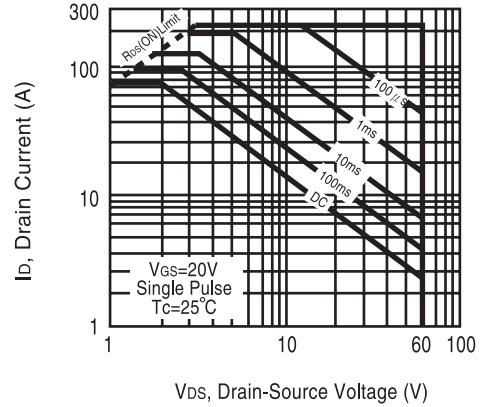

Figure 10. Maximum Safe Operating Area

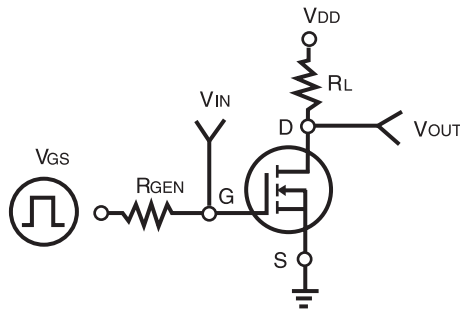

Figure 11. Switching Test Circuit

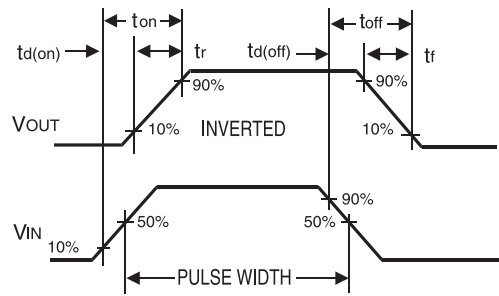

Figure 12. Switching Waveforms

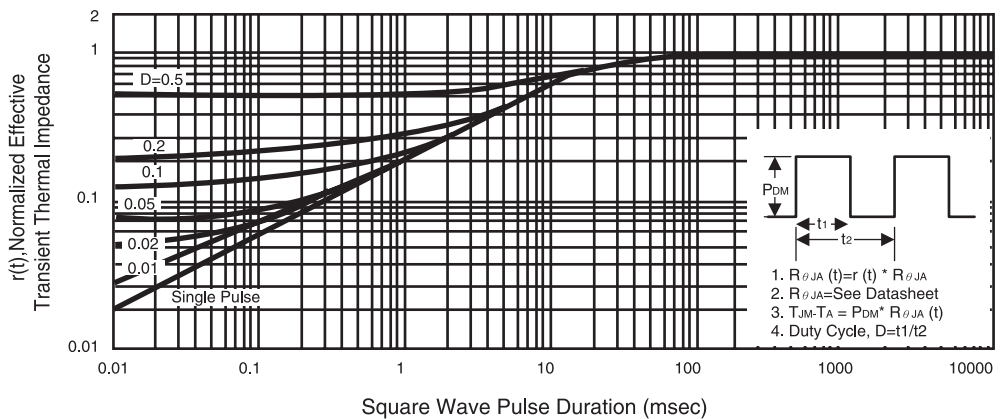

Figure 13. Normalized Thermal Transient Impedance Curve



LittleDiode supplies new, hard to find or obsolete electronic components and semiconductors all over the world.

With over two million different components listed you are sure to find the part you need.

Feel free to visit us today at our online store:

LittleDiode.com

Looking forward to providing you with the best possible service.