

Features

- Dual N-Channel MOSFET
- Low On-Resistance
 - 26mΩ @ $V_{GS} = 4.5V$
 - 36mΩ @ $V_{GS} = 2.5V$
- Low Gate Threshold Voltage
- Low Input Capacitance
- Fast Switching Speed
- Low Input/Output Leakage
- **Lead Free By Design/RoHS Compliant (Note 2)**
- **"Green" Device (Note 4)**
- **Qualified to AEC-Q 101 Standards for High Reliability**

Mechanical Data

- Case: SOP-8L
- Case Material: Molded Plastic, "Green" Molding Compound. UL Flammability Classification Rating 94V-0
- Moisture Sensitivity: Level 1 per J-STD-020D
- Terminals Connections: See Diagram
- Terminals: Finish - Matte Tin annealed over Copper lead frame. Solderable per MIL-STD-202, Method 208
- Marking Information: See Page 4
- Ordering Information: See Page 4
- Weight: 0.072 grams (approximate)

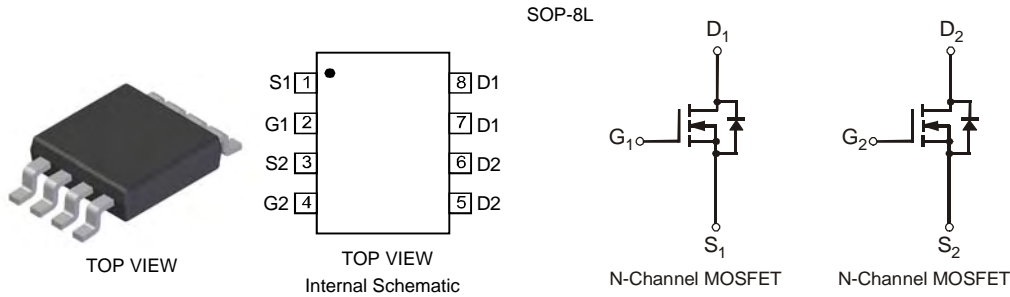

Maximum Ratings @ $T_A = 25^\circ C$ unless otherwise specified

Characteristic	Symbol	Value	Units	
Drain-Source Voltage	V_{DSS}	20	V	
Gate-Source Voltage	V_{GSS}	± 12	V	
Drain Current (Note 1)	Steady State	$T_A = 25^\circ C$	7.0	A
		$T_A = 70^\circ C$	5.6	A
Pulsed Drain Current (Note 3)	I_{DM}	30	A	

Thermal Characteristics

Characteristic	Symbol	Value	Unit
Total Power Dissipation (Note 1)	P_D	2	W
Thermal Resistance, Junction to Ambient	$R_{\theta JA}$	62.5	$^\circ C/W$
Operating and Storage Temperature Range	T_J, T_{STG}	-55 to +150	$^\circ C$

Electrical Characteristics @ $T_A = 25^\circ C$ unless otherwise specified

Characteristic	Symbol	Min	Typ	Max	Unit	Test Condition
OFF CHARACTERISTICS (Note 5)						
Drain-Source Breakdown Voltage	BV_{DSS}	20	—	—	V	$V_{GS} = 0V, I_D = 250\mu A$
Zero Gate Voltage Drain Current	I_{DSS}	—	—	1	μA	$V_{DS} = 20V, V_{GS} = 0V$
Gate-Source Leakage	I_{GSS}	—	—	± 100	nA	$V_{GS} = \pm 12V, V_{DS} = 0V$
ON CHARACTERISTICS (Note 5)						
Gate Threshold Voltage	$V_{GS(th)}$	0.6	—	1.2	V	$V_{DS} = V_{GS}, I_D = 250\mu A$
Static Drain-Source On-Resistance	$R_{DS(on)}$	—	19	26	mΩ	$V_{GS} = 4.5V, I_D = 6.0A$
		—	26	36		$V_{GS} = 2.5V, I_D = 5.2A$
Forward Transfer Admittance	g_{fs}	—	12	—	ms	$V_{DS} = 10V, I_D = 6.0A$
Diode Forward Voltage (Note 5)	V_{SD}	0.5	—	1.2	V	$V_{GS} = 0V, I_S = 1.7A$
DYNAMIC CHARACTERISTICS						
Input Capacitance	C_{iss}	—	562	—	pF	$V_{DS} = 10V, V_{GS} = 0V$ $f = 1.0MHz$
Output Capacitance	C_{oss}	—	75	—	pF	
Reverse Transfer Capacitance	C_{rss}	—	65	—	pF	

- Notes:
1. Device mounted on 2 oz. Copper pads on FR-4 PCB.
 2. No purposefully added lead.
 3. Pulse width $\leq 10\mu S$, Duty Cycle $\leq 1\%$.
 4. Diodes Inc.'s "Green" policy can be found on our website at http://www.diodes.com/products/lead_free/index.php.
 5. Short duration pulse test used to minimize self-heating effect.

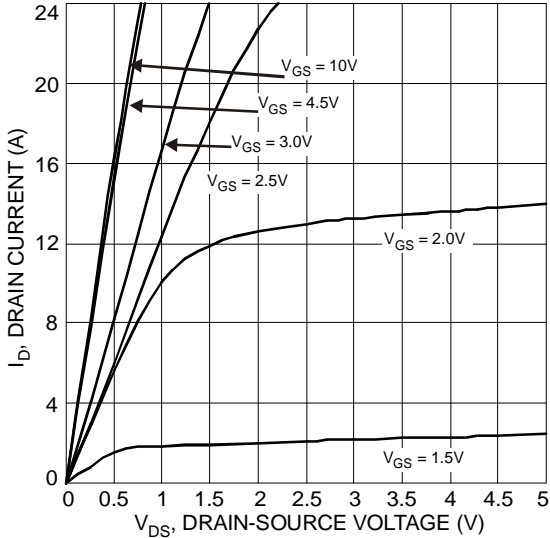

Fig. 1 Typical Output Characteristics

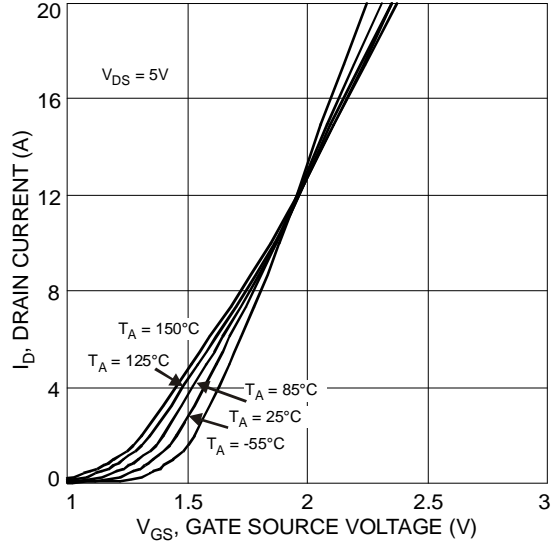

Fig. 2 Typical Transfer Characteristics

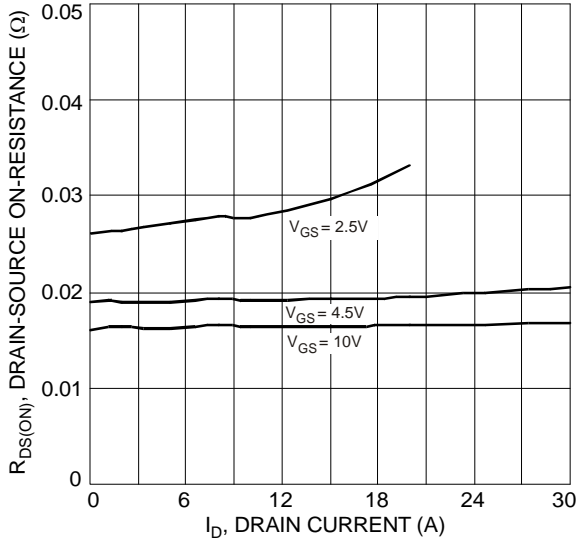

Fig. 3 Typical On-Resistance vs. Drain Current and Gate Voltage

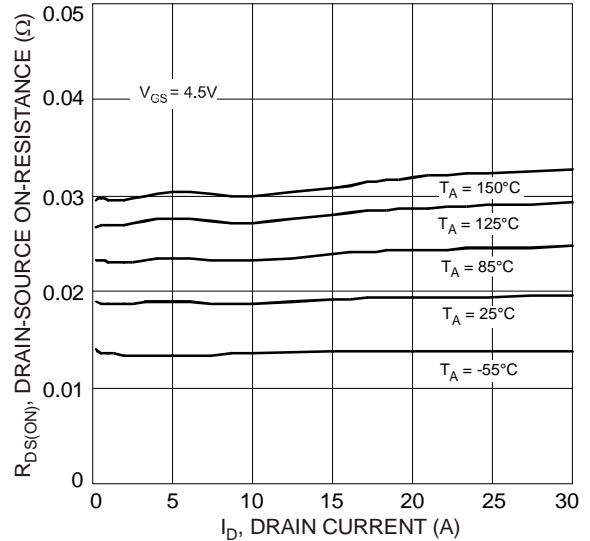

Fig. 4 Typical Drain-Source On-Resistance vs. Drain Current and Temperature

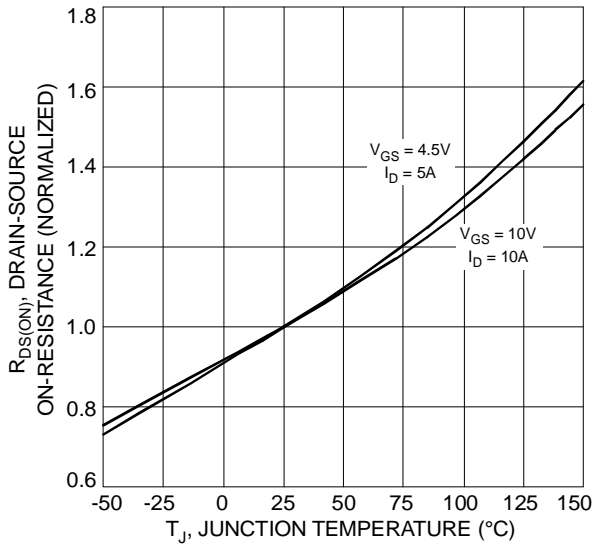

Fig. 5 On-Resistance Variation with Temperature

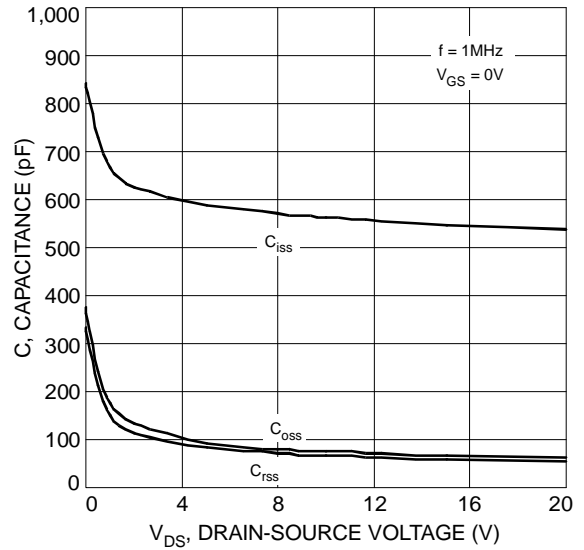

Fig. 6 Typical Capacitance

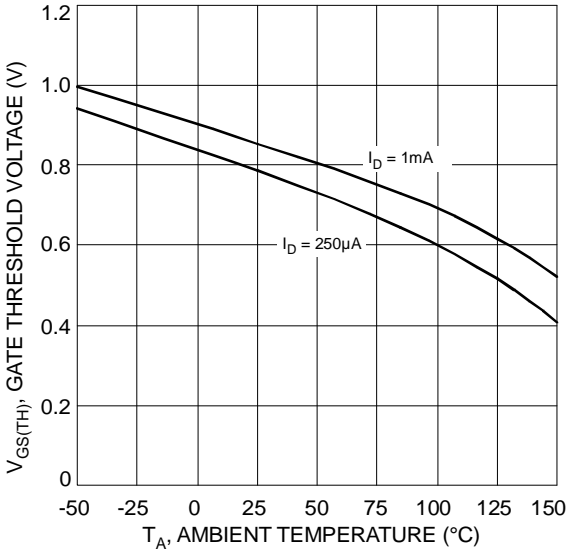

Fig. 7 Gate Threshold Variation vs. Ambient Temperature

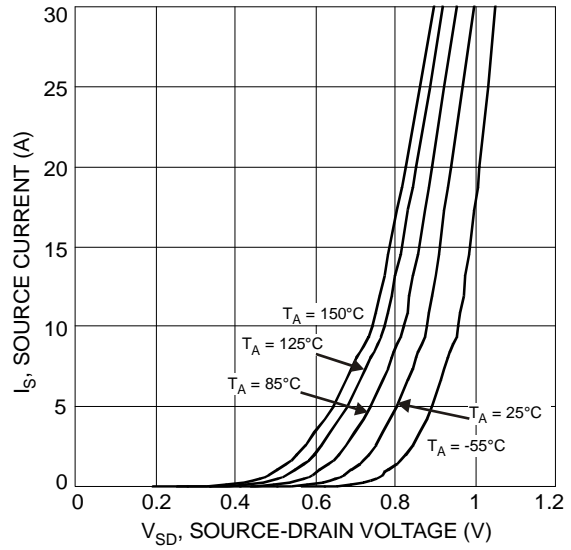

Fig. 8 Diode Forward Voltage vs. Current

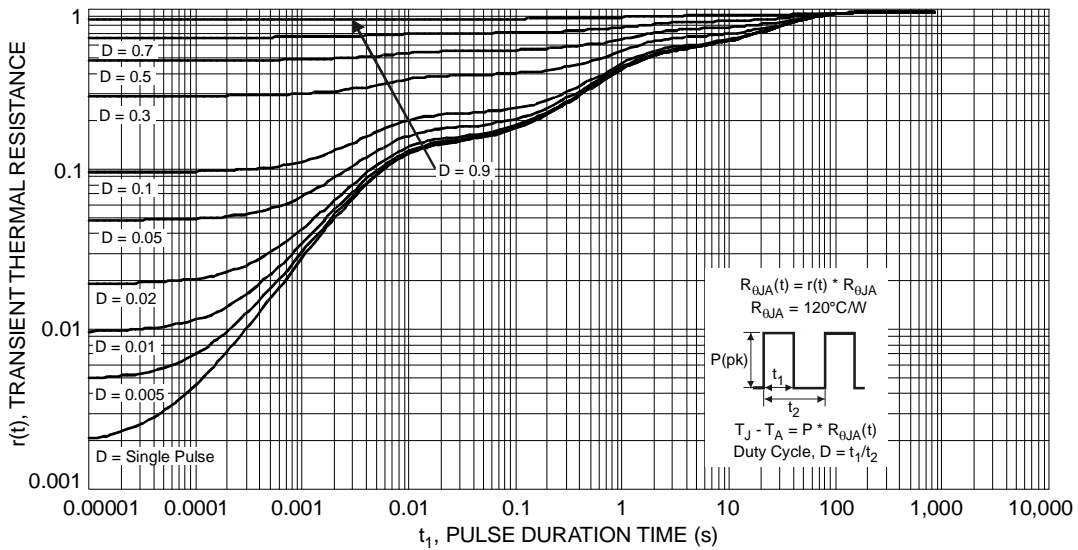

Fig. 9 Transient Thermal Response

Ordering Information (Note 6)

Part Number	Case	Packaging
DMN2040LSD-13	SOP-8L	2500/Tape & Reel

Notes: 6. For packaging details, go to our website at <http://www.diodes.com/datasheets/ap02007.pdf>.

Marking Information

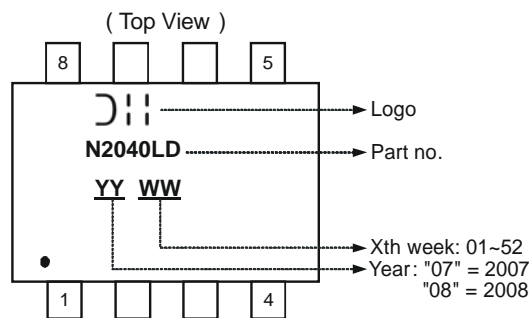

Package Outline Dimensions

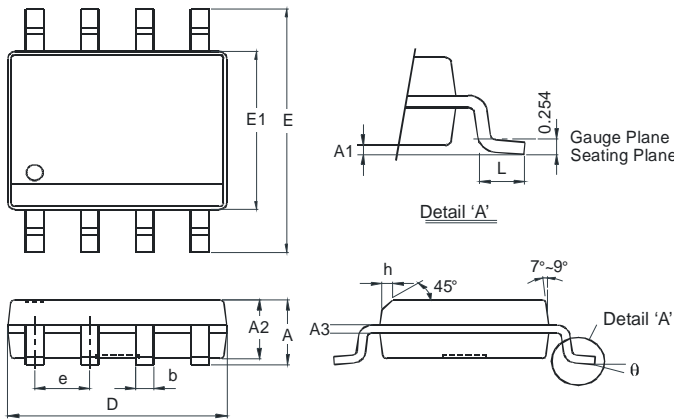

SOP-8L		
Dim	Min	Max
A	-	1.75
A1	0.08	0.25
A2	1.40	1.50
A3	0.20 Typ	
b	0.3	0.5
D	4.85	4.95
E	5.90	6.10
E1	3.80	3.90
e	1.27 Typ	
h	-	0.35
L	0.60	0.80
θ	0°	8°
All Dimensions in mm		

Suggested Pad Layout

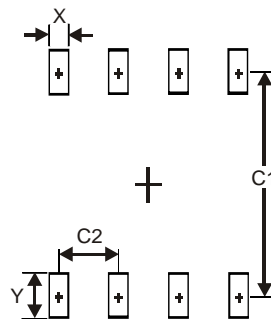

Dimensions	Value (in mm)
X	0.60
Y	1.55
C1	5.4
C2	1.27

IMPORTANT NOTICE

Diodes Incorporated and its subsidiaries reserve the right to make modifications, enhancements, improvements, corrections or other changes without further notice to any product herein. Diodes Incorporated does not assume any liability arising out of the application or use of any product described herein; neither does it convey any license under its patent rights, nor the rights of others. The user of products in such applications shall assume all risks of such use and will agree to hold Diodes Incorporated and all the companies whose products are represented on our website, harmless against all damages.

LIFE SUPPORT

Diodes Incorporated products are not authorized for use as critical components in life support devices or systems without the expressed written approval of the President of Diodes Incorporated.



LittleDiode supplies new, hard to find or obsolete electronic components and semiconductors all over the world.

With over two million different components listed you are sure to find the part you need.

Feel free to visit us today at our online store:

LittleDiode.com

Looking forward to providing you with the best possible service.