

Features

- DIOFET utilizes a unique patented process to monolithically integrate a MOSFET and a Schottky in a single die to deliver:
 - Low $R_{DS(ON)}$ - minimizes conduction losses
 - Low V_{SD} - reducing the losses due to body diode conduction
 - Low Q_{rr} - lower Q_{rr} of the integrated Schottky reduces body diode switching losses
 - Low gate capacitance (Q_g/Q_{gs}) ratio – reduces risk of shoot-through or cross conduction currents at high frequencies
 - Avalanche rugged – I_{AR} and E_{AR} rated
- Lead Free, RoHS Compliant (Note 1)**
- "Green" Device (Note 2)**
- Qualified to AEC-Q101 Standards for High Reliability**

Mechanical Data

- Case: SO-8
- Case Material: Molded Plastic, "Green" Molding Compound. UL Flammability Classification Rating 94V-0
- Moisture Sensitivity: Level 1 per J-STD-020
- Terminal Connections: See Diagram Below
- Marking Information: See Page 5
- Ordering Information: See Page 5
- Weight: 0.072 grams (approximate)

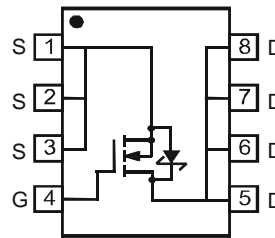

Top View

 Top View
Internal Schematic

Maximum Ratings @ $T_A = 25^\circ\text{C}$ unless otherwise specified

Characteristic	Symbol	Value	Unit
Drain-Source Voltage	V_{DSS}	30	V
Gate-Source Voltage	V_{GSS}	± 12	V
Continuous Drain Current (Note 3) $V_{GS} = 4.5\text{V}$	I_D	$T_A = 25^\circ\text{C}$ $T_A = 85^\circ\text{C}$	A
		9.8 6.3	
Pulsed Drain Current (Note 4)	I_{DM}	90	A
Avalanche Current (Note 4) (Note 5)	I_{AR}	13	A
Repetitive Avalanche Energy (Note 4) (Note 5) $L = 0.3\text{mH}$	E_{AR}	25.4	mJ

Thermal Characteristics

Characteristic	Symbol	Value	Unit
Power Dissipation (Note 3)	P_D	1.54	W
Thermal Resistance, Junction to Ambient @ $T_A = 25^\circ\text{C}$ (Note 3)	$R_{\theta JA}$	81	$^\circ\text{C/W}$
Operating and Storage Temperature Range	T_J, T_{STG}	-55 to +150	$^\circ\text{C}$

- Notes:
- No purposefully added lead.
 - Diodes Inc.'s "Green" policy can be found on our website at http://www.diodes.com/products/lead_free/index.php.
 - Device mounted on minimum recommended layout. The value in any given application depends on the user's specific board design.
 - Repetitive rating, pulse width limited by junction temperature.
 - I_{AR} and E_{AR} rating are based on low frequency and duty cycles to keep $T_J = 25^\circ\text{C}$

Electrical Characteristics @ $T_A = 25^\circ\text{C}$ unless otherwise stated

Characteristic	Symbol	Min	Typ	Max	Unit	Test Condition
OFF CHARACTERISTICS (Note 6)						
Drain-Source Breakdown Voltage	BV_{DSS}	30	-	-	V	$V_{GS} = 0V, I_D = 250\mu A$
Zero Gate Voltage Drain Current	I_{DSS}	-	-	0.1	mA	$V_{DS} = 30V, V_{GS} = 0V$
Gate-Source Leakage	I_{GSS}	-	-	± 100	nA	$V_{GS} = \pm 12V, V_{DS} = 0V$
ON CHARACTERISTICS (Note 6)						
Gate Threshold Voltage	$V_{GS(th)}$	1.0	-	2.3	V	$V_{DS} = V_{GS}, I_D = 250\mu A$
Static Drain-Source On-Resistance	$R_{DS(on)}$	-	9	13	$m\Omega$	$V_{GS} = 10V, I_D = 9.8A$
		-	11	16		$V_{GS} = 4.5V, I_D = 9.8A$
Forward Transfer Admittance	$ Y_{fs} $	-	5	-	S	$V_{DS} = 5V, I_D = 9.8A$
Diode Forward Voltage	V_{SD}	-	0.4	1	V	$V_{GS} = 0V, I_S = 1A$
Maximum Body-Diode + Schottky Continuous Current	I_S	-	-	5	A	-
DYNAMIC CHARACTERISTICS (Note 7)						
Input Capacitance	C_{iss}	-	1849	-	pF	$V_{DS} = 15V, V_{GS} = 0V,$ $f = 1.0MHz$
Output Capacitance	C_{oss}	-	158	-	pF	
Reverse Transfer Capacitance	C_{rss}	-	123	-	pF	
Gate Resistance	R_g	0.53	2.68	4.82	Ω	$V_{DS} = 0V, V_{GS} = 0V, f = 1MHz$
Total Gate Charge $V_{GS} = 4.5V$	Q_g	-	18.5	-	nC	$V_{DS} = 15V, V_{GS} = 10V,$ $I_D = 9.8A$
Total Gate Charge $V_{GS} = 10V$	Q_g	-	43	-	nC	
Gate-Source Charge	Q_{gs}	-	4.7	-	nC	
Gate-Drain Charge	Q_{gd}	-	4.0	-	nC	
Turn-On Delay Time	$t_{D(on)}$	-	6.62	-	ns	$V_{GS} = 10V, V_{DS} = 10V,$ $R_G = 3\Omega, R_L = 1.2\Omega$
Turn-On Rise Time	t_r	-	8.73	-	ns	
Turn-Off Delay Time	$t_{D(off)}$	-	36.41	-	ns	
Turn-Off Fall Time	t_f	-	4.69	-	ns	

- Notes: 6. Short duration pulse test used to minimize self-heating effect.
7. Guaranteed by design. Not subject to production testing.

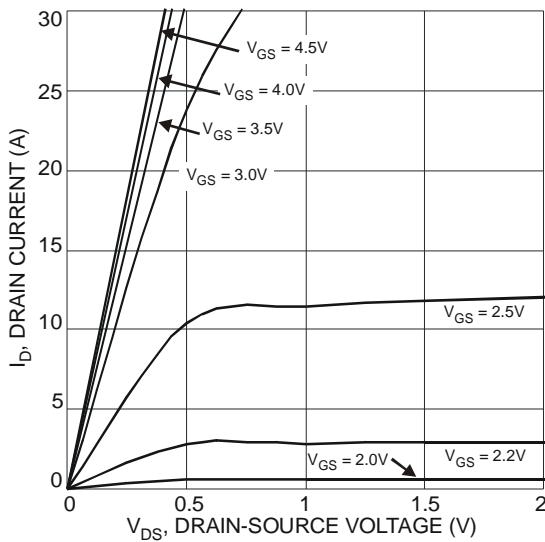

Fig. 1 Typical Output Characteristic

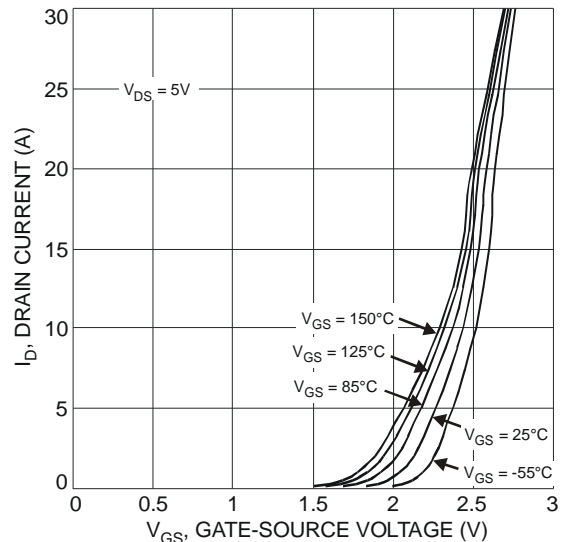

Fig. 2 Typical Transfer Characteristic

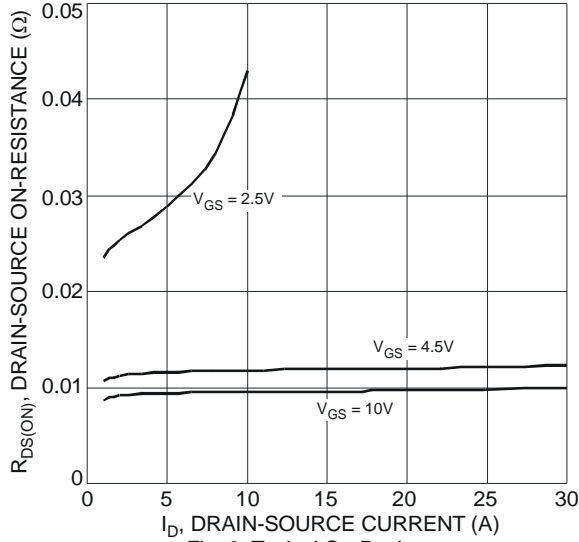

Fig. 3 Typical On-Resistance vs. Drain Current and Gate Voltage

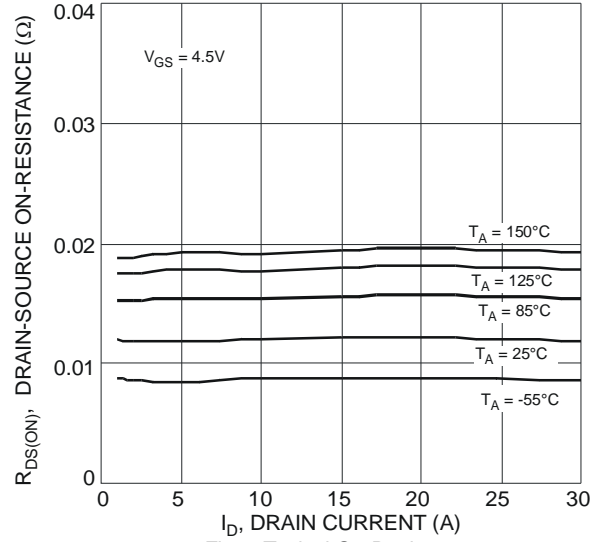

Fig. 4 Typical On-Resistance vs. Drain Current and Temperature

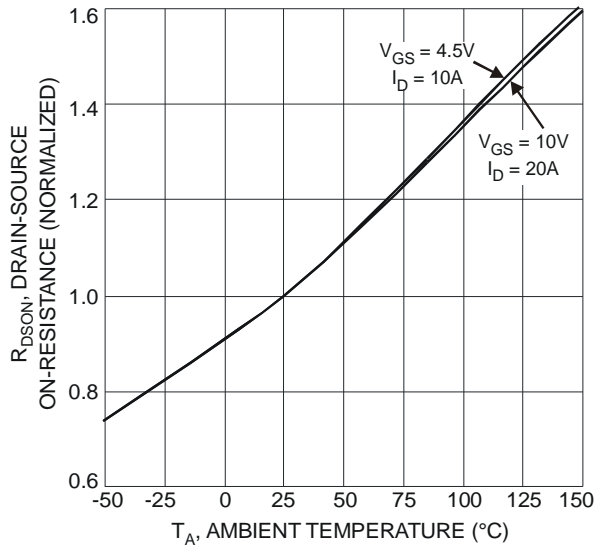

Fig. 5 On-Resistance Variation with Temperature

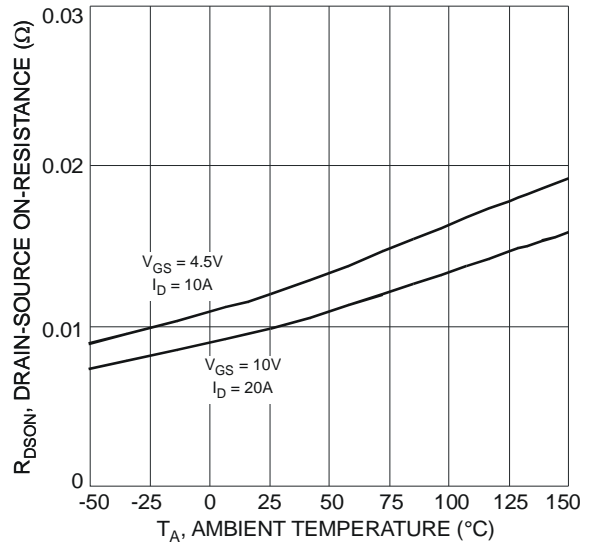

Fig. 6 On-Resistance Variation with Temperature

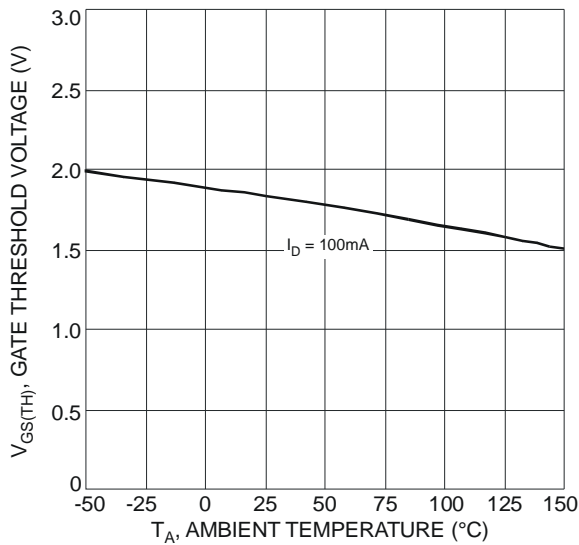

Fig. 7 Gate Threshold Variation vs. Ambient Temperature

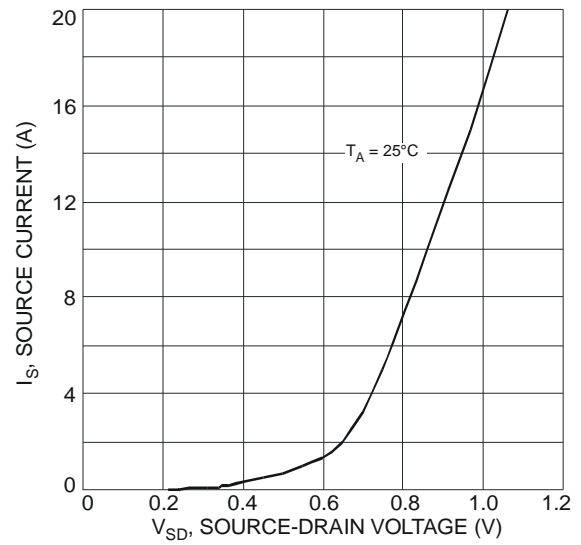
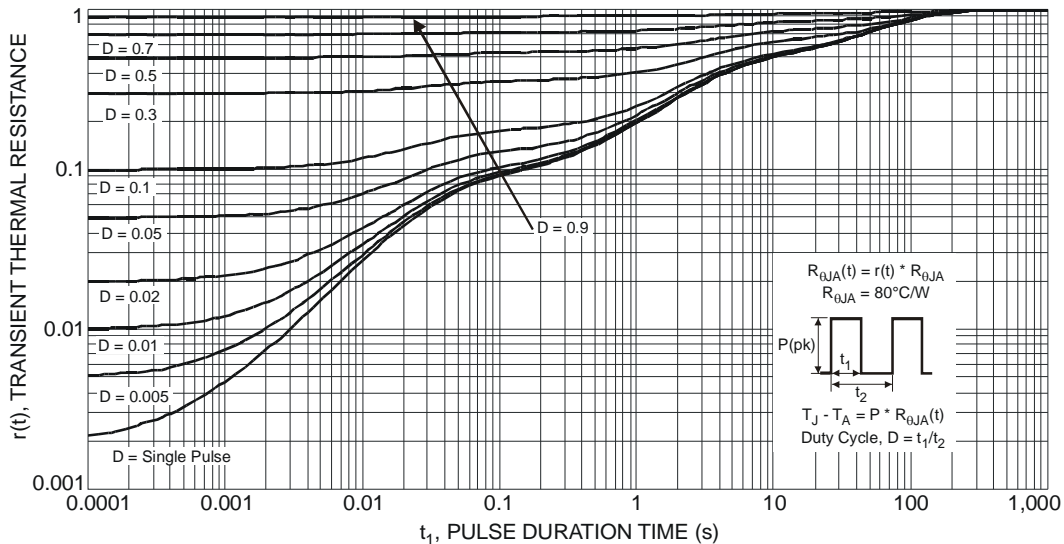
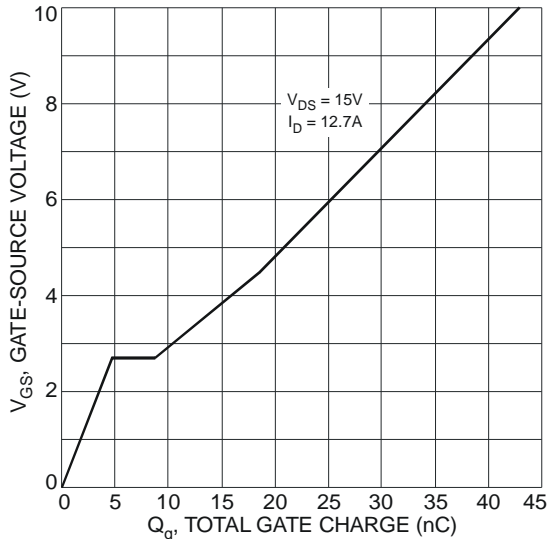
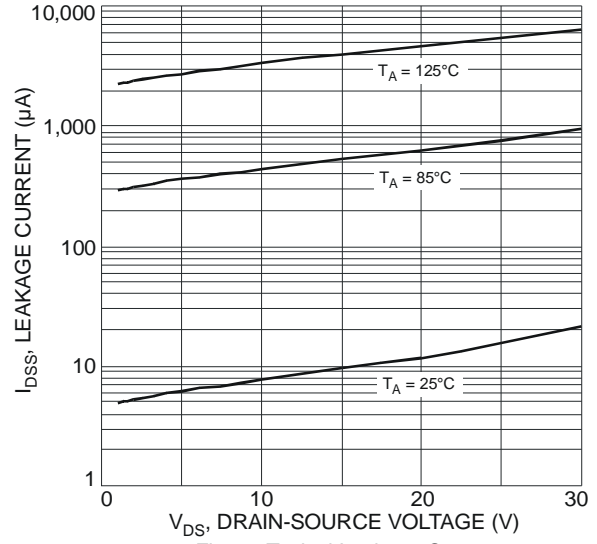
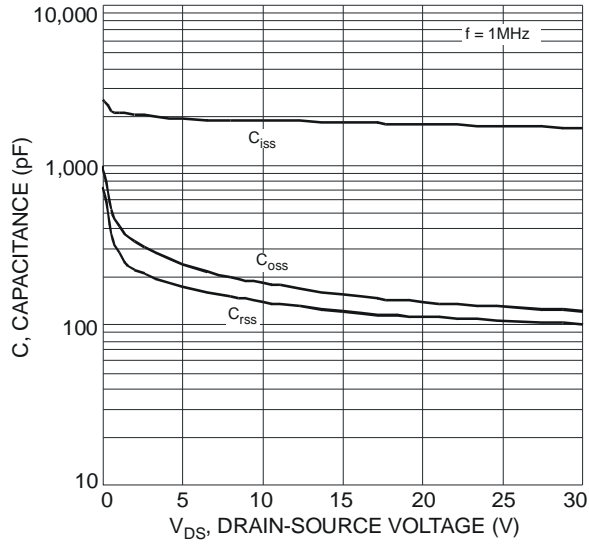

Fig. 8 Diode Forward Voltage vs. Current



Ordering Information (Note 8)

Part Number	Case	Packaging
DMS3016SSS-13	SO-8	2500 / Tape & Reel

Notes: 8. For packaging details, go to our website at <http://www.diodes.com/datasheets/ap02007.pdf>.

Marking Information

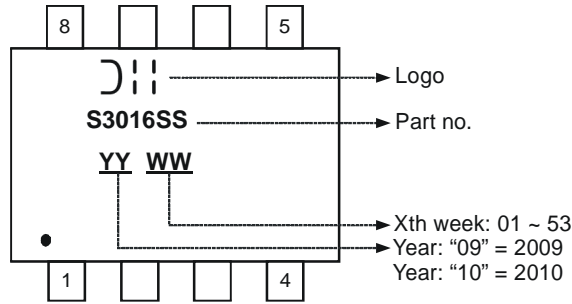

Package Outline Dimensions

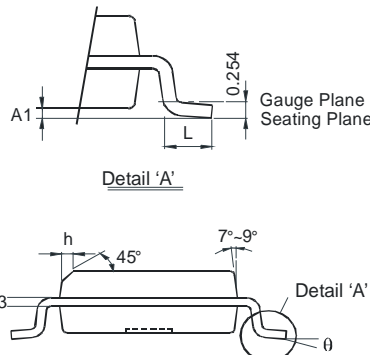
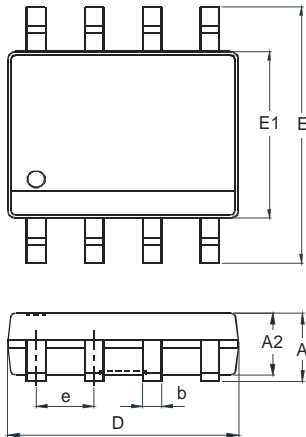

SO-8		
Dim	Min	Max
A	-	1.75
A1	0.10	0.20
A2	1.30	1.50
A3	0.15	0.25
b	0.3	0.5
D	4.85	4.95
E	5.90	6.10
E1	3.85	3.95
e	1.27 Typ	
h	-	0.35
L	0.62	0.82
θ	0°	8°
All Dimensions in mm		

Suggested Pad Layout

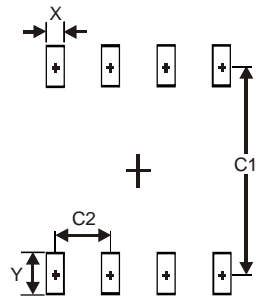

Dimensions	Value (in mm)
X	0.60
Y	1.55
C1	5.4
C2	1.27

IMPORTANT NOTICE

DIODES INCORPORATED MAKES NO WARRANTY OF ANY KIND, EXPRESS OR IMPLIED, WITH REGARDS TO THIS DOCUMENT, INCLUDING, BUT NOT LIMITED TO, THE IMPLIED WARRANTIES OF MERCHANTABILITY AND FITNESS FOR A PARTICULAR PURPOSE (AND THEIR EQUIVALENTS UNDER THE LAWS OF ANY JURISDICTION).

Diodes Incorporated and its subsidiaries reserve the right to make modifications, enhancements, improvements, corrections or other changes without further notice to this document and any product described herein. Diodes Incorporated does not assume any liability arising out of the application or use of this document or any product described herein; neither does Diodes Incorporated convey any license under its patent or trademark rights, nor the rights of others. Any Customer or user of this document or products described herein in such applications shall assume all risks of such use and will agree to hold Diodes Incorporated and all the companies whose products are represented on Diodes Incorporated website, harmless against all damages.

Diodes Incorporated does not warrant or accept any liability whatsoever in respect of any products purchased through unauthorized sales channel. Should Customers purchase or use Diodes Incorporated products for any unintended or unauthorized application, Customers shall indemnify and hold Diodes Incorporated and its representatives harmless against all claims, damages, expenses, and attorney fees arising out of, directly or indirectly, any claim of personal injury or death associated with such unintended or unauthorized application.

Products described herein may be covered by one or more United States, international or foreign patents pending. Product names and markings noted herein may also be covered by one or more United States, international or foreign trademarks.

LIFE SUPPORT

Diodes Incorporated products are specifically not authorized for use as critical components in life support devices or systems without the express written approval of the Chief Executive Officer of Diodes Incorporated. As used herein:

A. Life support devices or systems are devices or systems which:

1. are intended to implant into the body, or
2. support or sustain life and whose failure to perform when properly used in accordance with instructions for use provided in the labeling can be reasonably expected to result in significant injury to the user.

B. A critical component is any component in a life support device or system whose failure to perform can be reasonably expected to cause the failure of the life support device or to affect its safety or effectiveness.

Customers represent that they have all necessary expertise in the safety and regulatory ramifications of their life support devices or systems, and acknowledge and agree that they are solely responsible for all legal, regulatory and safety-related requirements concerning their products and any use of Diodes Incorporated products in such safety-critical, life support devices or systems, notwithstanding any devices- or systems-related information or support that may be provided by Diodes Incorporated. Further, Customers must fully indemnify Diodes Incorporated and its representatives against any damages arising out of the use of Diodes Incorporated products in such safety-critical, life support devices or systems.

Copyright © 2010, Diodes Incorporated

www.diodes.com



LittleDiode supplies new, hard to find or obsolete electronic components and semiconductors all over the world.

With over two million different components listed you are sure to find the part you need.

Feel free to visit us today at our online store:

LittleDiode.com

Looking forward to providing you with the best possible service.